

ETX-12P

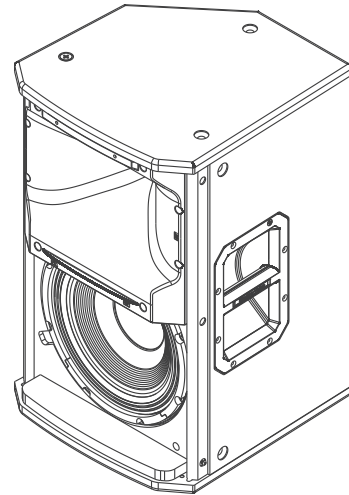

Electro-Voice

- 2000 W amplifier and 135 dB peak SPL
- Single-knob DSP includes presets for multiple configurations and top+sub combinations (performance style, locations, and space)
- Loudspeaker system performance monitoring via integrated LCD and front panel LED
- SST design assures precise and consistent coverage
- Designed for floor, stacked, or tilt pole mount (0 or 7.5 degrees) for portable or permanent installation (Eight (8) M10 threaded suspension points)



ETX-12P from Electro-Voice is a high-power two-way compact loudspeaker; it can be used in a variety of portable and permanent applications. The DSP (Digital Signal Processing) menus offer extensive configurations, crossovers, selective voicing, protection limiters, EQ modes, and a lockout mode prevents casual changes to the system. Loudspeaker system performance is optimized via an LCD screen. The front LED indicates power or can be configured to indicate limit.

EV-patented SST (Signal Synchronized Transducers) waveguide design provides uniform coverage and directivity. Waveguides are optimized using advanced simulation software and propriety algorithms for precise control and lowest distortion. EV designed and manufactured transducers include SMX woofer technology using composite cone materials, flux stabilizing rings, and thermal management. This transducer yields lower distortion, smooth response and high SPL. The high-efficiency DH3-B compression driver has a convex diaphragm driving a coherent phase device extending frequency response to 20 kHz. EV's FIR-Drive technology utilized the latest FIR (Finite Impulse Response) filter technology to optimize transducer linearity and advanced limiter algorithms for independent peak and thermal transducer protection. The enclosure is constructed out of 18-mm, 13-ply birch plywood finished with EVCoat. ETX Powered Loudspeakers combine EV-engineered intelligent DSP, high-powered amplifiers and high-efficiency transducers to deliver that legendary EV sound and performance.

Technical specifications

Frequency Response (-3 dB):	55 Hz – 20 kHz ¹
Frequency Range (-10 dB):	43 Hz – 20 kHz ¹
Maximum SPL:	135 dB peak ²
Coverage (H x V):	90° x 60°
Power Rating:	2000 W
LF Transducer:	SMX2120 300 mm (12 in)
HF Transducer:	DH3-B 1.25-in titanium compression driver
Crossover Frequency:	1600 Hz
Connectors:	(2) XLR/TRS combo jack and (1) XLR link output
Enclosure:	18 mm, 13-ply birch plywood with EVCoat
Grille:	16AWG steel with powdercoat
Suspension:	(8) M10 suspension points
Dimensions (H x W x D):	613 mm x 381 mm x 400 mm (24 in x 15 in x 16 in)
Net Weight:	23.6 kg (52.0 lb)
Shipping Weight:	26.8 kg (59.1 lb)
Power Consumption:	100 – 240 V~, 50 – 60 Hz, 1.6 – 0.8A ³

1. Full space measurement using the music DSP preset.
2. Maximum SPL is measured at 1 m using broadband pink noise at maximum output.
3. Current rating is 1/8 power.

System overview

Frequency response:

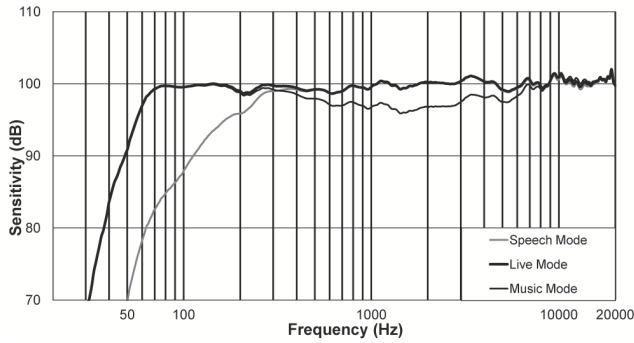

Caution!

This Electro-Voice loudspeaker should be suspended overhead only in accordance with the procedures and limitations specified in the User's Manual and possible manual update notices. This system should be suspended with certified rigging hardware by an authorized rigging professional and in compliance with local, state, and federal overhead suspension ordinances.



Full-Range loudspeaker amplifier panel:

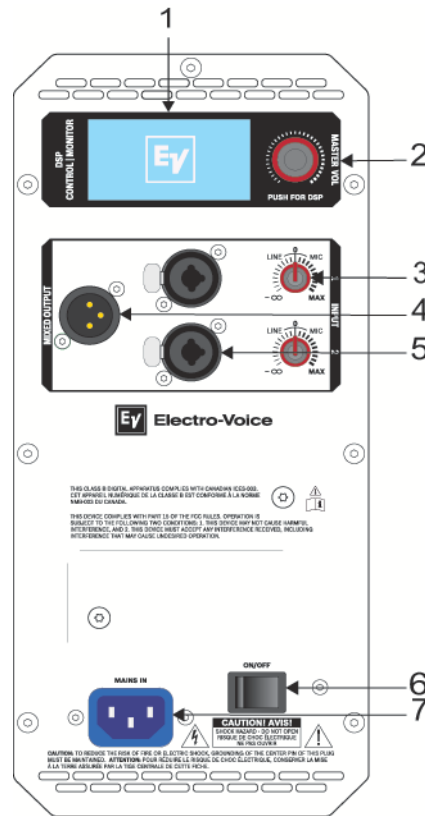

1. LCD
2. MASTER VOL/DSP
3. INPUT LEVEL
4. INPUT
5. MIXED OUTPUT
6. POWER
7. MAINS IN

For more information, see the user manual.

Dimension drawing:

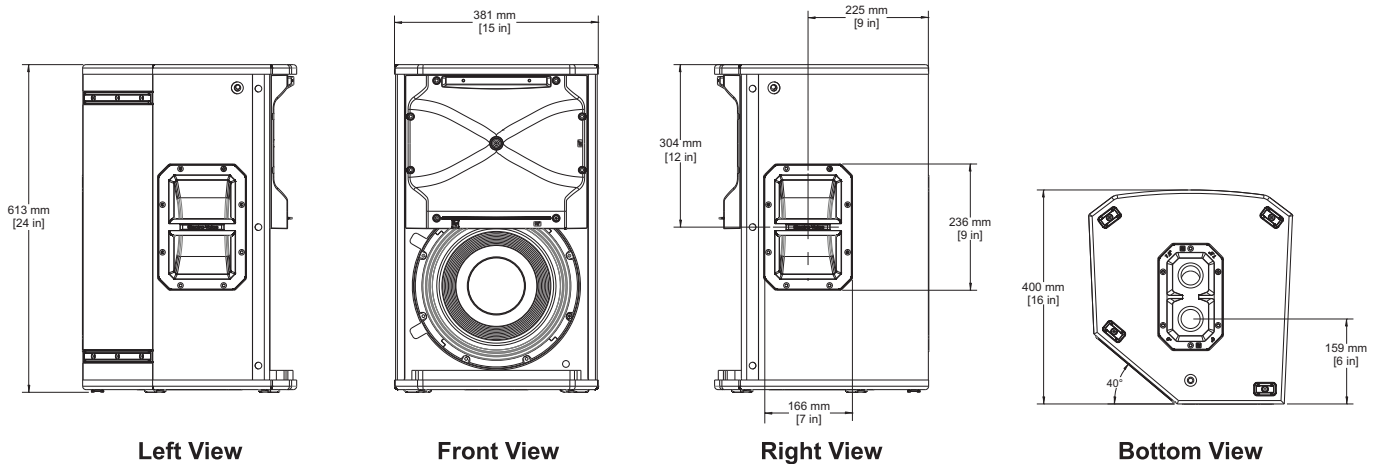

Ordering information

ETX-12P US

12-inch 2-way powered loudspeaker, black, US 120V

Order number **ETX-12P-US**

ETX-12P EU

12-inch 2-way powered loudspeaker, black, EU 240V

Order number **ETX-12P-EU**

Accessories

ETX-12P Wall Mount Bracket

Wall mount bracket for ETX-12P, black

Order number **ETX-BRKT12**

ETX-12P, ETX-15P, and ETX-35P Truss Adaptor

Truss adaptor for ETX-12P, ETX-15P, and ETX-35P,
black

Order number **ETX-TCA-L**

ETX-12P Cover

Padded cover for ETX-12P, EV logo

Order number **ETX-12P-CVR**

Represented by:

Germany:

Bosch Sicherheitssysteme GmbH
Robert-Bosch-Ring 5
85630 Grasbrunn
Germany

Bosch Security Systems, Inc.
12000 Portland Avenue South
Burnsville MN 55337
USA

www.electrovoice.com