



Sigma

Remote-Controlled Analogue Mix Engine

User Guide

Table of Contents

1. Introduction	5
About this User Guide	5
Sigma Overview	5
What is Sigma and what was the idea behind it?	5
How do I operate Sigma?	5
How does Sigma work?	6
2. Hardware Installation	7
Installation Overview	7
Front Panel	8
Rear Panel	9
CHIP (Channel inputs) and CHOP (Channel direct outputs)	10
Miscellaneous Connections	10
3. Software Installation and Configuration	11
1) ipMIDI Software	11
ipMIDI Installation - Macintosh	11
ipMIDI Installation - Windows	12
2) Install web browser	12
3) Install Flash	12
Sigma's Internal Software	12
4. Network Setup	13
General	13
Sigma's IP Address	13
Useful Built-In Features	13
Network Connection Examples	14
1. Fixed IP – Direct Connection	14
2. Router (and Switch) Connection using DHCP - Allows Access to Internet	16
3. Connection in a facility that has multiple SSL Consoles/Multiple ipMIDI devices	18
Controlling Sigma With A Tablet / Smartphone	18
Connecting to Sigma using an iPad via a Wireless Router	18
5. Connecting to and Using Sigma	22
Connecting using a Fixed IP address	22
Connecting using DHCP	23
Macintosh Users (must use Safari)	23
Windows Users	24
The web browser interface	25

Document History:

82BMSM01A Initial Release August 2013

MASTER	26
Master Meter	26
Mix Bus Inserts	26
Level Control	26
B TO A Function	27
USER Buttons	27
MON Box	27
H/P Box	28
MIDI LEARN	28
FOOTSWITCH	28
DIM SETTINGS	28
iJack Input	28
CHANNELS	29
GLOBAL SETUP	30
SETTINGS	31
SETUP Box	31
NETWORK Box	33
MISC Box	33
SAVE and LOAD Buttons	35
6. Example Setups	36
Pro Tools + Sigma (No Control Surface)	36
Sigma Browser Settings	36
Pro Tools Settings	37
Pro Tools Session Setup	37
Pro Tools + Sigma + Nucleus (or any standard HUI Control Surface)	38
Sigma Browser Settings	38
Pro Tools Settings	39
Pro Tools Session Setup	40
Pro Tools + Sigma + Avid® Artist Series Control Surface (Eucon)	41
Sigma Browser Settings	41
Pro Tools Settings	42
Artist Controller Settings	42
Pro Tools Session Setup	43
Logic + Sigma (No Control Surface)	44
Sigma Browser Settings	44
Logic Settings	45
Logic Session Setup	46
Logic + Sigma + Nucleus (or any standard MCU Control Surface)	47
Sigma Browser Settings	47
Logic Control Surface Settings	48
Logic Control Surface Preferences	49
Logic Session Setup	49

Logic + Sigma + Avid® Artist Series Control Surface (Eucon)	50
Sigma Browser Settings	50
Artist Controller Settings	50
Logic Control Surface Settings	51
Logic Session Setup	52
Cubase/Nuendo + Sigma (No Control Surface)	53
Sigma Browser Settings	53
Cubase/Nuendo Settings	54
Session Setup	54
Cubase/Nuendo + Sigma + Nucleus (or any standard MCU Control Surface)	55
Sigma Browser Settings	55
Cubase/Nuendo Settings	56
Cubase Session Setup	57
Cubase/Nuendo + Sigma + Avid® Artist Series Control Surface (Eucon)	58
Sigma Browser Settings	58
Cubase/Nuendo Settings	59
Artist Controller Settings	60
Cubase/Nuendo Session Setup	60
Ableton Live! + Sigma (No Control Surface)	61
Sigma Browser Settings	61
Ableton Live! Settings	62
Ableton Live! Session Setup	62
Ableton Live! + Sigma (With MCU Control Surface)	63
Using Sigma with other DAWs	63
Sigma Browser Settings	63
Session Setup	64
Using Two Sigmas together	65
Appendices	66
Appendix A - Connectors & Pinouts	66
Appendix B - Signal Flow Block Diagram	67
Appendix C - Support	68
FAQs	68
Required Software	69
Sigma's Internal Software	69
Hardware	70
Appendix D	71
Specifications - Technical & Environmental	71
Appendix E	71
Limited Warranty	71

1. Introduction

ABOUT THIS USER GUIDE

Congratulations on purchasing your Solid State Logic Sigma. This User Guide will help you to configure Sigma for your studio. We've included a range of setup examples, so connecting and configuring Sigma to suit your workflow couldn't be easier.

This User Guide is arranged into the following sections:

Introduction	An overview of Sigma's features.
Hardware Installation	This section provides information on Sigma's physical connections and how to connect them to your existing studio equipment.
Software Installation	This section lists all of the required software needed in order to make Sigma work with your DAW.
Network Setup	This section guides you through configuring Sigma to work on your computer network and tablet/smartphone.
Connecting to and Using Sigma	This section details how to operate Sigma and discusses control from the web browser.
Example Setups	This section provides some "real world" examples of how to configure Sigma in various setups. This includes how to arrange your DAW session to work with Sigma.
Appendices	Contains additional documentation for reference.

SIGMA OVERVIEW

What is Sigma and what was the idea behind it?

Sigma is a 2U, remote-controllable analogue mix engine. Sigma has 16 stereo/mono inputs and outputs, 2 mix buses (A and B), mix bus insert points, comprehensive monitoring, a talkback input and customisable user buttons. The idea of Sigma was to bring the sound of an SSL console together with all the workflow advantages of mixing in a DAW. Sigma is built upon the same Superanalogue technology as our Duality and AWS consoles. Superanalogue circuit design gives you an extended frequency response, precise stereo imaging, clarity and depth. Sigma is designed for the professional looking to add that extra 10% to their sound, that even the best plug-in emulation cannot achieve.

Sigma features LED metering on all 16 channel strips and an additional high resolution stereo master meter. The blue rotary encoder is switchable (via a push function) between controlling the following levels: control room monitor level, headphones, Mix Bus A and Mix Bus B master "fader" gains.

Many features on Sigma can be controlled using a MIDI learn. This means that you can use a generic MIDI controller to do a number of things from controlling the monitor level, to switching Mix Insert points in/out.

How do I operate Sigma?

All of Sigma's controls can be accessed through the web browser interface. The **CHANNELS** page is used to configure each of Sigma's 16 channels, whilst the **MASTER** page is used to configure the monitoring section and other features including User buttons and MIDI Learn functionality. The **SETTINGS** page provides additional configuration options. The web browser interface means you can also control Sigma from a tablet or smartphone.

How does Sigma work?

Sigma works by using faders in your DAW as analogue gain controls. Sigma communicates with your DAW in the same way a control surface does, but instead uses the DAW's fader positions to control the gain of 16 analogue "faders". The automation in your DAW session can be used to "ride" the levels of an analogue mix, bringing together the efficiency of a DAW automation system with the sound of your favourite analogue outboard equipment.

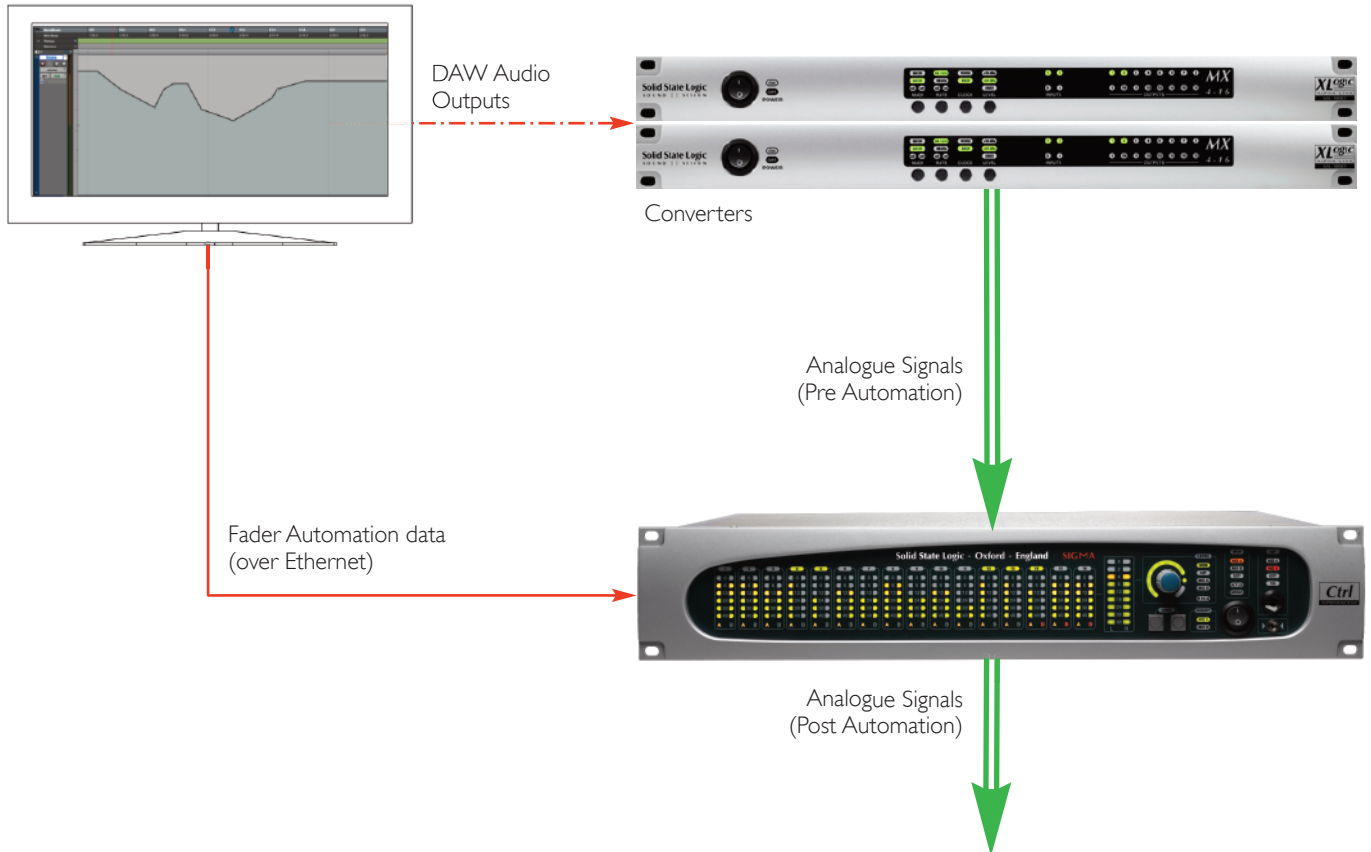

The picture above is intended to give a graphical representation of how DAW automation controls Sigma's analogue gains.

1. Automation data is generated in the DAW.
2. This data is sent over the ethernet cable from your computer into Sigma, via the relevant protocol (HUI/MCU/MIDI).
3. Sigma takes the DAW automation and transforms it into analogue gain changes. This is done using MDAC technology. Think of MDACs as the "virtual faders" within each channel of Sigma.

Note: MDAC stands for Multiplying Digital to Analogue Converter. MDAC technology is used in the Duality and AWS consoles.

2. Hardware Installation

INSTALLATION OVERVIEW

The diagram below gives you an idea of how Sigma connects to your other studio gear.

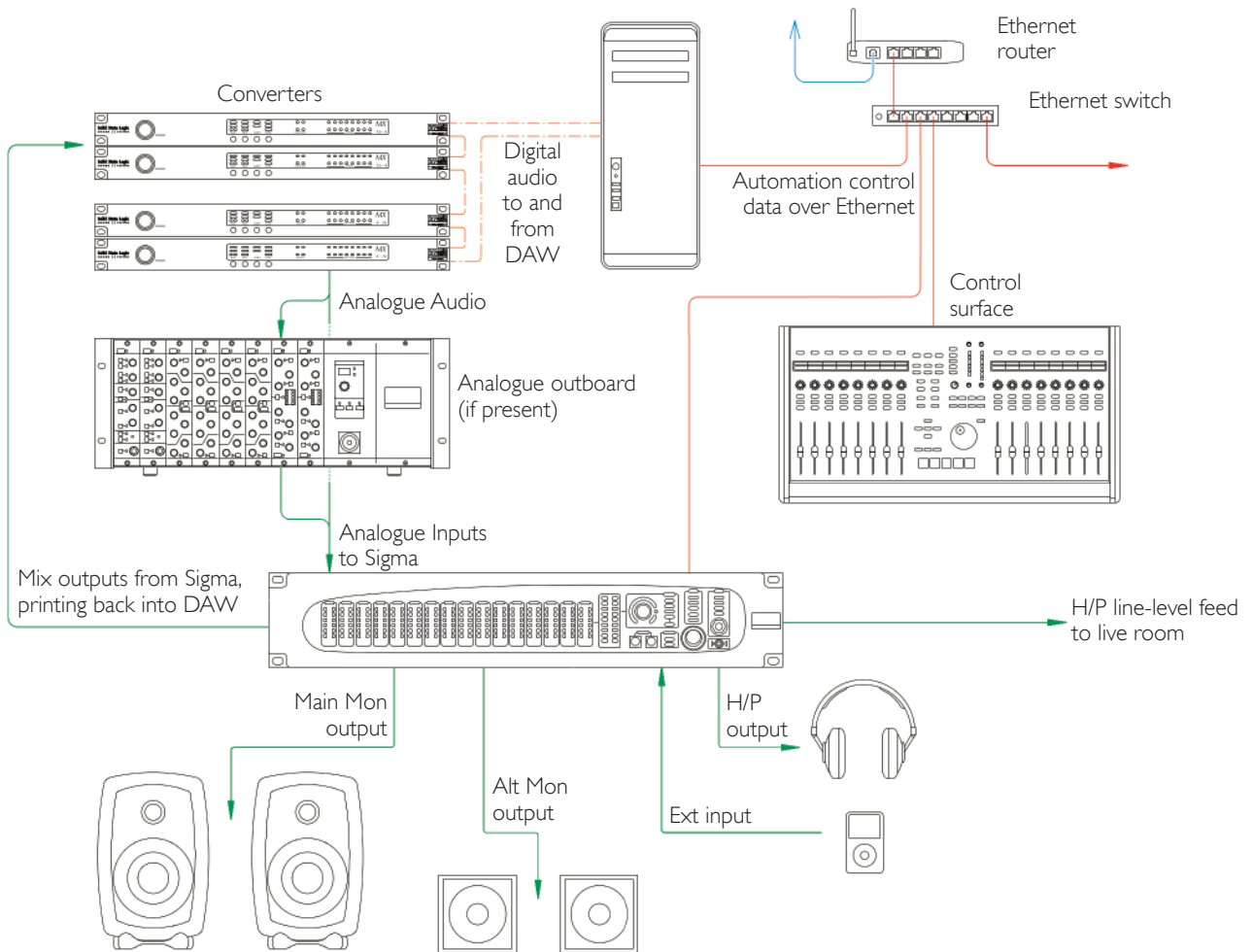

FRONT PANEL

Sigma provides you with 16 stereo line inputs and 16 stereo line outputs on Tascam standard (AES59) 25-pin D-sub connectors. Using the web browser interface, the left input of each stereo channel can be selected as a mono source. When an input is set to mono, the channel number on the front panel will glow green.

Please note that setting an input to mono does not give you 2 independent mono inputs!

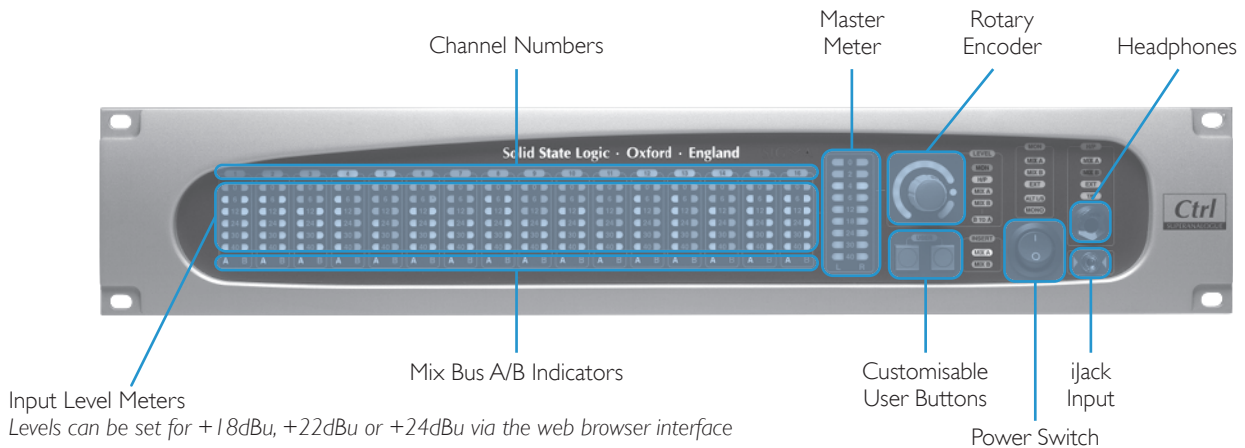

Headphones - stereo headphone output on 1/4" jack.

Important - For health and safety reasons, do not reboot Sigma with while monitoring through headphones.

iJack Input - stereo external input on 1/8" jack (from iPod output or similar device).

Sigma also provides access to Mix Insert Send>Returns, a Line Level output for sending headphone feeds into a live room, an external input and talkback input, all on standard DB-25 connections. Access to the Main Speaker Outputs, Alternative Speaker Outputs and the Mix A Output is provided on XLR male connectors.

REAR PANEL

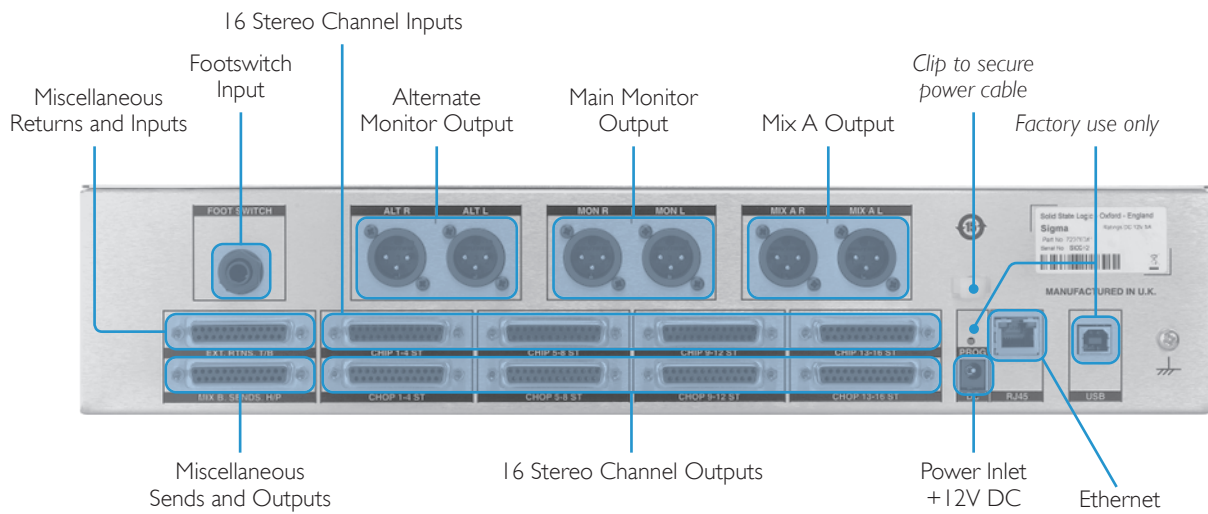

ALT R - Alternate right monitor output.
ALT L - Alternate left monitor output.

MON R - Right monitor output.
MON L - Left monitor output.

MIX A R - Mix Bus A right output.
MIX A L - Mix Bus A left output.

FOOTSWITCH - The footswitch input is suitable for any 1/4" on/off footswitch. By default this turns Talkback On/Off, although this can be changed in the web browser.

DC - Use with the provided power supply - the clip above the power inlet should be used to retain the power lead and so prevent accidental removal or damage.

RJ45 - Use a standard Ethernet cable (as supplied) to connect Sigma to your computer network.

USB and PROG - The USB socket and PROG switch are for SSL diagnostic use and should not be connect or used.

CHIP (CHANNEL INPUTS) AND CHOP (CHANNEL DIRECT OUTPUTS)

All inputs and outputs for Sigma are on AES 59 'Tascam' standard D-Sub connectors. Each D-Sub carries up to four stereo signals. The inputs and outputs are all operating at line-level. The direct channel outputs are sourced *post-fader*.

Typically, you would connect the outputs from your D/A converter into the CHIPS.

The CHOPs would be connected to your A/D to record back into the DAW.

A creative use for Sigma could be using it to automate an analogue desk. This could be achieved by connecting the insert sends from the console into Sigma's CHIPS and then connecting Sigma's CHOPs into the insert returns of the console.

MISCELLANEOUS CONNECTIONS

EXT, RTNS, TB - AES 59 'Tascam' standard connections:

- EXT** - Provides a line-level stereo input available from an external source such as a professional CD player.
- RTNS (A + B)**- Provides connections for the stereo insert return signals of both Mix Bus A and Mix Bus B.
- TB** - Provides a line-level input from which you can connect the output from a talkback microphone preamplifier.

MIX B, SENDS, H/P - AES 59 'Tascam' standard connections.

- MIX B** - Stereo Mix Bus B outputs
- SENDS** - Provides connections for the stereo insert send signals of both Mix Bus A and Mix Bus B.
- H/P** - Provides a line-level stereo headphone output suitable for running a headphone feed into a cue mixer.

EXT, RTNS, T/B †			<i>D-sub to XLR-F Loom</i>
Connector Type: 25-way D-type Female			
Pin	Description		
1	n/c		
14	n/c		XLR-8
2	0V		
15	Talkback Mic Input (+ve)		
3	Talkback Mic Input (-ve)		XLR-7
16	0V		
4	Mix B Insert Return Right (+ve)		
17	Mix B Insert Return Right (-ve)		XLR-6
5	0V		
18	Mix B Insert Return Left (+ve)		
6	Mix B Insert Return Left (-ve)		XLR-5
19	0V		
7	Mix A Insert Return Right (+ve)		
20	Mix A Insert Return Right (-ve)		XLR-4
8	0V		
21	Mix A Insert Return Left (+ve)		
9	Mix A Insert Return Left (-ve)		XLR-3
22	0V		
10	External Input Right (+ve)		
23	External Input Right (-ve)		XLR-2
11	0V		
24	External Input Left (+ve)		
12	External Input Left (-ve)		XLR-1
25	0V		
13	n/c		

MIX B, SENDS, H/P †			<i>D-sub to XLR-M Loom</i>
Connector Type: 25-way D-type Female			
Pin	Description		
1	Headphone Right (+ve, line level)		
14	Headphone Right (-ve, line level)		XLR-8
2	0V		
15	Headphone Left (+ve, line level)		
3	Headphone Left (-ve, line level)		XLR-7
16	0V		
4	Mix B Insert Send Right (+ve)		
17	Mix B Insert Send Right (-ve)		XLR-6
5	0V		
18	Mix B Insert Send Left (+ve)		
6	Mix B Insert Send Left (-ve)		XLR-5
19	0V		
7	Mix A Insert Send Right (+ve)		
20	Mix A Insert Send Right (-ve)		XLR-4
8	0V		
21	Mix A Insert Send Left (+ve)		
9	Mix A Insert Send Left (-ve)		XLR-3
22	0V		
10	Mix B Output Right (+ve)		
23	Mix B Output Right (-ve)		XLR-2
11	0V		
24	Mix B Output Left (+ve)		
12	Mix B Output Left (-ve)		XLR-1
25	0V		
13	n/c		

3. Software Installation and Configuration

Sigma requires the following software to be installed on your computer:

- ipMIDI software - To carry the automation data from your DAW to Sigma's channels.
- A web browser (Chrome/Firefox/Safari/Internet Explorer) - To configure your Sigma.
- Flash - The 'Save' and 'Load' buttons in the web browser require Flash.

1) ipMIDI SOFTWARE

There is no disk included with Sigma. In order to install the ipMIDI software, you need to go to the SSL website, navigate to the Sigma product page (within 'Music' products) and click on the 'Downloads' tab. Follow the onscreen instructions to download your Sigma Support File, containing all necessary software.

During the registration process you will be prompted for your Sigma serial number, which you will find on the white label on the rear of your Sigma unit.

ipMIDI Installation - Macintosh

After downloading the Sigma Mac Support File from the Downloads section, install the ipMIDI.dmg file. Note that you will be asked to logout and in again once you have completed the installation. Once you have logged back in open **Audio MIDI Setup** (in the **Utilities** folder on your Mac) and double click on the ipMIDI icon (in MIDI Window view). Set the number of ports to 20 in the resulting pop-up.

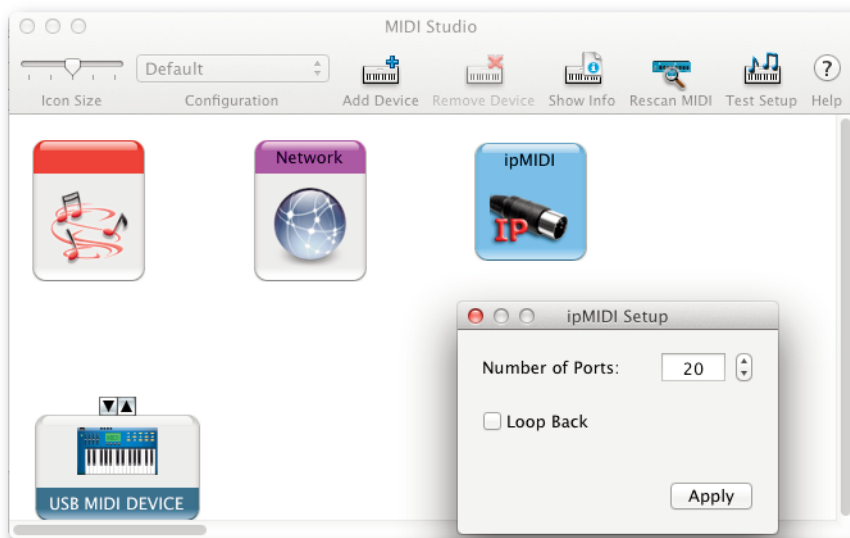

There are two version of ipMIDI for Mac; V1.5 is suitable for OS X 10.5 whilst V1.6 runs on OS X 10.6 upwards. Please choose the correct version for your Mac.

Note that if you are upgrading an older copy of ipMIDI you must uninstall it before running the installer. To uninstall ipMIDI simple delete: '/Library/Audio/MIDI Drivers/ipMIDIDriver.plugin'. You should empty the Trash after deleting the '.plugin' file before running the installer.

ipMIDI Installation - Windows

After downloading the Sigma Windows Support File from the downloads page, install the ipMIDI.exe. Note that you will have to restart the computer at the end of the setup process. Once the computer has restarted, double-click on the ipMIDI icon in the bottom-right taskbar of Windows and set the number of MIDI ports to 20 in the resulting pop-up.

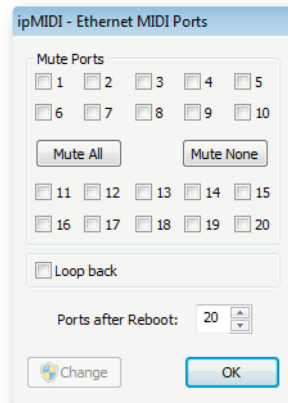

*Note that if you are upgrading an older copy of ipMIDI you must uninstall (using **Add/Remove programs**) it before running the installer.*

2) INSTALL WEB BROWSER

Sigma is configured through your web browser. Please ensure you have one of the following installed on your computer:

- Google Chrome
- Firefox
- Safari
- Internet Explorer

Important: Please check the SSL website for tested web browser versions and compatability.

Out of the box, Sigma comes preconfigured with a fixed IP address. This can be changed to DHCP in the settings if required. Therefore, the first time you connect to Sigma should be through a direct ethernet connection between Sigma and your computer (see Network setup information for more information).

3) INSTALL FLASH

The **SAVE** and **LOAD** buttons in the web browser require Flash to be installed. Please go to the Adobe Flash website to make sure you have the latest version of Flash installed:

<http://get.adobe.com/flashplayer>

SIGMA'S INTERNAL SOFTWARE

Sigma has internal software that comes pre-installed from the factory. There may be infrequent updates for this software. Please refer to *Chapter 5 'Software Update & Reboot Button'* for more information on how to check your Sigma software version and updating the software.

4. Network Setup

GENERAL

Sigma communicates with your DAW over a standard Ethernet cable using the ipMIDI software driver to emulate a multi-port MIDI interface. To ensure minimum latency ipMIDI uses multicast UDP rather than TCP/IP.

Routers that support high data transfer rates should be used. Some domestic routers have experienced problems, so please check your router specification if problems occur.

Notes for Network Technicians:

Because ipMIDI uses multicast UDP packets, messages between one computer and Sigma will be received by all other computers on the network potentially causing problems with other ipMIDI devices on your network. The UDP packets can be blocked by using a firewall router and connecting the main network by the WAN connector. The firewall can then be configured to allow all traffic apart from UDP ports 21928 through 21947 which are used by ipMIDI. Note that it may be necessary to use a separate Ethernet switch in place of an integrated firewall router switch, as some of these can not support the ihg data transfer rate required. The NetGear GS108 (an eight port switch) has been used successfully at SSL Begbroke.

You can purchase a pre-configured LAN Integration Network Switch from the SSL web store. See setup example 3 for more details.

Sigma's IP Address

By default, Sigma uses a fixed IP address of 192.168.1.201/sigmaweb. Alternatively, Sigma can be set to use a dynamically assigned (DHCP) address if your installation precludes a simple direct connection. Switching between the two options is done in Sigma's **SETTINGS** page in your web browser. See 'Connecting to and Using Sigma' chapter for more information.

Useful Built-In Features

Reverting from DHCP to Fixed IP

If a situation arises where Sigma is set to DHCP but you are unable to connect via a DHCP, take the following steps:

- 1) Power Sigma off
- 2) Set your computer network settings to be a fixed IP address
- 3) Power Sigma on

This will force Sigma into reverting to its fixed IP address.

How to check the current IP address of Sigma

Once connected to Sigma, it is possible to change the fixed IP address as desired. In a situation where you forget what the fixed IP address is set to, press and hold the first **USER** button on the front panel and whilst keeping this held down, press the second **USER** button. Sigma will use the front panel LEDs to readout the IP address it is set to.

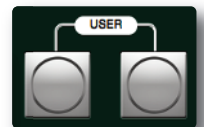

NETWORK CONNECTION EXAMPLES

1. Fixed IP – Direct Connection

This is the simplest way to setup Sigma with your computer. Sigma comes configured to use a fixed IP on first startup.

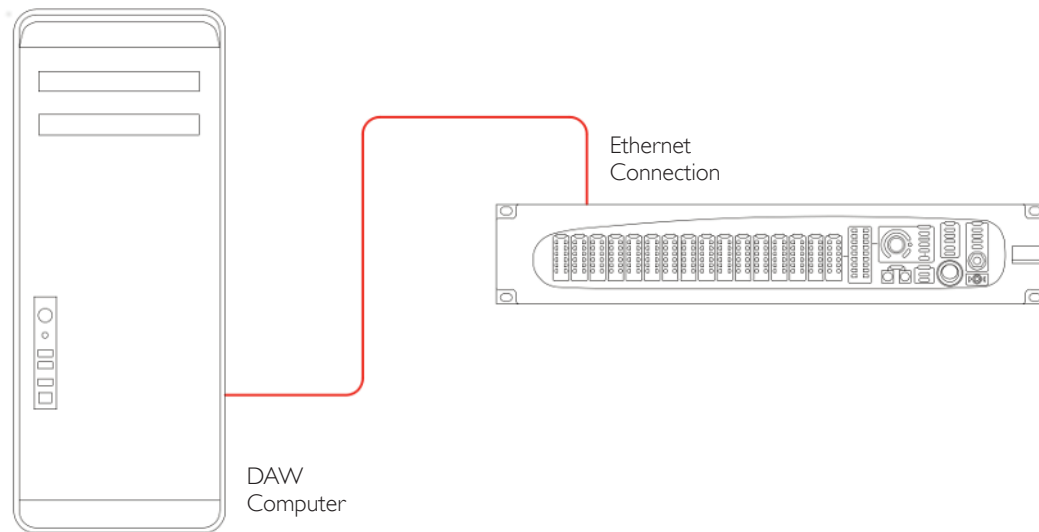

Please note that Macintosh computers with multiple Ethernet ports can only use one of those ports at any one time!

If you are using a Macintosh computer, you should ensure that Airport is switched off. We strongly recommend this as Airport is known to cause conflicts with ipMIDI data and may stop Sigma from working. If you wish to use the internet, we suggest you configure Sigma with a Router/Switch (see example 2).

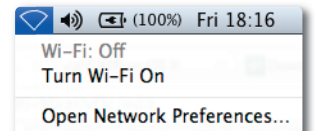

Network Connection Configuration - Macintosh

- On your computer go to **System Preferences** and click on the **Network** icon.
- Set **Configure IPv4 to Manually** then fill in the **IP Address** and **Subnet Mask** boxes with the numbers shown below. The IP address should be in the 192.168.1.X range with a Subnet of 255.255.255.0.

'X' should be a number between 3 and 254. Make sure that the 'X' number is not the same as Sigma's address and/or any other device on the network.

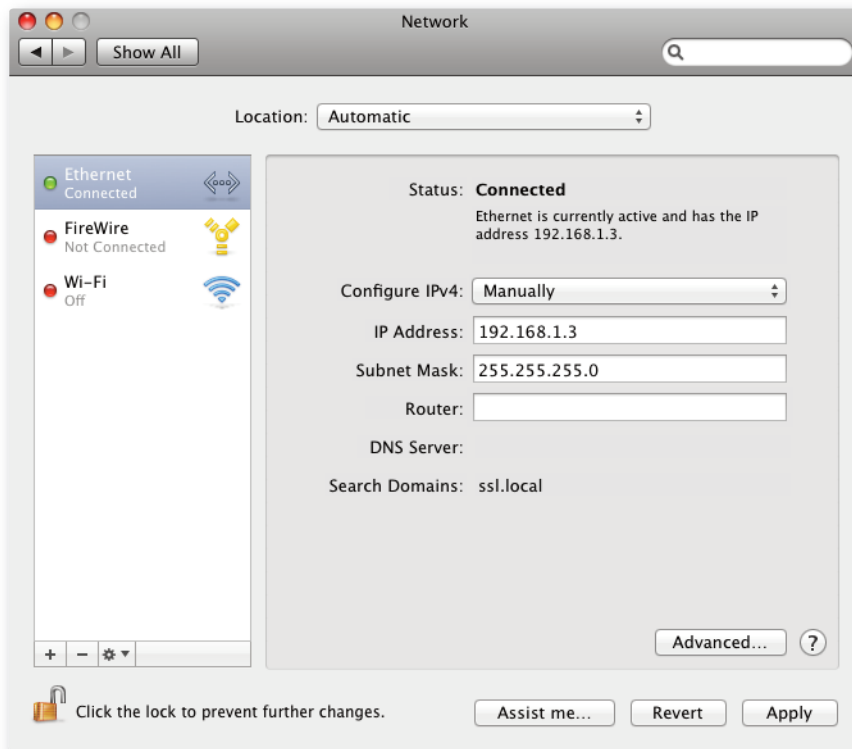

Network Connection Configuration - Windows

- Go to **Network** and go into **Local Area Connection Properties**.
- Open up the option **Internet Protocol Version 4 (TCP/IPv4)**.
- Select **Use the following IP address** and then fill in the **IP Address** and **Subnet mask** boxes as shown below.

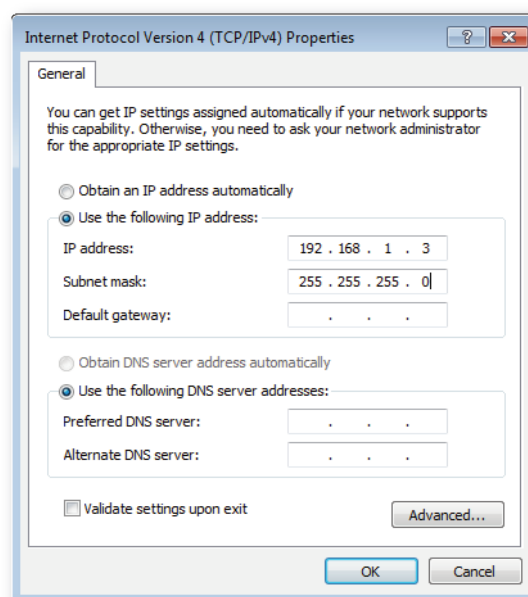

2. Router (and Switch) Connection using DHCP - Allows Access to Internet

This connection method allows you to connect multiple devices to your network and access the internet at the same time. The premise behind this method is that your Internet router acts as a DHCP server, dynamically assigning IP addresses to all the devices on your network. The simplest configuration would be as follows:

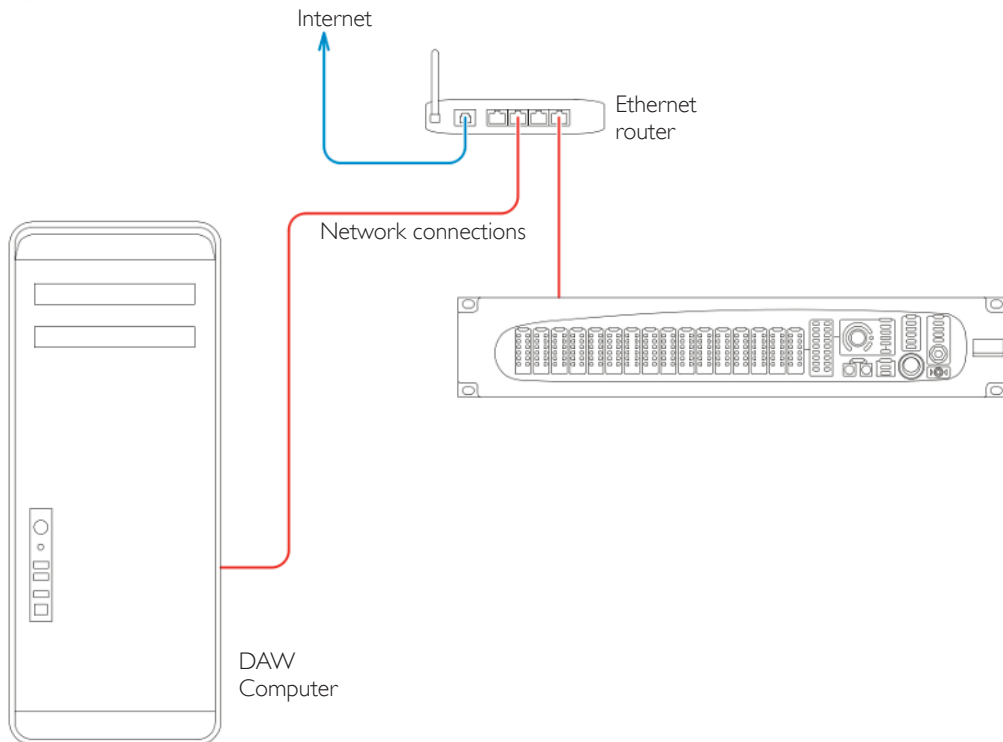

If you have more devices that you need to connect on your network, adding an Ethernet switch will allow more things to be connected.

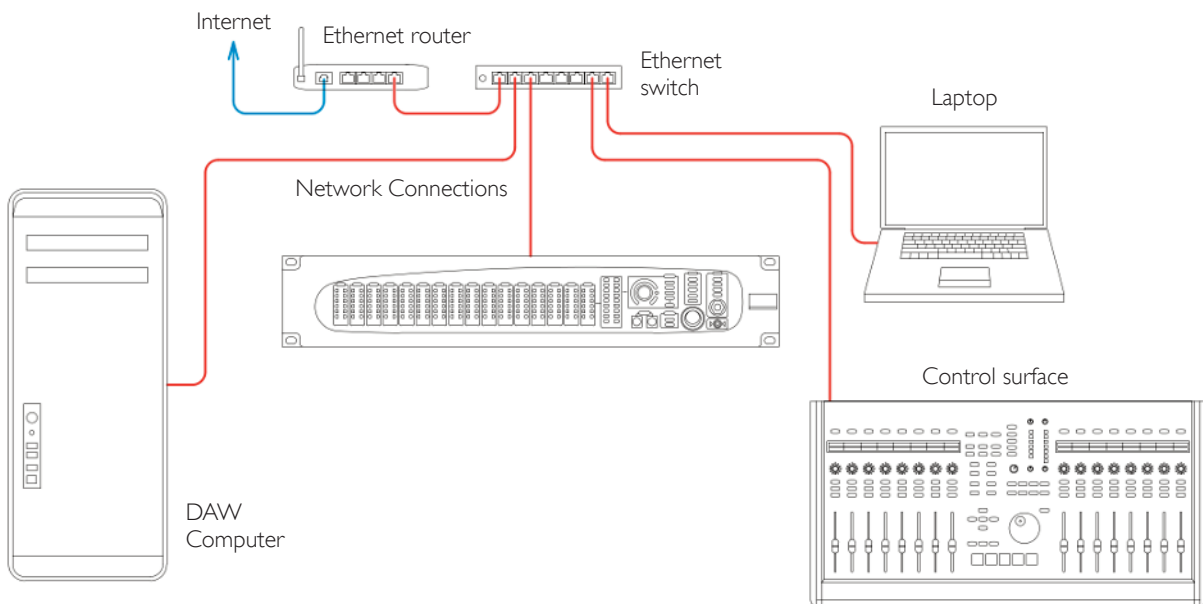

Network Connection Configuration - Macintosh

- On the Mac, go to **System Preferences** and click on the **Network** icon.
- Set **Configure IPv4** to **Using DHCP**.

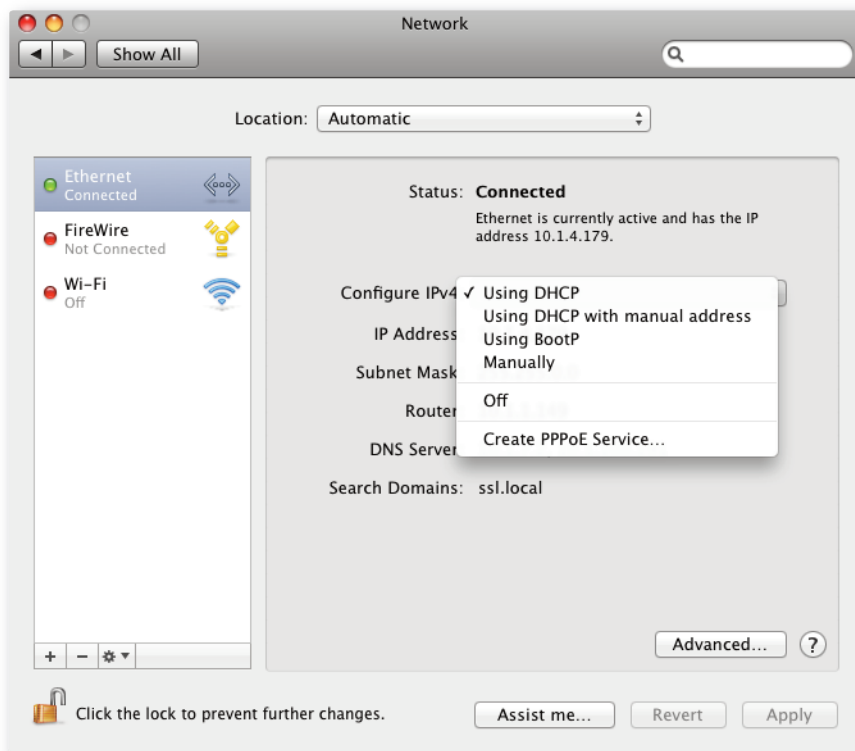

Network Connection Configuration - Windows

- Go to **Network** and go into **Local Area Connection Properties**.
- Open up the option **Internet Protocol Version 4 (TCP/IPv4)**.
- Choose the option **Obtain an IP address automatically**.

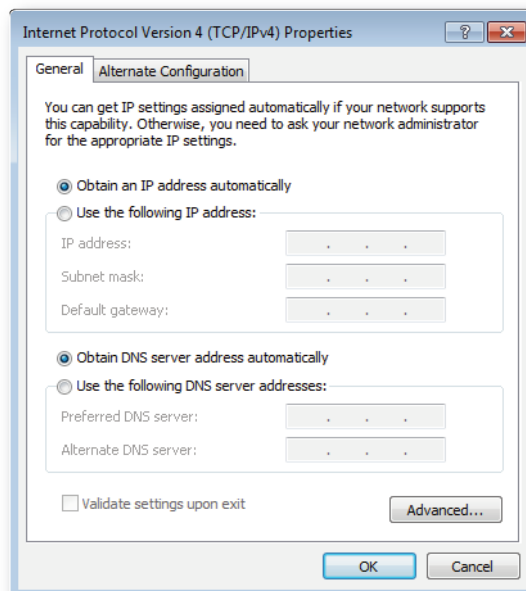

3. Connection in a facility that has multiple SSL Consoles/Multiple ipMIDI devices

If you are in a studio that has multiple SSL consoles/ipMIDI devices, we recommend that you purchase one of our 'LAN integration network switches' from the SSL web store. Due to the nature of UDP, if you have two SSL consoles/ipMIDI devices on the same network with a normal router/switch setup, then you may find that an ipMIDI device in one room will start affecting another ipMIDI devices in another room. Our managed switch blocks UDP data on two of the ports, solving the problem and allowing uplinking in a multi-room facility. Please visit the following link for more details and a picture example:

store.solidstatelogic.com/catalog/36.

CONTROLLING SIGMA WITH A TABLET / SMARTPHONE

You can use a tablet/smartphone device to control Sigma by using it to access the web browser. Before attempting to connect your tablet to Sigma, please ensure that you have established Sigma on your local area network, using one of the three methods detailed above.

In order for your tablet/smartphone to communicate with Sigma, **you will need a Wireless Router**. The Wireless Router will act as a bridge, connecting your tablet to Sigma.

Connecting to Sigma using an iPad via a Wireless Router

Fixed IP

1. Connect your iPad to your wireless router signal in (**Settings > WI-FI**)

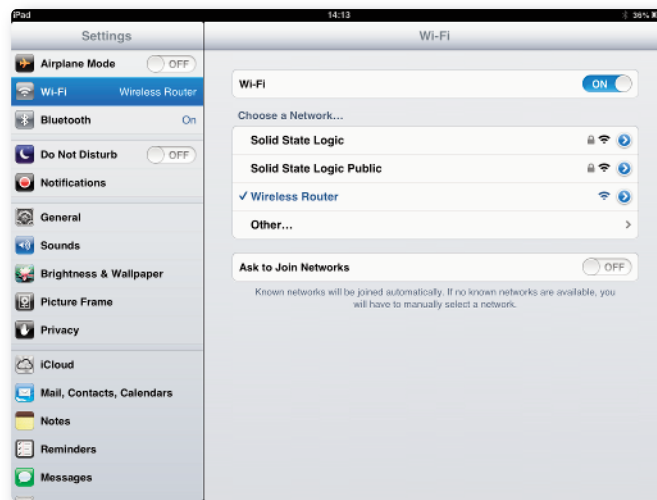

2. Launch web browser and type in Sigma's static IP address - 192.168.1.201/sigmaweb



DHCP Network

1. Connect your iPad to your wireless router in (**Settings > WI-FI**).

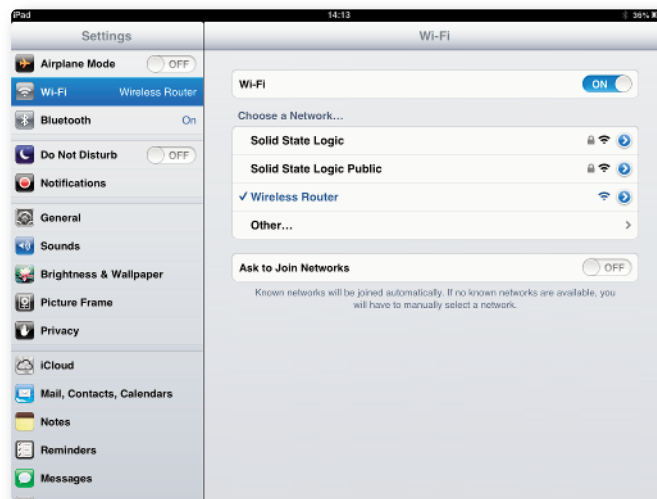

2. Download an app that allows you to see devices on your network. “My Devices” by Zoftware Design®, Inc is free to download. Please be aware that “My Devices” is an iPhone app that also works on iPad. **So in the iPad app store, make sure your search is set to iPhone Apps, not iPad apps.**

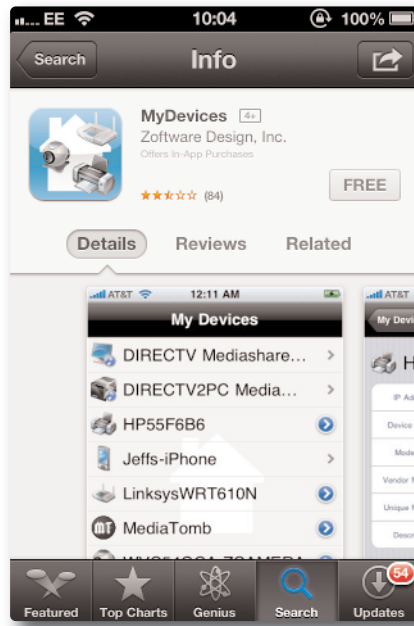

3. Go to **Settings > MyDevices** on your iPad. Ensure that all ‘Device Filters’ are **OFF**. Turn ‘Use Safari’ **ON** in ‘Web View’.

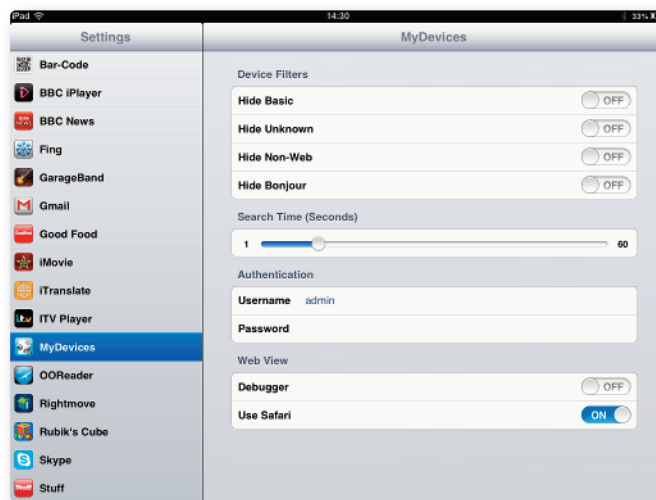

4. Launch app and and select your SSL Sigma device on the network.



5. The app should automatically open Safari and locate to the Sigma browser page.



Instead of using an app to access your Sigma device, you can type in Sigma's DHCP name address directly into the browser's address bar. As you can see from the above screenshot, in Safari, the address is made up of your Sigma's name followed by `.local/sigmaweb`. Spaces should be filled with an `'_'`.

Alternatively, you can type the actual IP address that Sigma is currently assigned to into your browser's address bar. Press and hold the first User button on the front panel and whilst keeping this held down, press the second User button. Sigma will use the front panel LEDs to readout the IP address it is set to.

It is recommended **not** to mix browsers between devices - e.g. running Safari on the iPad and Chrome on your main computer.

5. Connecting to and Using Sigma

CONNECTING USING A FIXED IP ADDRESS

Open your web browser and type the following into the address bar to connect via a fixed IP address:

192.168.1.201/sigmaweb

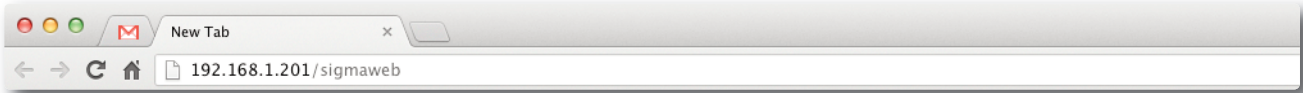

The first time you connect to Sigma must be through a Fixed IP connection between Sigma and your computer.

Once connected, you may change the Fixed IP address on the **SETTINGS** page. For instance if you change the fixed IP address to 192.168.1.209, you would then need to type in 192.168.1.209/sigmaweb to access Sigma upon restarting.

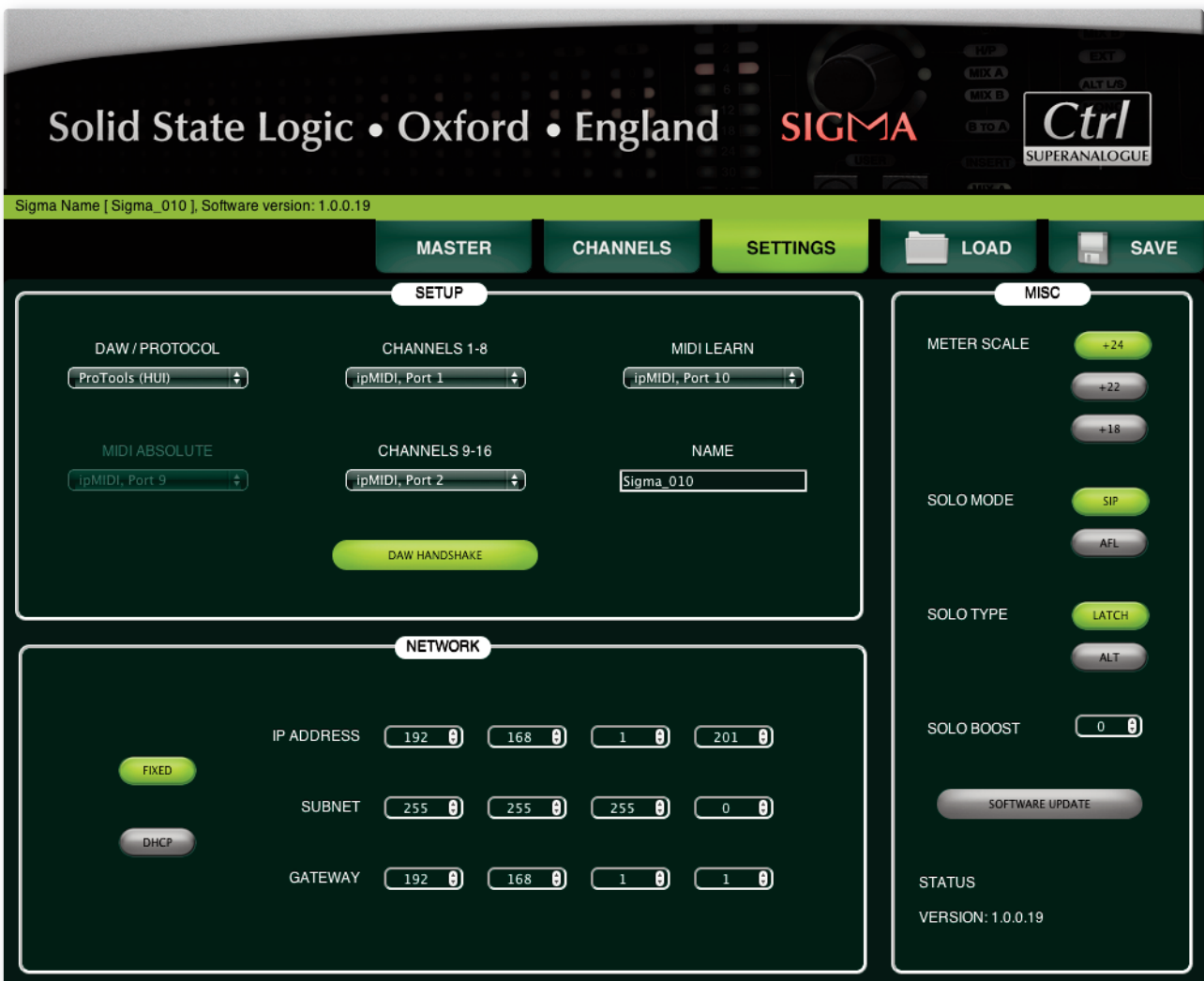

CONNECTING USING DHCP

In the **SETTINGS** page you can set Sigma to work by DHCP. After setting Sigma to DHCP and restarting the unit, use the following steps to connect to Sigma:

Macintosh Users (must use Safari)

1. Launch Safari
2. In Safari, go to Preferences > Bookmarks and click 'Include Bonjour' in the Bookmarks Bar.

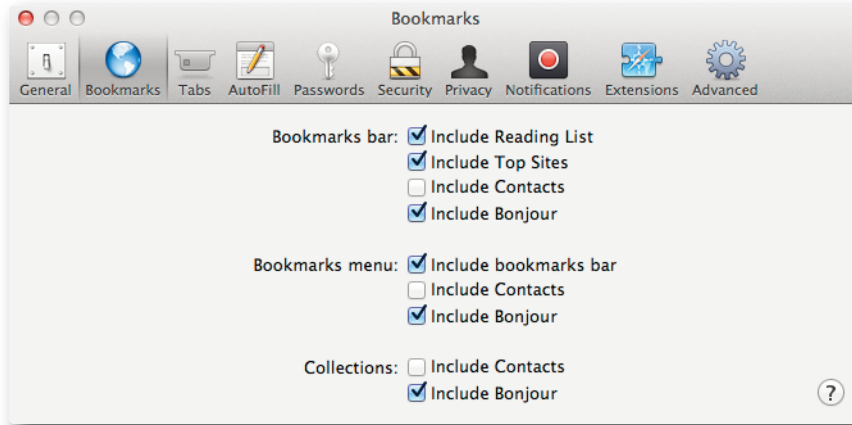

3. Bonjour should now appear in your bookmarks bar in Safari.
4. Select your SSL Sigma from the list and Safari will navigate to the Sigma pages.

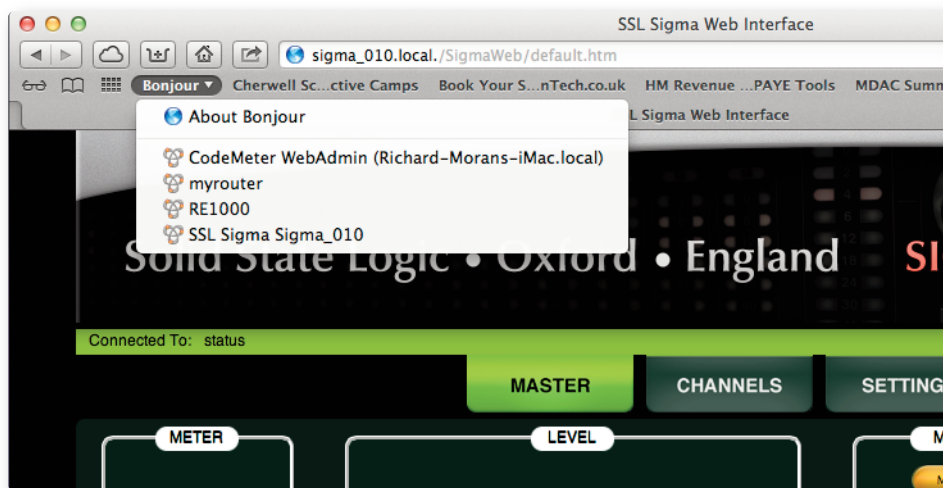

Windows Users

1. Go to your PC's Network settings

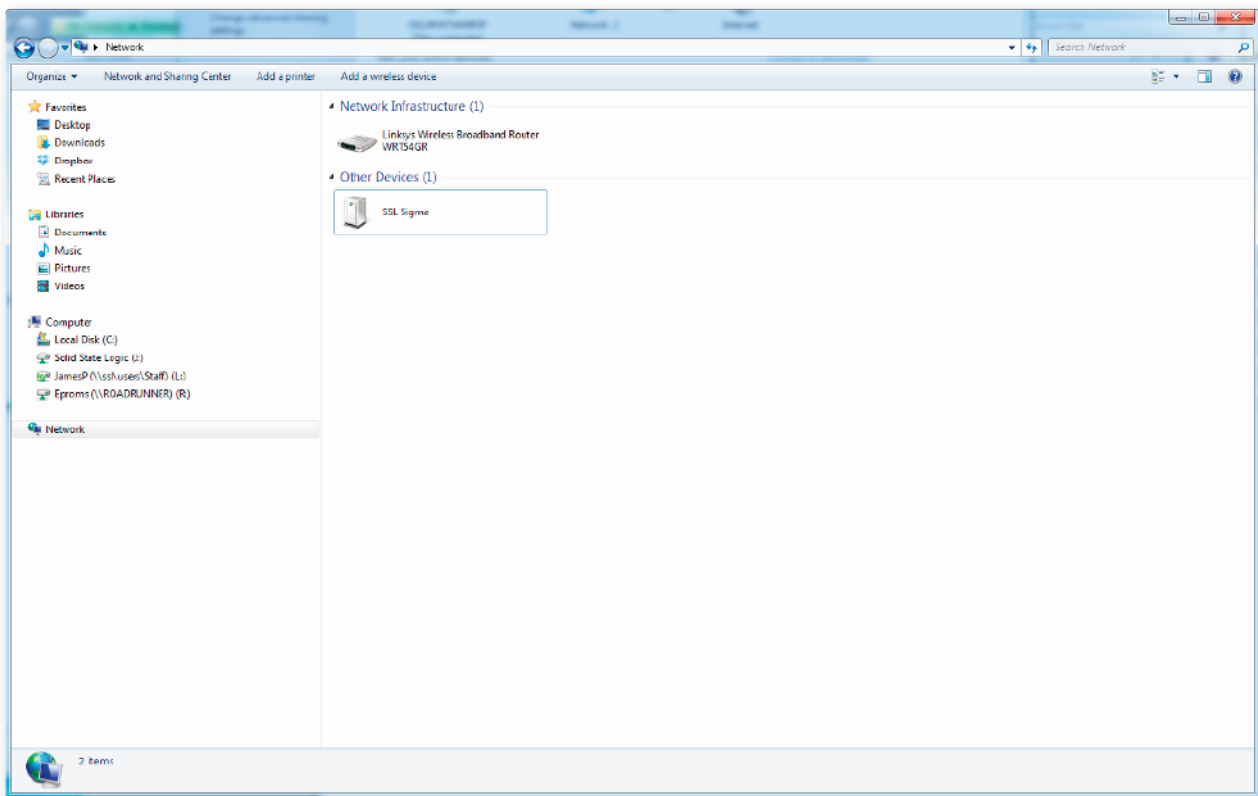

2. Sigma will be listed under "Other Devices". Double-click on the icon and it will load your web browser to the Sigma pages.

THE WEB BROWSER INTERFACE

Once connected, you have access to all of Sigma's functions using the web browser, which is arranged as follows:



MASTER

Upon connecting to Sigma, you will be looking at the **MASTER** page within the web browser. The state of most functions set within the browser, such as monitoring source or insert points in/out, are reflected on the physical Sigma front panel.

Master Meter

To the right of the 16 channel meters is the Master Meter. 'o' at the top indicates 0dBFS (+24dBu). This can be re-scaled globally with the 16 Channel meters in the **SETTINGS** page.

The web browser allows you to switch the master meter between the following:

- MON** Master Meter follows the current monitoring source(s).
- MIX A** Lock the Master Meter to follow the post-fader level of Mix Bus A
- MIX B** Locks the Master Meter to follow the post-fader level of Mix Bus B

Mix Bus Inserts

The Mix A and Mix B insert points are enabled through the browser by clicking on the **MIX A** and **MIX B** buttons inside the **INSERT** box. Inserts have a 'Σ' function which sums the insert return with the original main stereo mix bus signal. This may be useful for a several reasons: it will allow you to link the mix busses of two Sigmas together by connecting the mix bus output from the second Sigma into the insert return of the first Sigma; or you could use this function with one Sigma to create a parallel compression effect, using the compressor's output level to control the amount of compressed signal present.

Level Control

The front panel of Sigma has a blue rotary encoder, surrounded by an LED ring. Pushing the encoder in will cycle through the options **MON**, **H/P**, **MIX A** and **MIX B**, enabling independent level control of each one.

- MON** Main/Alternate monitor level
- H/P** Headphones output level
- MIX A** Mix Bus A level
- MIX B** Mix Bus B level

When setting the level of Mix A or Mix B, the dot that breaks up the LED ring will light red to indicate 0dB.

Push and hold the rotary encoder for two seconds, then release. The dimly lit LED ring now indicates that you are in **Fine** adjustment mode

- Coarse:** level steps in 0.5 dB
- Fine:** level steps in 0.1dB

Pushing and holding the rotary encoder again will return it to **Coarse** operation.

Note: The rotary encoder is speed-sensitive. Slower turns will allow you to change gains more accurately.

Web Browser

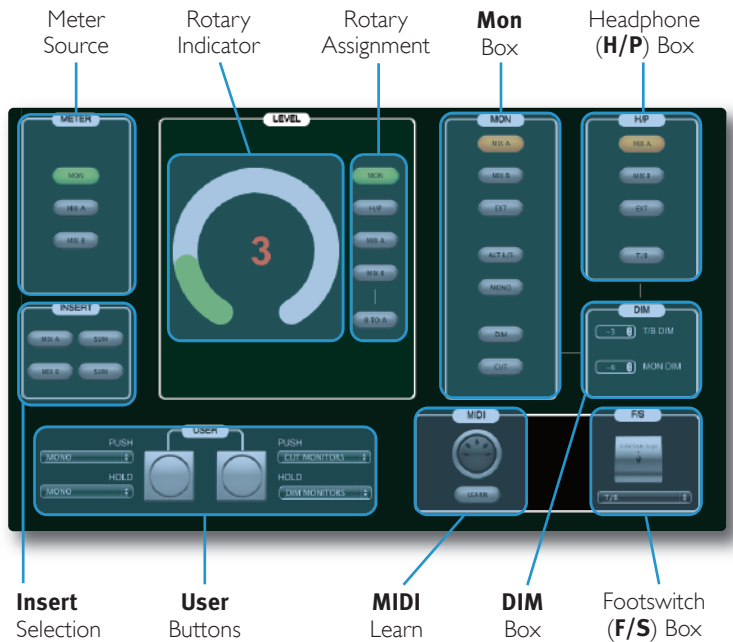

Unit Front Panel

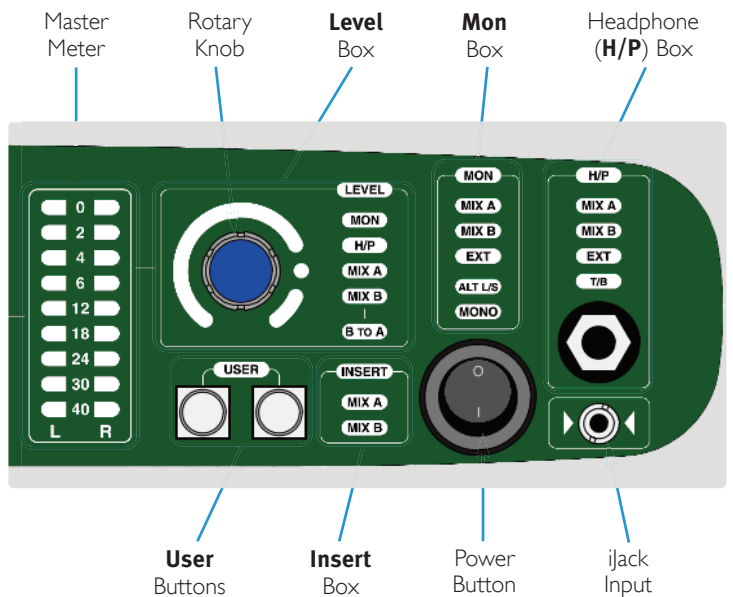

SOURCE	RANGE
MON	0 to 12
H/P	0 to 12
MIX A	-∞ to +10dB (red dot indicates 0dB)
MIX B	-∞ to +10dB (red dot indicates 0dB)

B TO A Function

The output of Mix Bus B can be injected into Mix A by engaging the **B TO A** button in the web browser. This would be useful for applying parallel compression to drums on Mix B (using the Mix B insert point) before blending the compressed drums into Mix A (containing the uncompressed instruments).

Mix B is injected post the Mix A insert point but pre Mix A level control. If you wish to inject the output of Mix B pre Mix A insert point, we suggest you take one of these two alternative approaches:

1. Take the Mix B output and connect it back into a stereo input of Sigma, being sure only to route it to Mix A to avoid an unwanted feedback loop.

E.g.: **MIX B OUTPUT > SIGMA STEREO CHANNEL > ROUTE TO MIX A > ENGAGE INSERT**

HINT: By bringing the output of Mix B into a channel input of Sigma, you are able to automate it like any other channel.

or:

2. Instead of using Mix A's insert point to connect your analogue processing equipment, simply connect the output of Mix A directly into any outboard equipment and take the output of this into your DAW to print back the mix. As a final step you can send the output of this stem out of your DAW into the EXT input of Sigma, to monitor your printed mix post D/A conversion.

ENGAGE B TO A FUNCTION > MIX A OUTPUT > ANALOGUE PROCESSING > DAW INPUT.

(Final Step) **DAW OUTPUT > EXT INPUT OF SIGMA > MONITOR EXT INPUT.**

USER Buttons

Two User buttons on the front panel allow you to assign up to four functions. Each button has a **Push** and a **Push & Hold** operation.

By default the User buttons are set as follows:

Left User Button

Push: Toggles Alternate loudspeaker selection on/off

Push & Hold: Toggles Mono check on/off

Right User Button

Push: Mutes loudspeaker outputs

Push & Hold: Dims loudspeaker outputs

The drop-down boxes in the web browser allow you to change these assignments.

MON Box

The **MON** box on the front panel indicates the control room monitor source(s) currently selected. This could be any combination of **MIX A**, **MIX B** or **EXT** (front panel iJack input and line-level connection on rear panel D-Sub).

ALT L/S indicates if you have selected the alternate speaker set and **MONO** shows if you are listening to a mono fold-down of the stereo mix.

All of these selections can be engaged/disengaged through the web browser.

*HINT: The **MON** LED on the front panel lights amber to indicate a monitor dim and lights red to indicate a monitor cut.*

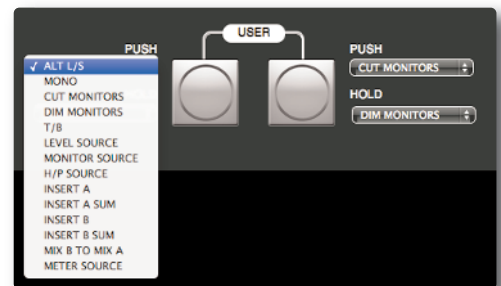

H/P Box

The **H/P** box on the front panel indicates which sources are feeding the headphones on both the front panel 1/4" jack output and the line-level output on the rear panel D-Sub connection. This may be any combination of **MIX A**, **MIX B** or **EXT**.

Sigma's talkback input can be switched on/off with the **T/B** button in the web browser. The talkback input is routed to both the front panel 1/4" headphone output and the rear panel line-level feed. Talkback is injected **post the H/P level control**, so you will need to use the output level of your talkback mic's preamp to control the overall talkback level.

Sigma does not include an internal talkback preamp. The T/B input is line-level input from which you should connect the output of the external preamp you are using with your talkback microphone.

The line-level headphones feed provided on the rear D-Sub provides a useful method of running the headphones feed into a separate live room/vocal booth. Typically, you would connect this into a cue mixer system, which the artist would plug their headphones into. The level of the headphone signal is controlled by selecting H/P in the Level Box and using the rotary encoder to adjust accordingly.

MIDI LEARN

Clicking the **LEARN** button beneath the MIDI icon activates Sigma's MIDI Learn mode. **LEARN** allows you to use CC messages (generated by a CC MIDI control surface) to control various functions on the **MASTER** page. This is useful if Sigma is installed into a remote rack outside your immediate reach.

Use the **SETTINGS** of the web browser to select an ipMIDI port for Sigma to receive MIDI CC messages through.

Follow the onscreen instructions to learn/un-learn functions.

Assignable MIDI Learn functions include:

- ROTARY LEVEL ENCODER
- LEVEL SOURCE CYCLE
- ALT L/S
- MONO
- CUT MONITORS
- DIM MONITORS
- T/B
- MONITOR SOURCE CYCLE
- H/P SOURCE CYCLE
- INSERT A
- INSERT A SUM
- INSERT B
- INSERT B SUM
- MIX B TO MIX A
- METER SOURCE CYCLE



FOOTSWITCH

On the rear panel of Sigma you will find a footswitch input, suitable for a 1/4" on/off (latching or non-latching) footswitch. SSL tested with a Digitech FS300 (non-latching) and a standard Marshall guitar footswitch (latching). By default, the footswitch is assigned to turn the talkback input on/off although this can be changed to any of the options available in the drop-down box.

DIM SETTINGS

T/B DIM (for Headphones) - When talkback is engaged, the **T/B DIM** level sets the amount of attenuation applied to the currently selected **MONITOR** source(s) in the headphones. A setting of 0dB will apply no attenuation and therefore simply sum the talkback input with the monitor sources. A setting of -∞ will apply maximum attenuation, completely muting the monitor source, leaving only the talkback input.

MON DIM (for control room) - Sets the level of DIM for the control room monitors, when the **DIM** button is engaged.

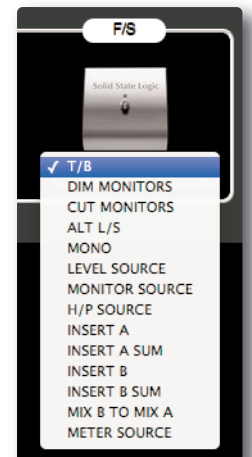

iJack Input

The bottom-right of Sigma's front panel provides a 1/8" stereo jack input for connecting consumer products such as iPods. This input can be sent to the control room monitors or headphones by selecting **EXT** (External Input).

If you wish to connect the output of a professional line-level source such as a CD player, there is a stereo external input available on the rear panel D-Sub connector. This will be summed with the front panel iJack input. See Appendix A for connection/pinout details.

CHANNELS



The **CHANNELS** page controls functions such as mix bus routing or mono/stereo selection for each channel. As with the **MASTER** page, many of these functions are reflected on the Sigma front panel.

Each channel on the Sigma front panel displays the input signal level (pre-fader) with a six segment LED display.

Sigma has 16 input channels that are individually switchable via the **MONO** button in the web browser. When operating in mono, a pan control will appear.

Just above the mix bus buttons, you'll see a value in dBs for each channel. This is the analogue "fader" gain readout for each channel and is useful for checking that the DAW's faders are controlling the analogue gains of Sigma.

Sigma has 2 mix busses: **A** and **B**. Each channel can be routed to either or both busses using the **MIX A** and **MIX B** buttons. Each channel can be renamed simply by clicking in and typing in the relevant box.

The **SOLO** button performs a solo-in-place, cutting all other channels. **CUT** mutes the channel's output.



Sigma Front Panel Channel

*The SOLO function can be changed from solo-in-place to an AFL style solo, using Mix Bus B as an AFL bus. Please see the **SETTINGS** section for more information.*

GLOBAL SETUP

The **GLOBAL SETUP** section at the bottom of the **CHANNELS** tab provides a number of useful quick functions.



NAMES

DAW This button will automatically rename the channels of Sigma to be the same as the first 16 names in your DAW session. This function will only work when using HUI/MCU (not MIDI).

CLEAR Clears all track names.

ALL

MONO Sets all channels of Sigma to mono.

STEREO Sets all channels of Sigma to stereo.

MIX A Assigns/de-assigns all channels to Mix Bus A.

MIX B Assigns/de-assigns all channels to Mix Bus B.

SOLO

SAFE This button enables you to protect channels in Sigma from cutting when a solo is made. For instance, you may not want your vocal reverb on channel 16 to be cut when soloing the dry vocal on channel 15. To configure a channel as 'solo safed' simply enable the **SAFE** button and then click (or touch if using a tablet) on a channel's **SOLO** button. This will show you a strikethrough line on the **SOLO** text to indicate it has been 'solo safed'. Clicking on the **SOLO** button a second time will disable it from being 'solo safed'. Exit this mode by clicking on the **SAFE** button once more.

CLEAR Clears any active solos on Sigma's channels.

SETTINGS



Unlike the **MASTER** and **CHANNELS** pages of Sigma, the **SETTINGS** page does not mirror any section of the front panel. This page contains many important setup aspects of Sigma.

SETUP Box

NAME

This box allows you to name your Sigma unit. This will be useful when using more than one Sigma.

DAW/PROTOCOL SELECTION

This must be set in order to allow Sigma to correctly translate automation data from the DAW. There are five options:

- **Pro Tools (HUI)**
- **Logic (MCU)**
- **Cubase/Nuendo (MCU)**
- **Ableton (MCU)**
- **MIDI**

See Chapter 6 ‘*Example Setups*’ for more information on which one to choose for your setup.

ipMIDI Ports

CHANNELS 1-8

Select the ipMIDI Port number to match your first HUI/MCU unit in your DAW.

CHANNELS 9-16

Select the ipMIDI Port number to match your second HUI/MCU unit in your DAW.

MIDI ABSOLUTE

The **MIDI ABSOLUTE** box will become available if **MIDI** is selected in the **DAW/PROTOCOL** drop-down list. **MIDI ABSOLUTE** offers an alternative way of controlling Sigma's analogue gains directly from the DAW. Instead of sending volume messages over the HUI/MCU protocol, **MIDI ABSOLUTE** works by sending MIDI volume messages directly from the outputs of MIDI tracks within the DAW. Set the MIDI Absolute ipMIDI port to be the same as the ipMIDI port that your 16 MIDI Track outputs are set to in the DAW.

See Chapter 6 'Example Setups' for more information.

*Note the **CHANNELS 1-8** and **CHANNELS 9-16** drop-down boxes have no effect when MIDI is being used.*

DAW HANDSHAKE

Some DAWs perform 'handshaking' with HUI/MCU devices. Pro Tools sends out frequent handshake messages, whereas Logic only performs a handshake upon first connection or changing sessions. The **EXAMPLE SETUPS** section offers advice on when to have **DAW HANDSHAKE** enabled and when to have it disabled.

If you have two HUI devices (such as a Nucleus and Sigma) connected on your network, then only one of them needs to perform the 'handshaking'. If both are 'handshaking' this may cause problems.

In general:

Leave **HANDSHAKE** enabled (button lights green), if there are no other HUI devices on your network apart from Sigma.

DISABLE HANDSHAKE Leave **HANDSHAKE** enabled (button lights green), if there are no other HUI devices on your network apart from Sigma.

MIDI LEARN

Many functions on the **MASTER** page of Sigma can be enabled/disabled from an external MIDI controller sending CC messages (e.g. the CC layer available on an SSL Nucleus). You should set this drop-down to match the ipMIDI port number from which the MIDI CC messages are being sent on. For instance, if Nucleus' CC layer is setup on DAW Layer 3, this drop-down should be set to **ipMIDI Port 5**.

The **MIDI LEARN** drop down box only allows access to ipMIDI ports. If you wish to use a MIDI device/interface that does not use ipMIDI, you can download a free program called 'MIDI Patchbay' to route the output of your chosen MIDI device into an ipMIDI port.

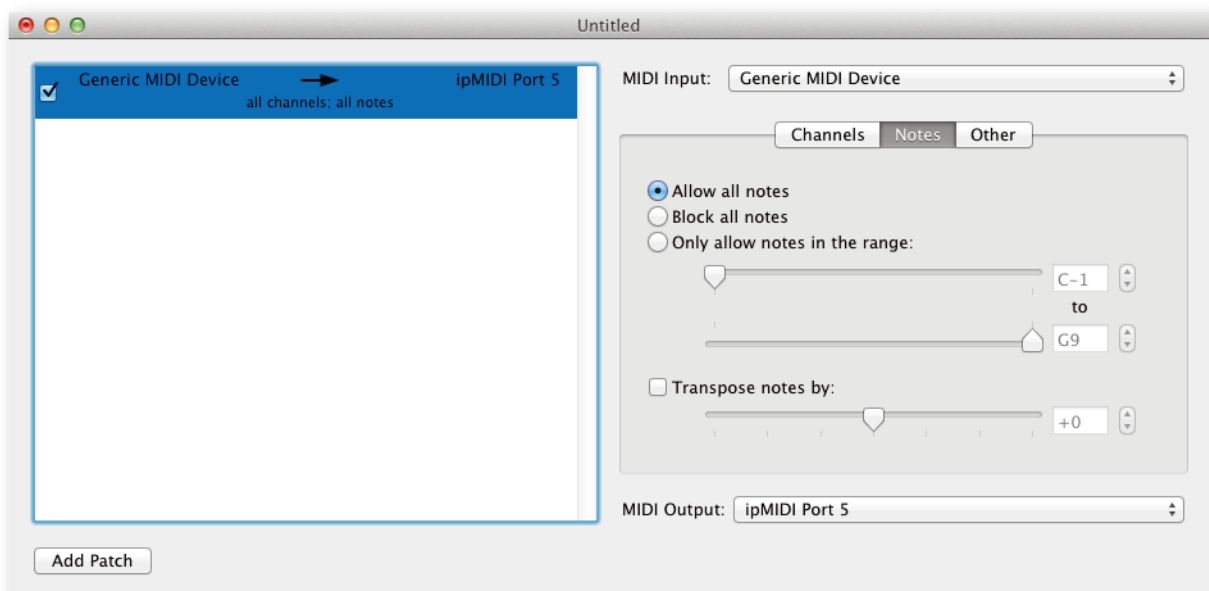

NETWORK Box

You are able to choose between a **FIXED IP** address or **DHCP** configuration. The static IP address of Sigma defaults to 192.168.1.201. Please see **NETWORK SETUP** section for more information.

MISC Box

This section contains a number of miscellaneous settings.

METER SCALE

Meter scaling is applied globally to all channel meters and the master meter. Set to match the odBFS reference of your A/D D/A converter. The three options are: +24dBu, +22dBu or + 18dBu. By default, Sigma is set to +24dBu = odBFS.

SOLO MODE

This controls how the **SOLO** function works in the **CHANNELS** page. If you are unfamiliar with different solo modes then the following explains the differences between the two:

SIP (Solo-In-Place) Soloing a channel causes all other channels to be muted.

AFL (After Fader Level) Soloing a channel moves that signal onto a separate stereo mix bus, normally known as the AFL bus.

Sigma does not have a dedicated AFL bus. However, selecting the **AFL** option in **SOLO MODE** will hijack Mix Bus B and use this as an AFL bus. Sigma will automatically switch the monitor source selection to Mix Bus B when soloing in this mode.

AFL is useful when you want to solo a channel just to check something whilst printing a mix back into the DAW. If you were to use SIP, you would disrupt the printing process as soloing in this mode mutes all other channels.

Please note that if you are operating Sigma in AFL Solo Mode, you will be unable to route channels to Mix Bus B in the web browser. Also, upon changing to AFL Solo Mode, any channels currently routed to Mix Bus B will be unrouted.

By default, Sigma is set to **SIP (Solo-In-Place)**.

SOLO TYPE

LATCH When one channel is in solo, pressing a second **SOLO** button adds this channel to the first rather than cancelling the original channel.

ALT When **ALT** is selected the **SOLO** buttons are prevented from latching, introducing inter-cancellation between **SOLO** buttons: pressing a second **SOLO** button cancels the first **SOLO**.

By default, Sigma is set to **LATCH**.

SOLO BOOST

SOLO BOOST automatically increases the monitor level by the set amount when a **SOLO** is activated (range 0 - 10dB). This is useful when mixing to help reduce the level difference apparent when changing from listening to the whole mix to just one soloed channel.

SOFTWARE UPDATE

The **SOFTWARE UPDATE** button is used to update Sigma's internal software. You must have the ethernet cable connected to perform the update. Below the button you will see the current version of Sigma software you are running. There may be infrequent updates provided for Sigma. The .bin file used to update Sigma's software will be available from the SSL website. Go to the Sigma product page and go to the **Downloads** tab to login and download.

After downloading the .bin file, Click on the **SOFTWARE UPDATE** button in the **SETTINGS** page of the web browser and locate the downloaded .bin file. Follow the onscreen instructions.

IMPORTANT - After updating your Sigma software and restarting, you will need to clear your web browser's Cache in order for all changes to take effect. You may also need to Refresh the page.



REBOOT Button

When you make a change in the **SETTINGS** page that requires Sigma to be restarted in order for the change to have effect, a message will prompt you to perform a restart. The **SOFTWARE UPDATE** button will temporarily change to a **REBOOT** button. Click this to restart Sigma.

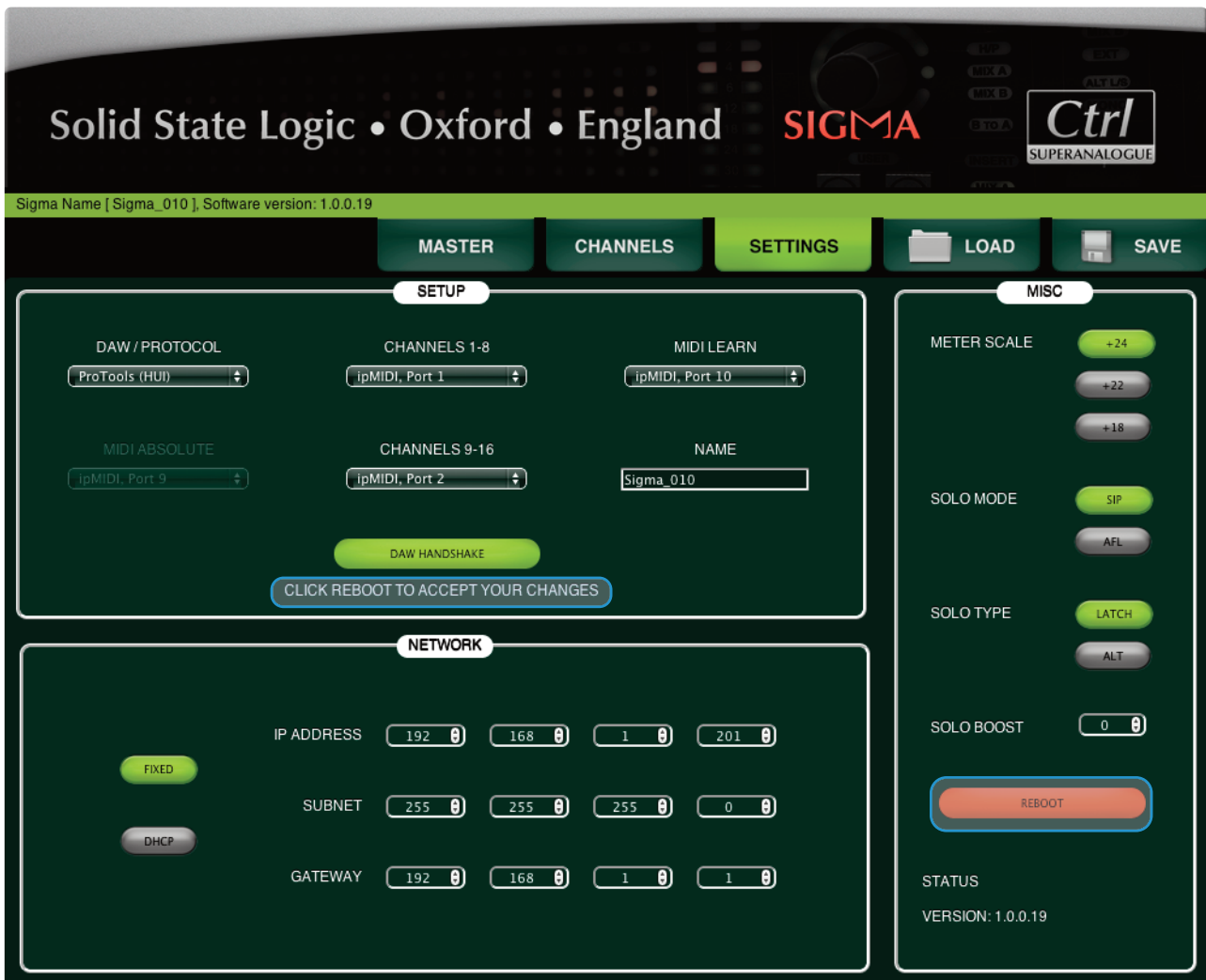

SAVE AND LOAD BUTTONS

The **SAVE** button will save all of Sigma's settings across the three main pages - **MAIN**, **CHANNELS** and **SETTINGS**.

Upon clicking the **SAVE** button you will be presented with a pop-up asking you to name the file and choose a destination on your computer/network.

The **LOAD** button enables you to recall a previously saved Sigma setup.

Upon clicking the **LOAD** button you will be prompted to locate a saved Sigma file from your computer/network.

Sigma files are saved as .xml type files.



6. Example Setups

This section will provide a guide for how to configure Sigma in various setups. This section presumes you have established a network connection to Sigma and installed the ipMIDI software. Please see the relevant sections if you have not already done this.

PRO TOOLS + SIGMA (NO CONTROL SURFACE)

In this example we will configure Sigma to work with Pro Tools on ipMIDI channels 1 and 2.

Sigma Browser Settings

1. Go to the **SETTINGS** page in the Sigma browser.
2. Set **DAW/PROTOCOL** to **PRO TOOLS (HUI)** from the drop-down box.
3. Set **CHANNELS 1-8** to **ipMIDI Port 1** and set **CHANNELS 9-16** to **ipMIDI Port 2**.
4. Enable the **DAW HANDSHAKE** button (lights green).



Pro Tools Settings

1. Open Pro Tools.
2. Go to **Setup > Peripherals...** and then go to the **MIDI Controllers** tab.
3. Set the first row to type **HUI**, with **Receive From** and **Set To** both set to **ipMIDI Port 1**.
4. Set the second row to type **HUI**, with **ipMIDI Port 2**.
5. Click **OK** to confirm.

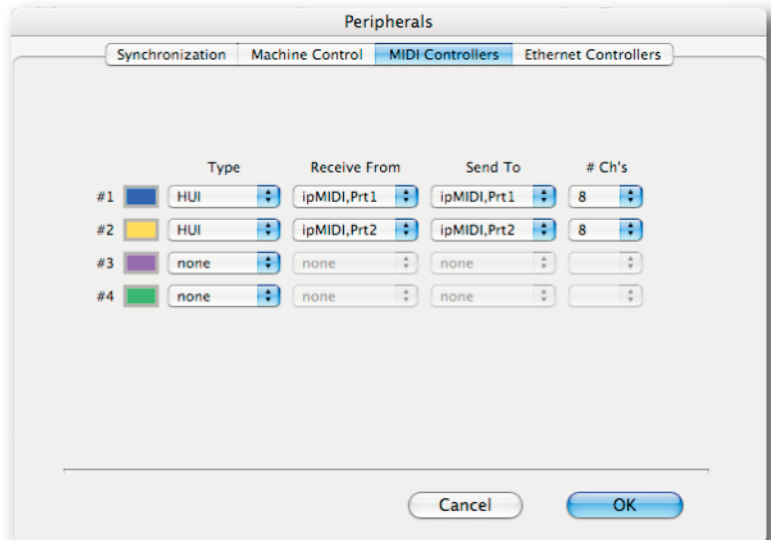

Pro Tools Session Setup

The final step is to create 16 new tracks which will be our dedicated fader controls for each of Sigma's analogue channels.

1. Go to **Track > New...**
2. Create 16 new blank Audio Tracks (it does not matter if they are mono or stereo).
3. Make sure that these 16 audio tracks are positioned as the first 16 tracks of the session.

Any volume automation data or fader movements on these 16 tracks will control the analogue signal gains of Sigma.

4. Your existing tracks with audio recorded to them should be routed out of different outputs on your audio interface, which will then feed the appropriate Sigma inputs channels (just like you would do with any normal summing unit).

16 tracks positioned at top of the session to control Sigma's 16 analogue gains



Notes:

These 16 audio tracks must be positioned as the first 16 in the session, as the HUI/MCU protocols dictate this. Pan information is not read, you must set the pan in the **CHANNELS** page of Sigma browser.

Tip: You probably want to rename these Audio Tracks to meaningful names such as 'KICK' instead of Audio1. Once you have done this in the DAW, go to the **CHANNELS** page in the web browser and click the **DAW > NAMES** button in the global menu. This will copy across the names of the 16 tracks.

PRO TOOLS + SIGMA + NUCLEUS (OR ANY STANDARD HUI CONTROL SURFACE)

In this example we will configure Sigma to work together with a Nucleus. You could follow the setup procedure for Pro Tools + Sigma (no control surface) however, when using a HUI controller, banking through channels will mis-align the automation data. e.g. if you use the 'Channel Right' button a Nucleus to make the second track in the session appear on Channel 1 of Nucleus, your automation stream from the second track in your DAW will drive the first analogue channel of Sigma - not what we want!

To solve this problem, we have provided a **MIDI** automation mode, as found in our Matrix console. This mode works by using MIDI tracks in your session to control the analogue gains directly, rather than over the HUI/MCU protocols. Therefore, banking does not have any unwanted effects on the automation data.

Sigma Browser Settings

1. Go to the **SETTINGS** page in the Sigma browser.
2. Set **DAW/PROTOCOL** to **MIDI** from the drop-down box.
3. Disable the **HANDSHAKING** button.
4. Go to the **MIDI ABSOLUTE** mode and pick an **ipMIDI Port** - e.g. **Port 9**.

*Note that the **CHANNELS 1-8** and **CHANNELS 9-16** boxes have no effect when using MIDI.*

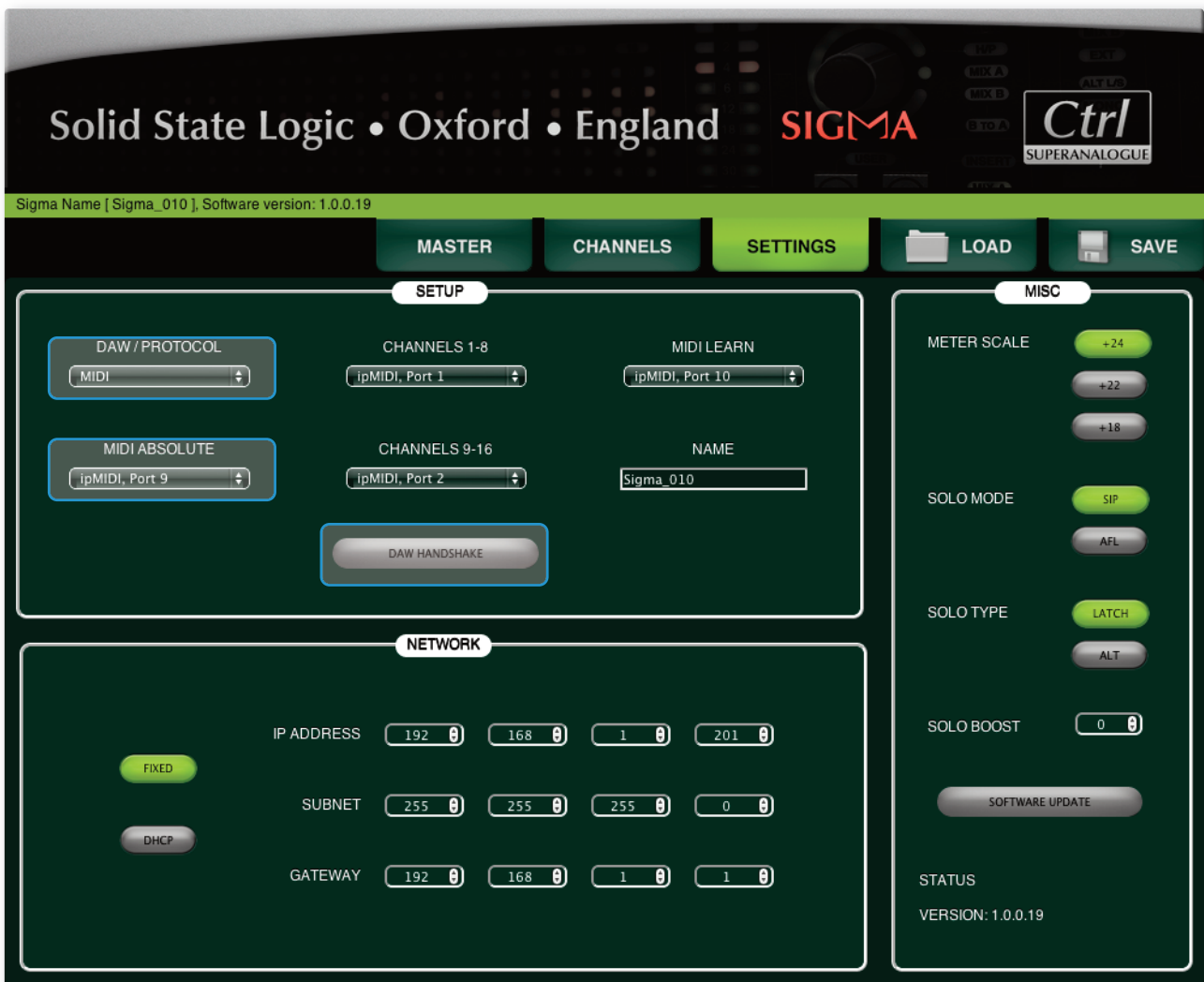

Pro Tools Settings

1. Open Pro Tools.
2. Have the **Setup > Peripherals... > MIDI Controllers** configured as you would normally for your Nucleus (or HUI) controller e.g. The screenshot shows a Nucleus setup for use on DAW Layer 1. Note that with this setup, this is not how the analogue gains of Sigma are driven. That will be done over the MIDI tracks in the following steps...

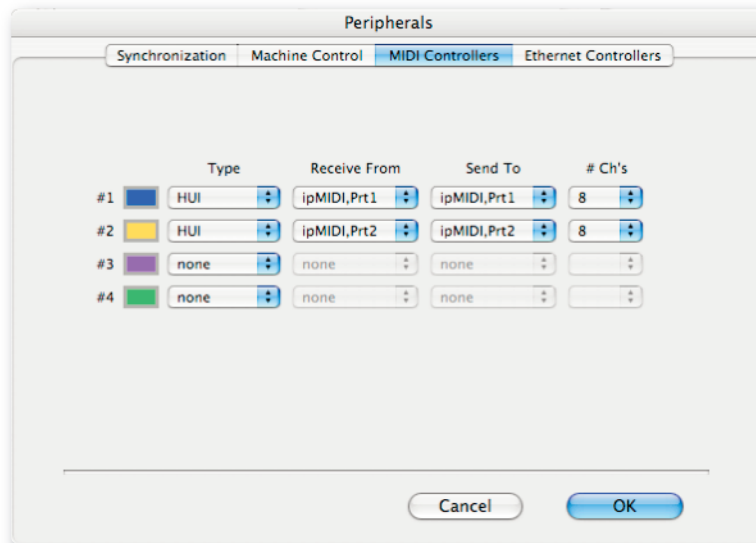

Pro Tools Session Setup

1. Go to **Track > New...**
2. Create 16 new **MIDI Tracks** (it does not matter where they are positioned in the session).
3. Leave the inputs to the MIDI Tracks set to **ALL**.
4. Set the output of the first MIDI track to **ipMIDI Port 9, channel-1**.
5. Continue setting the outputs in this way incrementally to get all 16 channels e.g. The second MIDI track is set to output on **ipMIDI Port 9, channel-2**, the third MIDI track is set to output on **ipMIDI Port 9, channel-3**, etc.

Any volume automation data or fader movements on these 16 MIDI tracks will control the analogue gains of Sigma.

6. Your existing tracks with audio recorded to them should be routed out of different outputs on your audio interface, which will then feed the appropriate Sigma inputs channels (just like you would do with any normal summing unit).

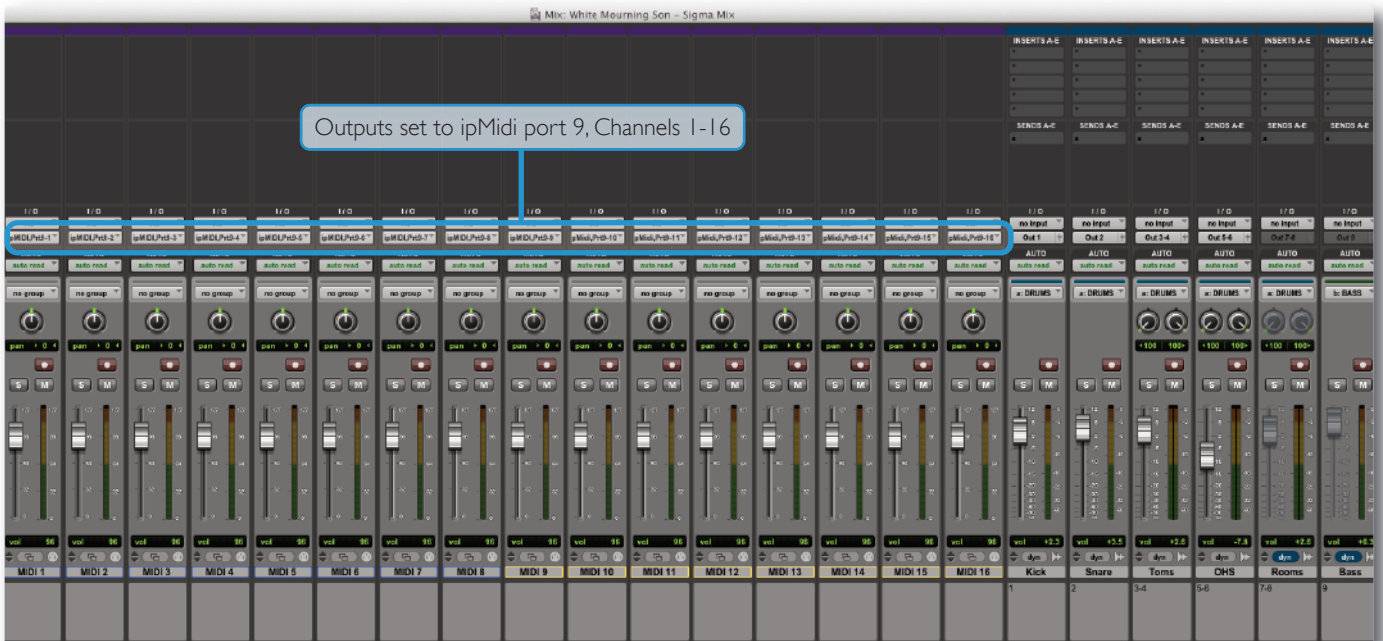

7. You will need to move the MIDI faders before their levels are picked up by Sigma.
8. We recommend you use Pro Tools' **Solo Safe** feature to Solo Safe the 16 MIDI tracks. This will ensure that when you solo one of your audio tracks in Pro Tools, the automation data will still be read.

*Tip: When using **MIDI Absolute**, the volume information is being sent discreetly from the output of each MIDI track. This means that you can position these MIDI tracks anywhere in your DAW session. They do not have to be arranged as the first 16 tracks.*

Notes:

Although MIDI faders have a maximum resolution 127 values, these values are scaled in such a way to provide smooth and natural volume automation in the useful range of fader travel.

*Pan information is not read, you must set the pan in the **CHANNELS** page of Sigma browser.*

PRO TOOLS + SIGMA + AVID® ARTIST SERIES CONTROL SURFACE (EUCON)

In this example we will configure Sigma to work together with a Artist Series Control Surface such as the **Artist Control®**. The HUI and Eucon protocols are able to work simultaneously. When using a Eucon control surface, banking is done in the Eucon domain and does not affect automation streams on Sigma.

In this example we will configure Sigma to work with Pro Tools on ipMIDI channels 1 and 2.

Sigma Browser Settings

1. Go to the **SETTINGS** page in the Sigma browser.
2. Set **DAW/PROTOCOL** to **PRO TOOLS (HUI)** from the drop-down box.
3. Set **CHANNELS 1-8** to **ipMIDI Port 1** and set **CHANNELS 9-16** to **ipMIDI Port 2**.
4. Enable the **HANDSHAKING** button.

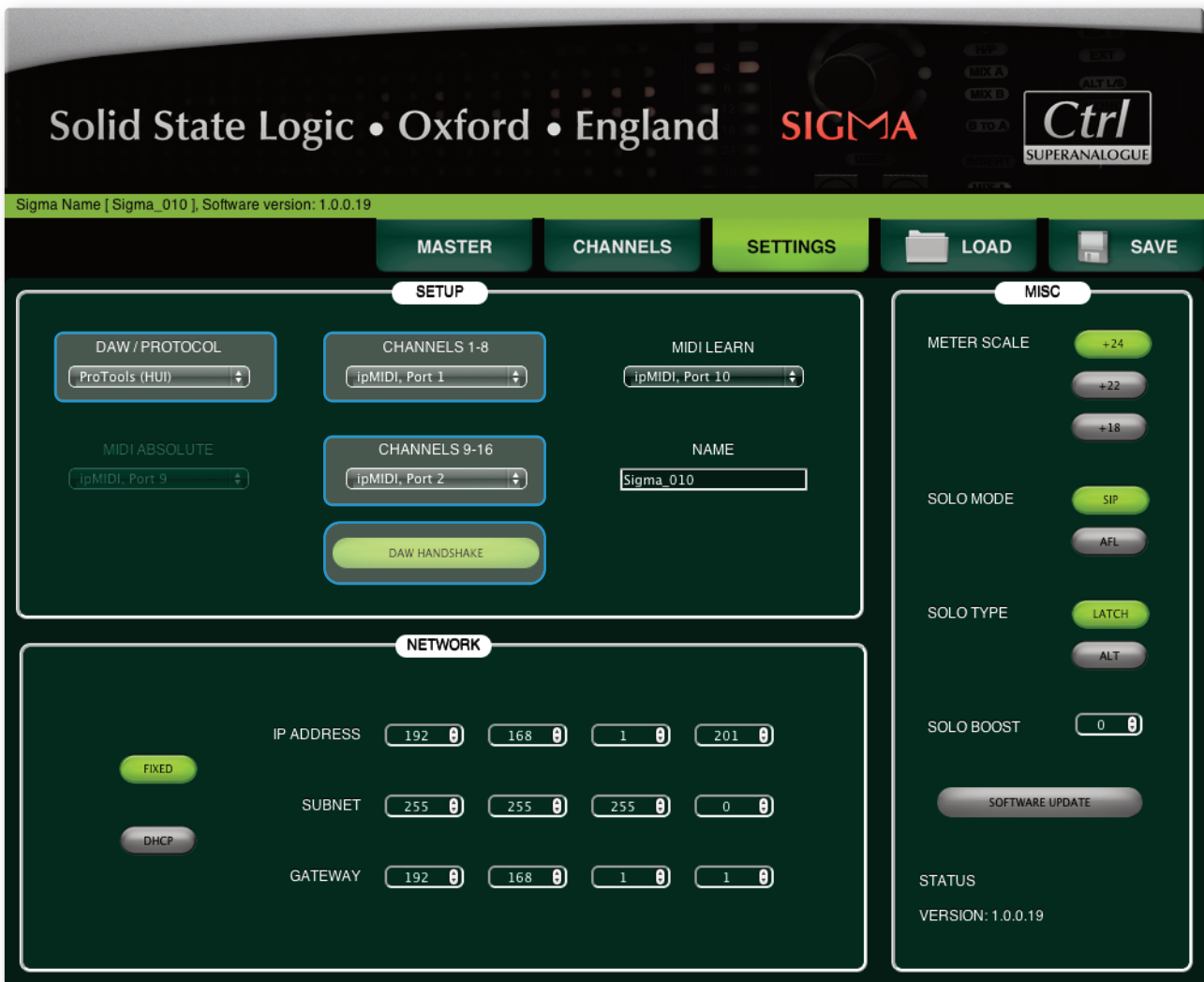

Pro Tools Settings

1. Open Pro Tools.
2. Go to **Setup > Peripherals... > MIDI Controllers**.
3. Set the first row to type **HUI**, with **Receive From** and **Send To** both set to **ipMIDI Port 1**.
4. Set the second row to type **HUI**, with **ipMIDI Port 2**.
5. Click **OK** to confirm.

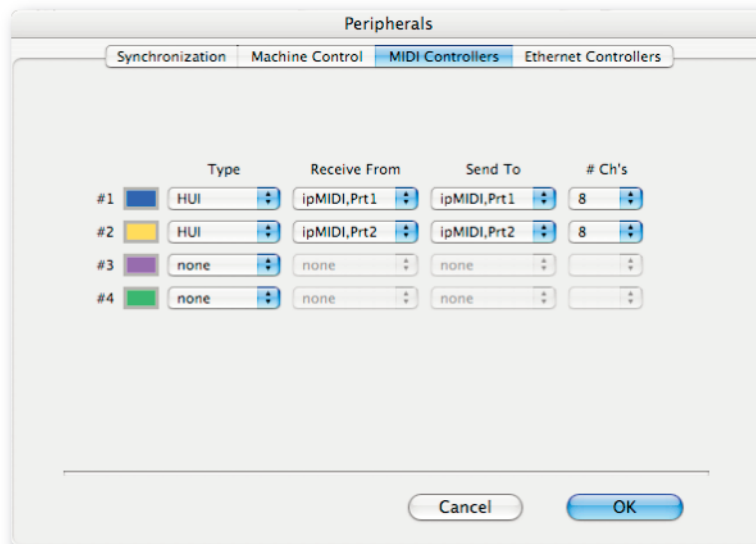

Artist Controller Settings

Leave your Eucon settings the same in the **Ethernet Controllers** tab.

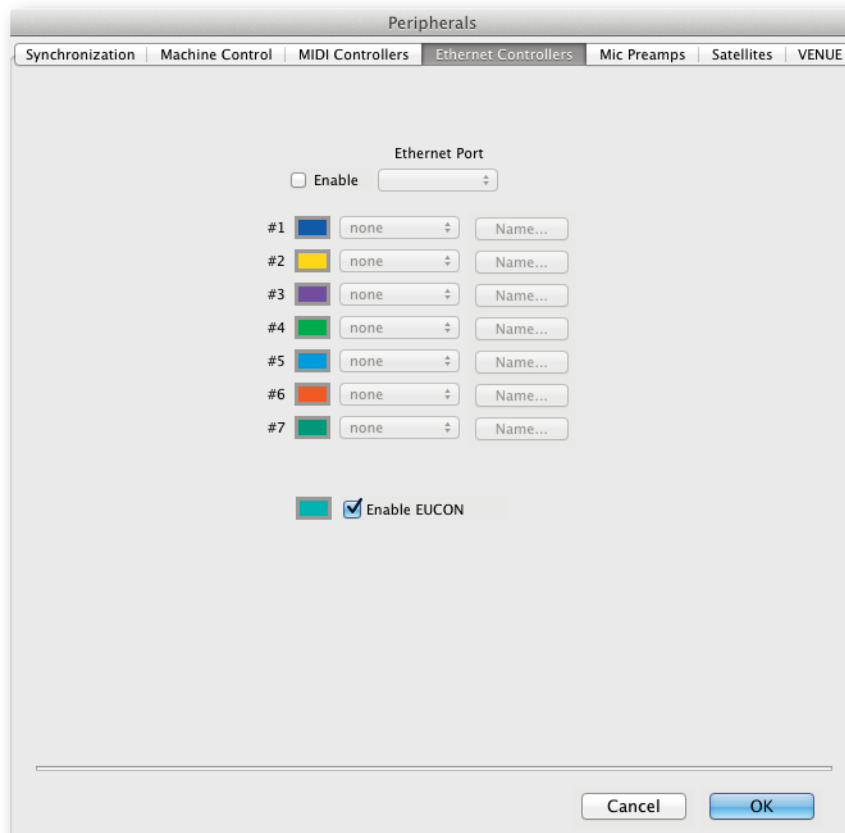

Pro Tools Session Setup

1. Go to **Track > New...**
2. Create 16 new blank **Audio Tracks** (it does not matter if they are mono or stereo)
3. Make sure that these 16 audio tracks are positioned as the first 16 tracks of the session

Any volume automation data or fader movements on these 16 tracks will control the analogue gain changes of Sigma.

4. Your existing tracks with audio recorded to them should be routed out of different outputs on your audio interface, which will then feed the appropriate Sigma inputs channels (just like you would do with any normal summing unit).

Control tracks must be Tracks 1-16 in the session.



Notes:

These 16 audio tracks must be positioned as the first 16 in the session, as the HUI/MCU protocols dictate this. Pan information is not read, you must set the pan in the **CHANNELS** page of Sigma browser.

Tip: You probably want to rename these Audio Tracks to meaningful names such as 'KICK' instead of Audio1. Once you have done this in the DAW, go to the **CHANNELS** page in the web browser and click the **DAW > NAMES** button in the global menu. This will copy across the names of the 16 tracks.

LOGIC + SIGMA (NO CONTROL SURFACE)

In this example we will configure Sigma to work with Logic on ipMIDI channels 1 and 2.

Sigma Browser Settings

1. Go to the **SETTINGS** page in the Sigma browser.
2. Set **DAW/PROTOCOL** to **LOGIC (MCU)** from the drop-down box.
3. Set **CHANNELS 1-8** to **ipMIDI Port 1** and set **CHANNELS 9-16** to **ipMIDI Port 2**.
4. Enable the **DAW HANDSHAKE** button (lights green).



Logic Settings

1. Open Logic.
2. Go to **Preferences > Control Surfaces Setup...**
3. Choose **New** and then **Install...**
4. Select a **Mackie Designs - Mackie Control** and click **Add**.
5. Set the **Output Port** and **Input Port** to **Port 1**.
6. Now select a **Mackie Designs - Mackie Control Extender** from the list and click **Add**.
7. Set the **Output Port** and **Input Port** to **Port 2**.

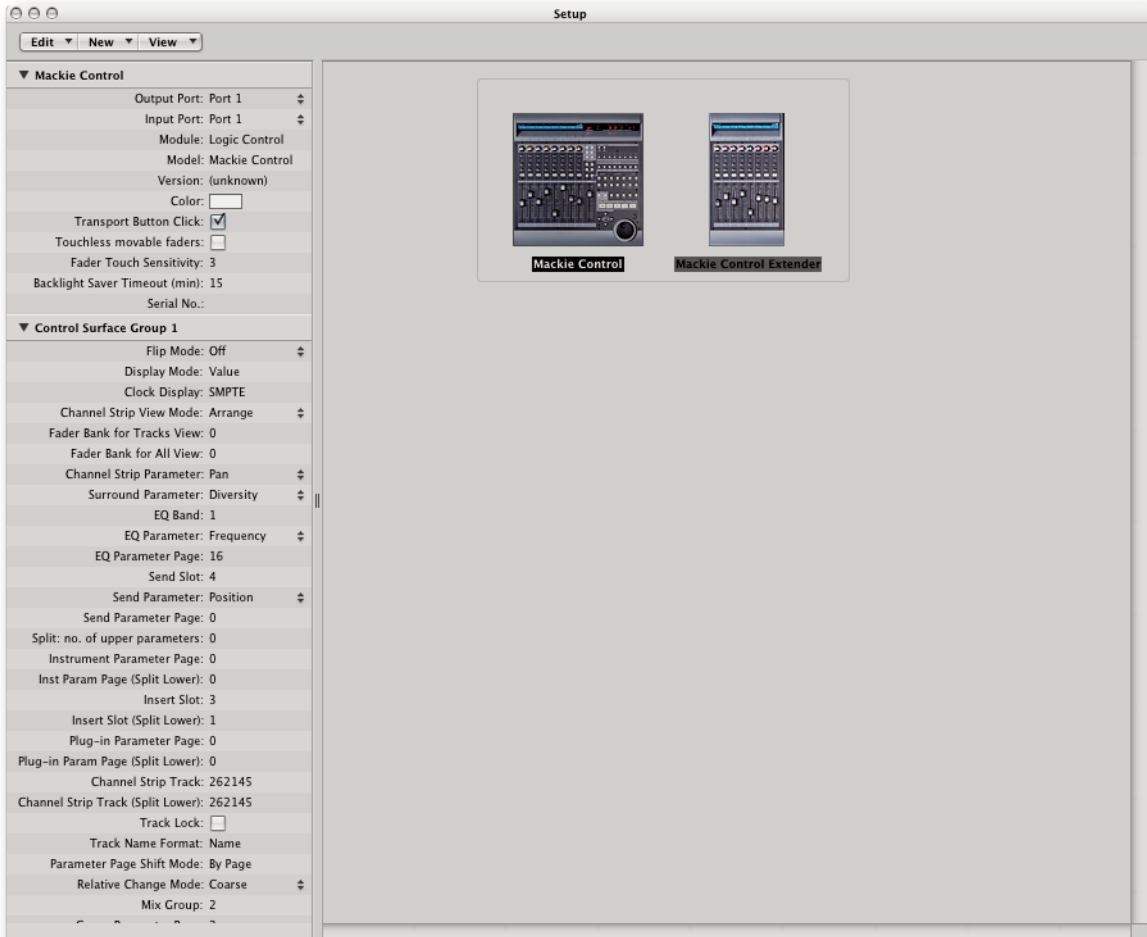

*Important: Please ensure you are selecting the **Mackie Designs - Mackie Control Surface** and **NOT** the **Mackie Designs - Logic Control Surface**. The Logic Control Surface sends different messages and Sigma will not respond to these.*

Logic Session Setup

The final step is to create 16 new tracks which will be our dedicated fader controls for each of Sigma's analogue channels.

1. Use the + button and to create **16 new Audio Tracks** (it does not matter if they are mono or stereo)
2. Make sure that these 16 audio tracks are positioned as the first 16 tracks of the session
Any volume automation data or fader movements on these 16 tracks will control the analogue gain changes of Sigma.
3. Your existing tracks with audio recorded to them should be routed out of different outputs on your audio interface, which will then feed the appropriate Sigma inputs channels (just like you would do with any normal summing unit).

Control tracks must be Tracks 1-16 in the session.



4. It is recommended to set the Logic Mixer to **'Arrange'** view mode. This will ensure that the first 16 'control tracks' always correspond to Sigma's 16 analogue gains. If using Instruments tracks with Multi Outputs, also ensure that the **'Link'** button is **disabled**, to prevent Logic automatically switching back to the **'All'** view mode when you click on an instrument.



Notes:

These 16 audio tracks must be positioned as the first 16 in the session, as the HUI/MCU protocols dictate this. Pan information is not read, you must set the pan in the **CHANNELS** page of Sigma browser.

Tip: You probably want to rename these Audio Tracks to meaningful names such as 'KICK' instead of Audio1. Once you have done this in the DAW, go to the **CHANNELS** page in the web browser and click the **DAW > NAMES** button in the global menu. This will copy across the names of the 16 tracks.

LOGIC + SIGMA + NUCLEUS (OR ANY STANDARD MCU CONTROL SURFACE)

In this example we will configure Sigma to work together with a Nucleus. Logic uses 'Control Surface Groups' so that the actions of one controller does not affect another. This is useful for us, as setting up 'Control Surface Groups' allows the banking commands of a control surface to remain separate from the automation streams controlling Sigma. Using this method, when you press **bank** on your control surface, the automation streams into Sigma do not follow the banking command.

Sigma Browser Settings

We'll set up Sigma on ipMIDI channels 1 & 2.

1. Go to the **SETTINGS** page in the Sigma browser.
2. Set **DAW/PROTOCOL** to **LOGIC (MCU)** from the drop-down box.
3. Set **CHANNELS 1-8** to **ipMIDI Port 1** and set **CHANNELS 9-16** to **ipMIDI Port 2**.
4. Disable **DAW HANDSHAKE** (goes grey).

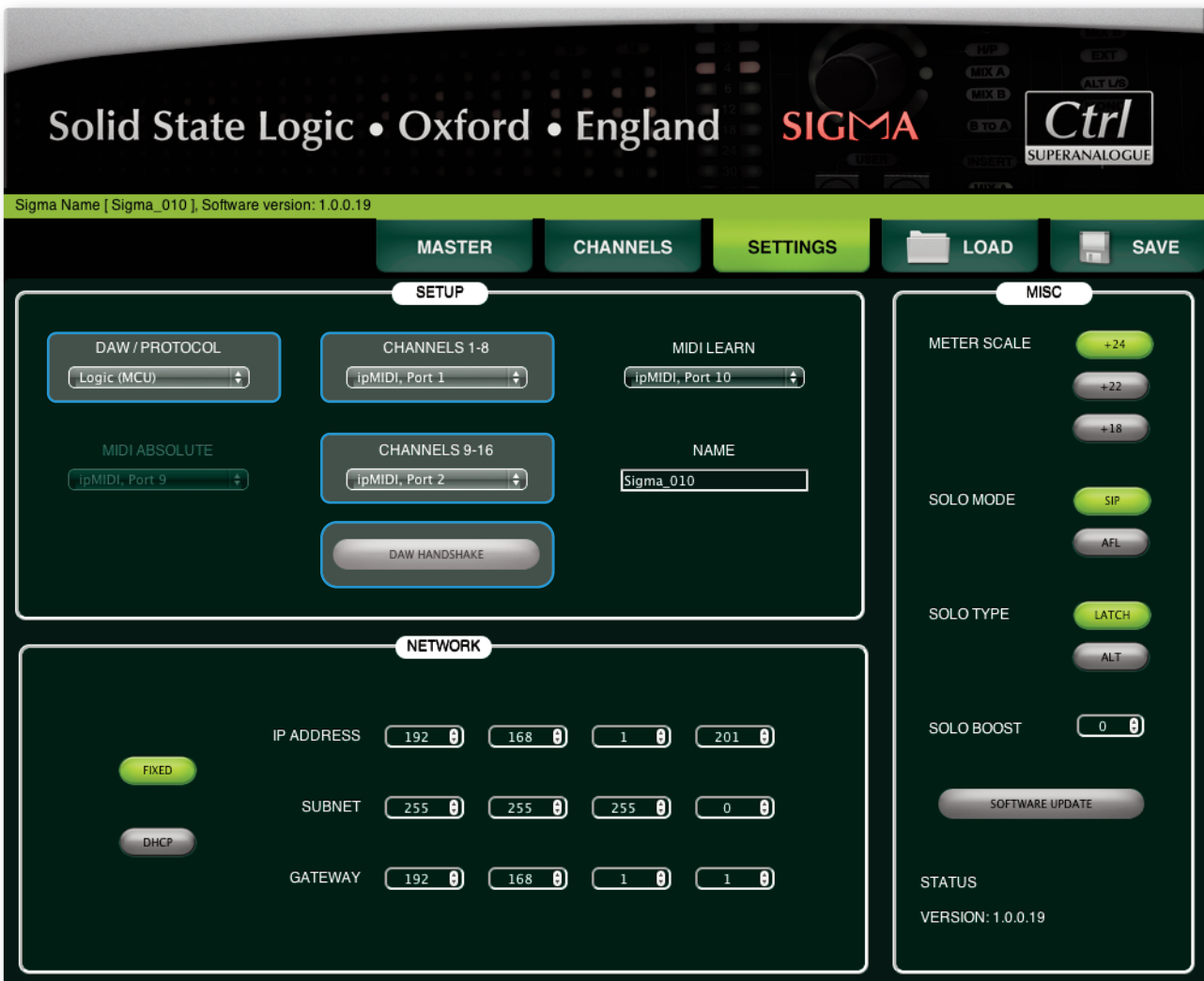

Logic Control Surface Settings

First, we'll set up Sigma.

1. Open Logic.
2. Go **Preferences > Control Surfaces Setup...**
3. Choose **New** and then **Install...**
4. Select a **Mackie Designs - Mackie Control** and click **Add**.
5. Set **Output Port** and **Input Port** to **Port 1**.
6. Now select a **Mackie Designs - Mackie Control Extender** from the list and click **Add**.
7. Set **Output Port** and **Input Port** to **Port 2**.

*Important: Please ensure you are selecting the **Mackie Designs - Mackie Control Surface** and **NOT** the **Mackie Designs - Logic Control Surface**. The Logic Control Surface sends different messages and Sigma will not respond to these.*

Now, we'll set up Nucleus for operation on DAW Layer 2:

3. Choose **New** and then **Install...**
4. Select a **Mackie Designs - Mackie Control** and click **Add**.
5. Set **Output Port** and **Input Port** to **Port 3**.
6. Select a **Mackie Designs - Mackie Control Extender** and click **Add**.
7. Set **Output Port** and **Input Port** to **Port 4**.
8. This is the important part: When you have all the Mackie Controllers and Extenders in a line, highlight the last two (Mackie Control #2 and Mackie Control Extender #2) and **drag them underneath the first two controllers**. Doing this will create a different 'Control Surface Group'.

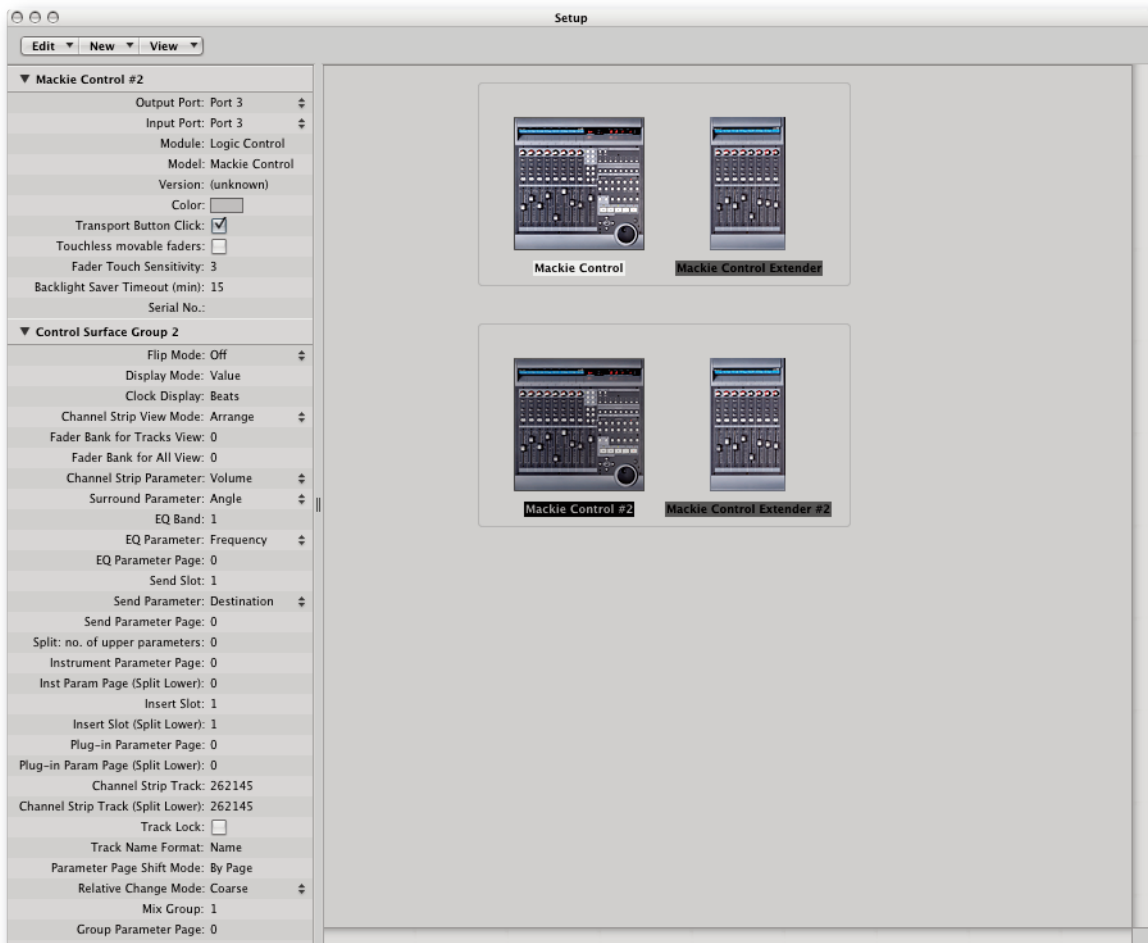

Logic Control Surface Preferences

You now need to ensure that Logic's Control Surfaces Preferences are set correctly. Go to **Preferences > Control Surfaces** and set the options to match the screenshot to the right. Ensure that the option **'Control surface follows track selection'** is un-ticked.

Logic Session Setup

The final step is to create 16 new tracks which will be our dedicated fader controls for each Sigma analogue channel.

1. Use the + button and to create **16 new Audio Tracks** (it does not matter if they are mono or stereo)
2. Make sure that these 16 audio tracks are positioned as the first 16 tracks of the session

Any volume automation data or fader movements on these 16 tracks will control the analogue signal gains of Sigma.

3. Your existing tracks with audio recorded to them should be routed out of different outputs on your audio interface, which will then feed the appropriate Sigma inputs channels (just like you would do with any normal summing unit).

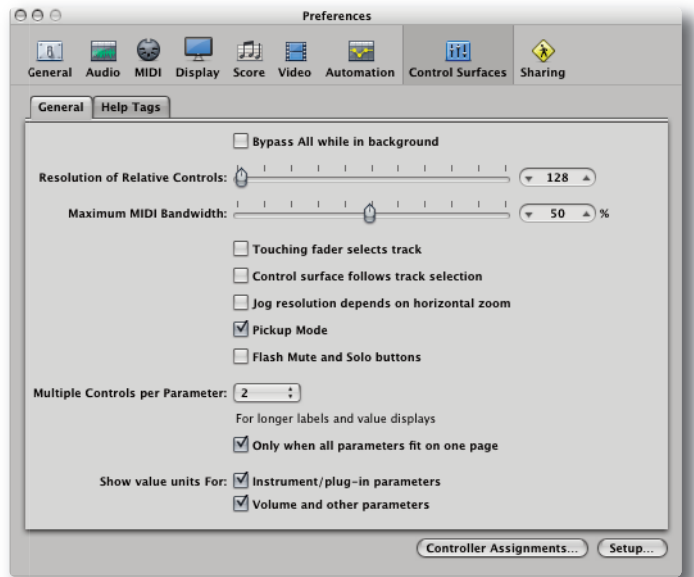

Control tracks must be Tracks 1-16 in the session.

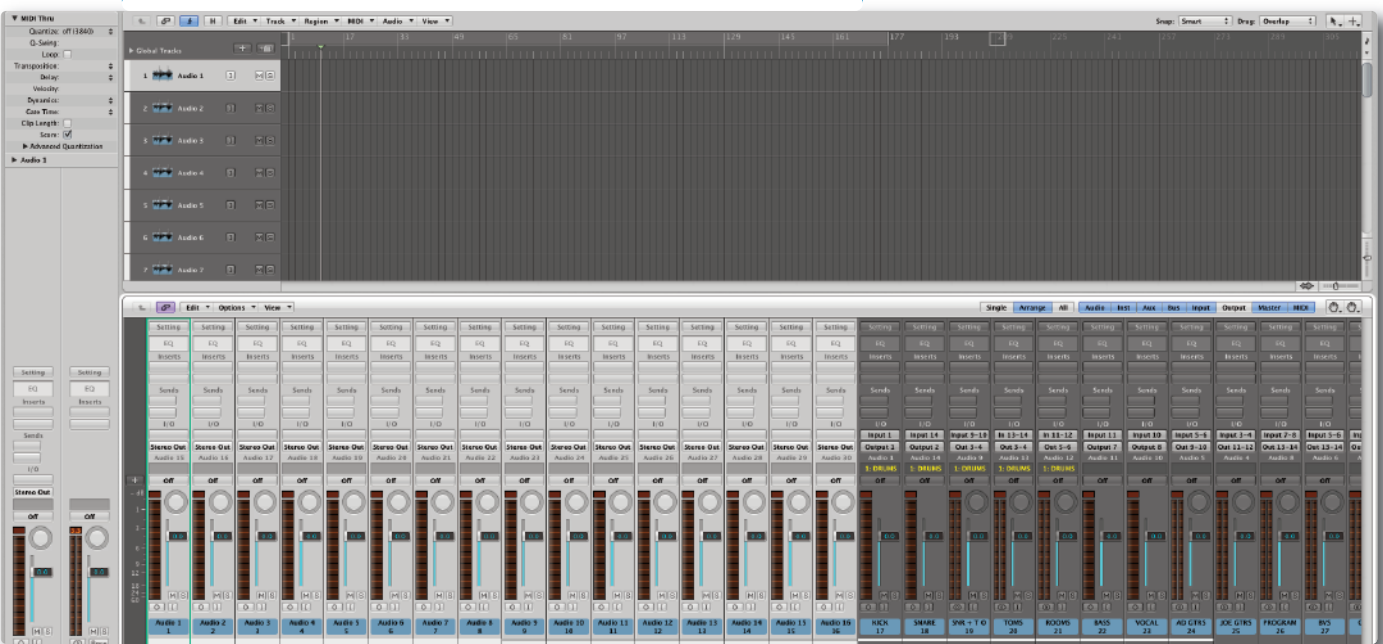

4. It is recommended to set the Logic Mixer to **'Arrange'** view mode. This ensures that the first 16 'control tracks' always correspond to Sigma's 16 analogue gains. If using Instrument tracks with Multi Outputs, also ensure that the **'Link'** button is **disabled**, to prevent Logic automatically switching back to **'All'** view mode when you click on an instrument.



*Note: These 16 audio tracks must be positioned as the first 16 in the session, as the HUI/MCU protocols dictate this. Pan information is not read, you must set the pan in the **CHANNELS** page of Sigma browser.*

*Tip: You probably want to rename these Audio Tracks to meaningful names such as 'KICK' instead of Audio1. Once you have done this in the DAW, go to the **CHANNELS** page in the web browser and click the **DAW > NAMES** button in the global menu. This will copy across the names of the 16 tracks.*

LOGIC + SIGMA + AVID® ARTIST SERIES CONTROL SURFACE (EUCON)

In this example we will configure Sigma to work together with a Artist Series Control Surface such as the **Artist Control®**. The MCU and Eucon protocols are able to work simultaneously. When using a Eucon control surface, banking is done in the Eucon domain and does not affect automation streams on Sigma.

In this example we will configure Sigma to work with Logic on ipMIDI channels 1 and 2.

Sigma Browser Settings

We will set up Sigma to work on ipMIDI channels 1 & 2.

1. Go to the **SETTINGS** page in the Sigma browser.
2. Set **DAW/PROTOCOL** to **LOGIC (MCU)** from the drop-down box.
3. Set **CHANNELS 1-8** to **ipMIDI Port 1** and set **CHANNELS 9-16** to **ipMIDI Port 2**.

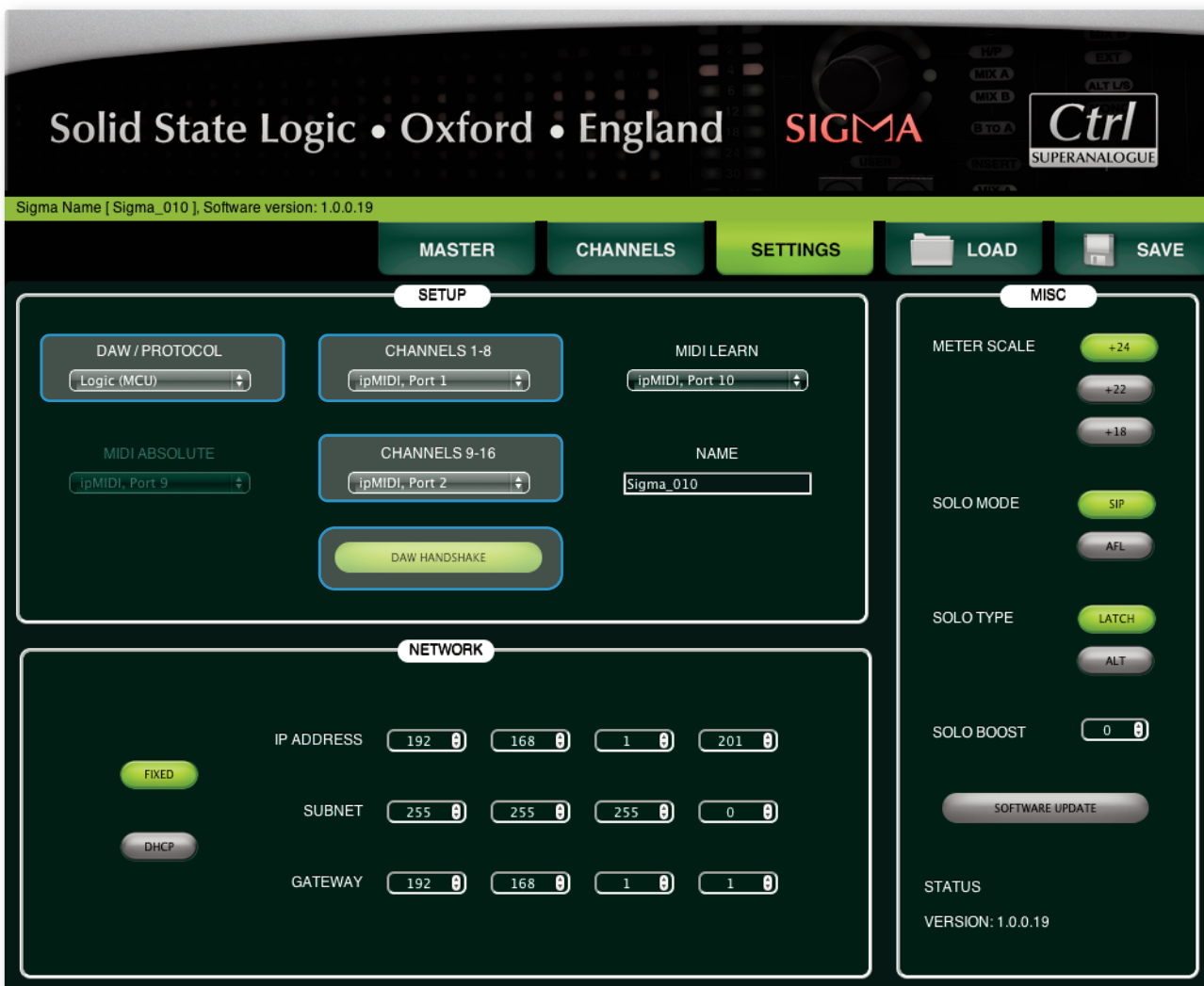

Artist Controller Settings

You should not be required to set up any additional functionality on your Artist Controller. As you will know, Eucon does not appear in the Control Surfaces Setup of Logic, it is just part of Logic Pro 9.

Logic Control Surface Settings

First, we'll set up Sigma.

1. Open Logic.
2. Go to **Preferences > Control Surfaces Setup...**
3. Choose **New** and then **Install...**
4. Select a **Mackie Designs - Mackie Control** and click **Add**.
5. Set the **Output Port** and **Input Port** to **Port 1**.
6. Now select a **Mackie Designs - Mackie Control Extender** from the list and click **Add**.
7. Set the **Output Port** and **Input Port** to **Port 2**.

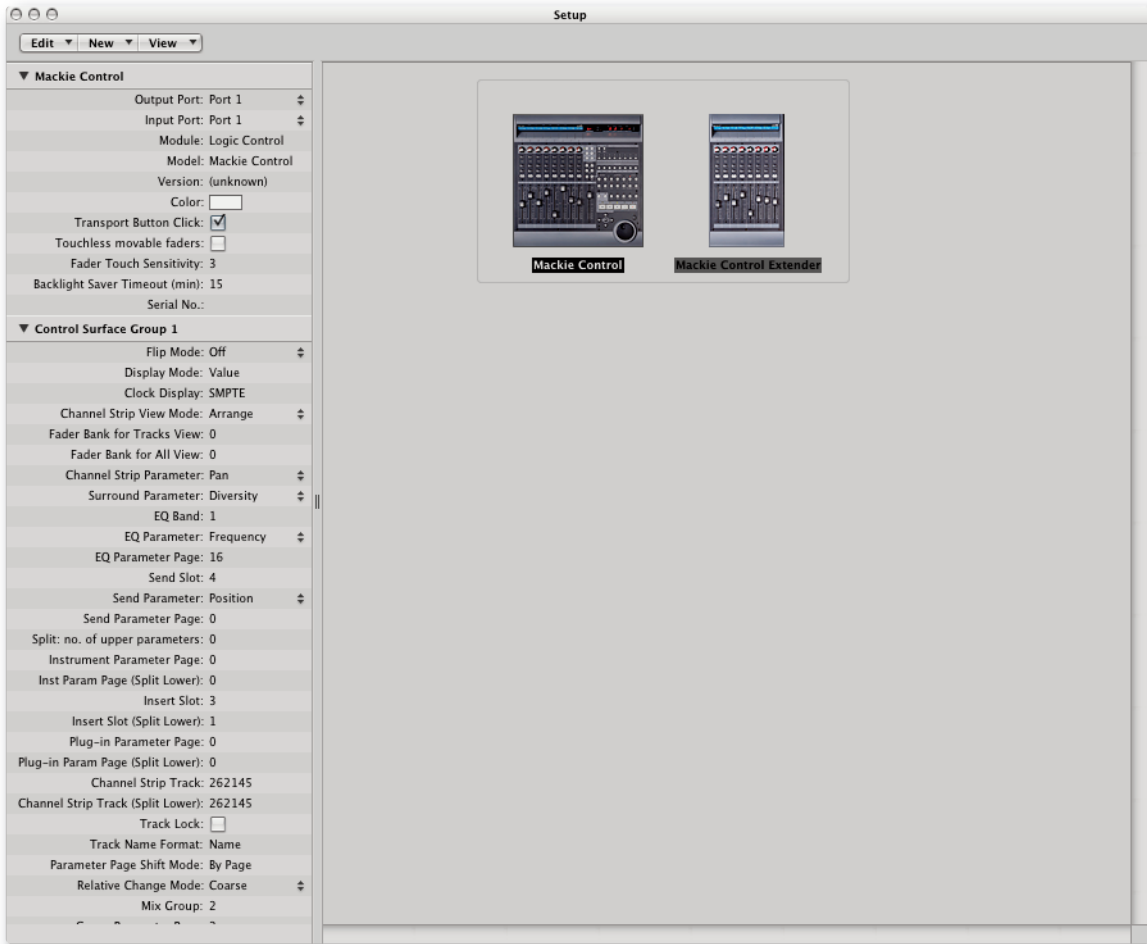

*Important: Please ensure you are selecting the **Mackie Designs - Mackie Control Surface** and **NOT** the **Mackie Designs - Logic Control Surface**. The Logic Control Surface sends different messages and Sigma will not respond to these.*

Logic Session Setup

The final step is to create 16 new tracks which will be our dedicated fader controls for each of Sigma's analogue channels.

1. Use the **+** button and to create **16** new **Audio Tracks** (it does not matter if they are mono or stereo)
2. Make sure that these 16 audio tracks are positioned as the first 16 tracks of the session

Any volume automation data or fader movements on these 16 tracks will control the analogue gains of Sigma.

3. Your existing tracks with audio recorded to them should be routed out of different outputs on your audio interface, which will then feed the appropriate Sigma inputs channels (just like you would do with any normal summing unit).

Control tracks must be Tracks 1-16 in the session.



4. It is recommended to set the Logic Mixer to **'Arrange'** view mode. This will ensure that the first 16 'control tracks' always correspond to Sigma's 16 analogue gains. If using Instruments tracks with Multi Outputs, also ensure that the **'Link'** button is **disabled**, to prevent Logic automatically switching back to the **'All'** view mode when you click on an instrument.



Notes:

These 16 audio tracks must be positioned as the first 16 in the session, as the HUI/MCU protocols dictate this. Pan information is not read, you must set the pan in the **CHANNELS** page of Sigma browser.

Tip: You probably want to rename these Audio Tracks to meaningful names such as 'KICK' instead of Audio1. Once you have done this in the DAW, go to the **CHANNELS** page in the web browser and click the **DAW > NAMES** button in the global menu. This will copy across the names of the 16 tracks.

CUBASE/NUENDO + SIGMA (NO CONTROL SURFACE)

In this example we will configure Sigma to work with Cubase/Nuendo on ipMIDI channels 1 and 2.

Sigma Browser Settings

1. Go to the **SETTINGS** page in the Sigma browser.
2. Set the **DAW/PROTOCOL** to be **CUBASE/NUENDO (MCU)** from the drop-down box
3. Set **CHANNELS 1-8** to **ipMIDI Port 1** and set **CHANNELS 9-16** to **ipMIDI Port 2** .



Cubase/Nuendo Settings

1. Open Cubase/Nuendo.
2. Go to **Devices > Device Setup...** and then go to **Remote Devices**.
3. Click the '+' button to add in a **Mackie Control**. Set the **MIDI Input** and **MIDI Output Ports** to **ipMIDI Port 2**.
(Cubase requires the ipMIDI ports to be configured in reverse order).
4. Click '+' to add in a second **Mackie Control**. Set the **MIDI Input** and **MIDI Output Ports** to **ipMIDI Port 1**.
5. Click **Apply** and click **OK**.

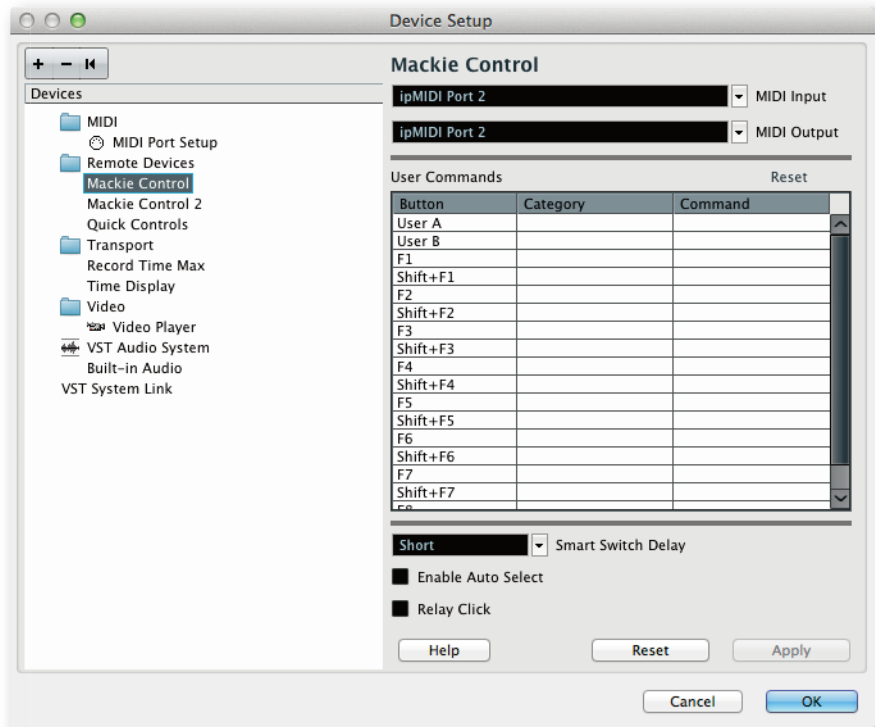

Session Setup

The final step is to create 16 new tracks which will be our dedicated fader controls for each of Sigma's analogue channels.

1. Go to **Project** and **Add track > Audio...**
2. Create 16 new blank **Audio Tracks** (it does not matter if they are mono or stereo).
3. Make sure that these 16 audio tracks are positioned as the first 16 tracks of the session.

Any volume automation data or fader movements on these 16 tracks will control the analogue gains of Sigma.

4. Your existing tracks with audio recorded to them should be routed out of different outputs on your audio interface, which will then feed the appropriate Sigma inputs channels (just like you would do with any normal summing unit).

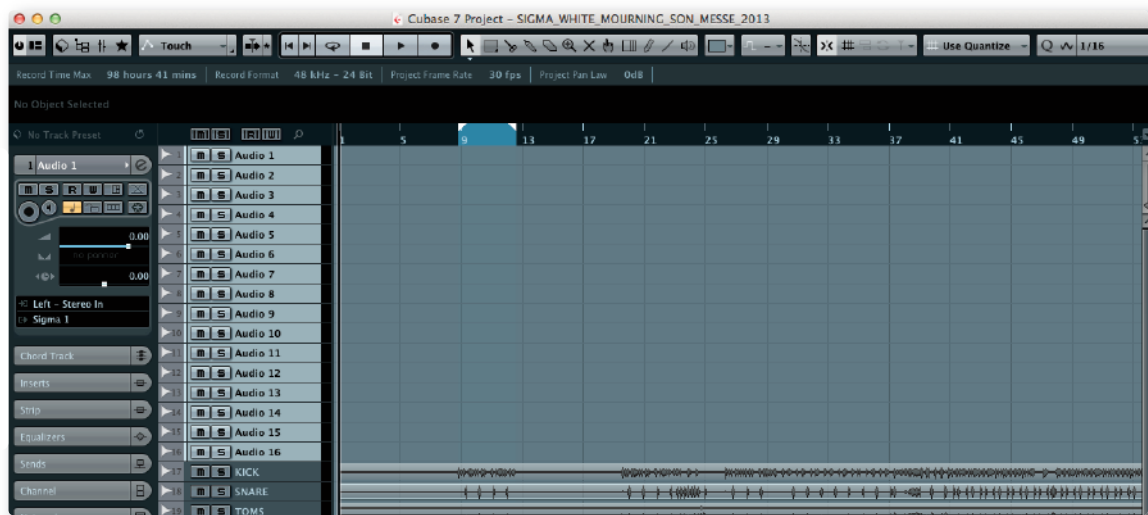

*Notes: These 16 audio tracks must be positioned as the first 16 in the session, as the HUI/MCU protocols dictate this. Pan information is not read, you must set the pan in the **CHANNELS** page of Sigma browser.*

*Tip: You probably want to rename these Audio Tracks to meaningful names such as 'KICK' instead of Audio1. Once you have done this in the DAW, go to the **CHANNELS** page in the web browser and click the **DAW > NAMES** button in the global menu. This will copy across the names of the 16 tracks.*

CUBASE/NUENDO + SIGMA + NUCLEUS (OR ANY STANDARD MCU CONTROL SURFACE)

In this example we will configure Sigma to work together with a Nucleus. You could follow the setup procedure for Cubase/Nuendo + Sigma (No Control Surface) however, when using a MCU controller, banking through channels will misalign the automation data. e.g. if you use the 'Channel Right' button a Nucleus to make the second track in the session appear on Channel 1 of Nucleus, your automation stream from the second track in your DAW will drive the first analogue channel of Sigma - not what we want!

To solve this problem, we have provided a **MIDI** automation mode, as found in our Matrix console. This mode works by using MIDI tracks in your session to control the analogue gains directly, rather than over the HUI/MCU protocols. Therefore, banking does not have any unwanted effects on the automation data.

Sigma Browser Settings

1. Go to the **SETTINGS** page in the Sigma browser.
2. Set **DAW/PROTOCOL** to **MIDI** from the drop-down box.
3. Go to the **MIDI ABSOLUTE** mode and pick an **ipMIDI Port** - e.g. **Port 9**.

*Note that the **CHANNELS 1-8** and **CHANNELS 9-16** boxes have no effect when using MIDI.*



Cubase/Nuendo Settings

1. Open Cubase/Nuendo.
2. Have the **Setup > Peripherals... > MIDI Controllers** configured as you would normally for your Nucleus (or MCU) controller e.g. The screenshot shows a Nucleus setup for use on DAW Layer 1. Note that with this setup, this is not how the analogue gains of Sigma are driven. That will be done over the MIDI tracks in the following steps...

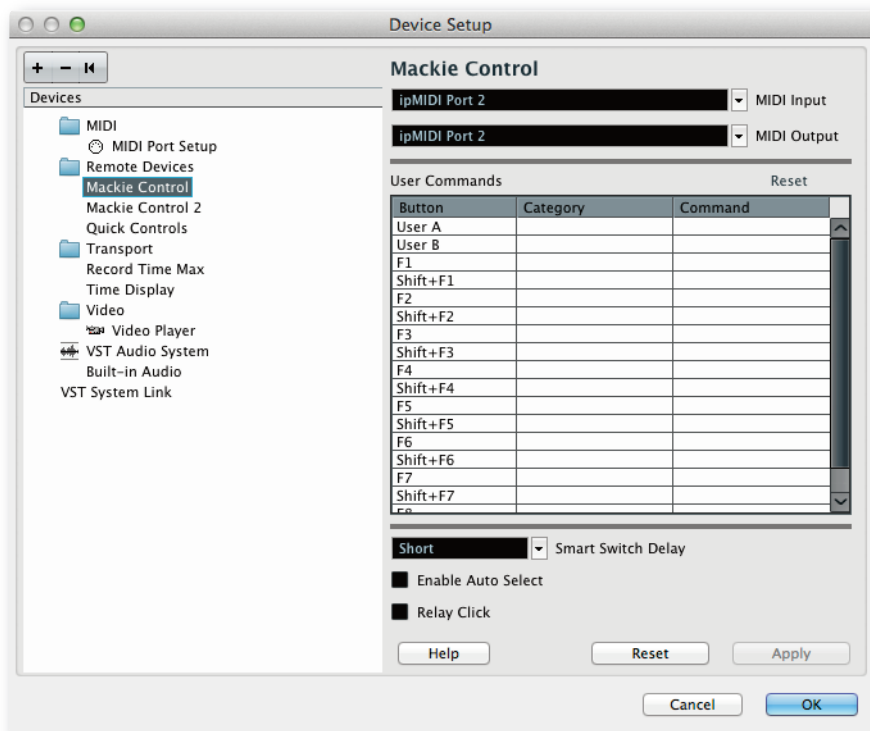

Cubase Session Setup

The final step is to create 16 new tracks which will be our dedicated fader controls for each of Sigma's analogue channels.

1. Go to Project and Add track > MIDI...
2. Create 16 new MIDI Tracks (it does not matter where they are positioned in the session).
3. Set the output of the first MIDI track to ipMIDI Port 9, channel-1 .
4. Continue setting the outputs in this way incrementally to get all 16 channels e.g. The second MIDI track is set to output on ipMIDI Port 9, channel-2, the third MIDI track is set to output on ipMIDI Port 9, channel-3, etc.

Any volume automation data or fader movements on these 16 MIDI tracks will control the analogue gains of Sigma.

5. Your existing tracks with audio recorded to them should be routed out of different outputs on your audio interface, which will then feed the appropriate Sigma inputs channels (just like you would do with any normal summing unit).

Outputs set to ipMidi port 9 on Channels 1-16

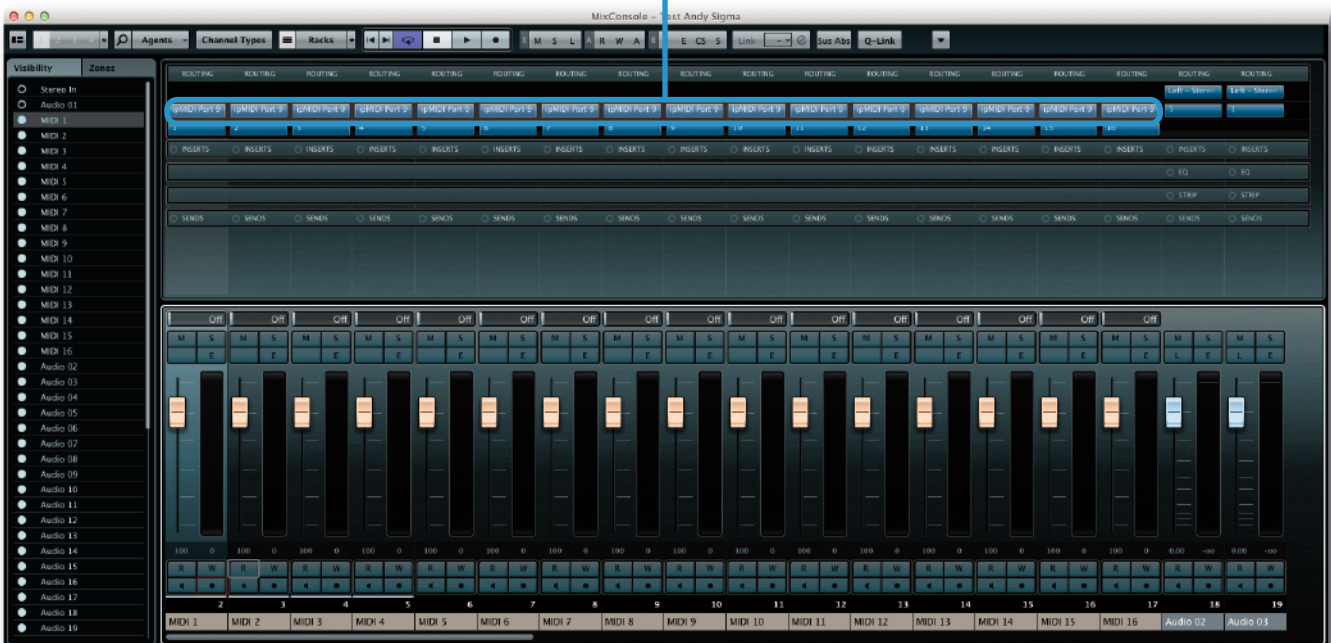

6. You will need to move the MIDI faders before their levels are picked up by Sigma.

Tip: When using MIDI Absolute, the volume information is being sent discreetly from the output of each MIDI track. This means that you can position these MIDI tracks anywhere in your DAW session. They do not have to be arranged as the first 16 tracks.

Notes:

Although MIDI faders have a maximum resolution 127 values, these values are scaled in such a way to provide smooth and natural volume automation in the useful range of fader travel.

Pan information is not read, you must set the pan in the CHANNELS page of Sigma browser.

CUBASE/NUENDO + SIGMA + AVID® ARTIST SERIES CONTROL SURFACE (EUCON)

In this example we will configure Sigma to work together with a Artist Series Control Surface such as the **Artist Control®**. The MCU and Eucon protocols are able to work simultaneously. When using a Eucon control surface, banking is done in the Eucon domain and does not affect automation streams on Sigma.

In this example we will configure Sigma to work with Pro Tools on ipMIDI channels 1 and 2.

Sigma Browser Settings

1. Go to the **SETTINGS** page in the Sigma browser.
2. Set the **DAW/PROTOCOL** to be **CUBASE/NUENDO (MCU)** from the drop-down box
3. Set **CHANNELS 1-8** to **ipMIDI Port 1** and set **CHANNELS 9-16** to **ipMIDI Port 2** .



Cubase/Nuendo Settings

1. Open Cubase/Nuendo.
2. Go to **Devices > Device Setup...** and then go to the **Remote Devices** section.
3. Click the **+** button to add in a **Mackie Control**. Set the **MIDI Input** and **MIDI Output Ports** to **ipMIDI Port 2**.
(Cubase requires the ipMIDI ports to be configured in reverse order).
4. Click the **+** button to add in a second **Mackie Control**. Set the **MIDI Input** and **MIDI Output Ports** to **ipMIDI Port 1**.
5. Click **Apply** and click **OK**.

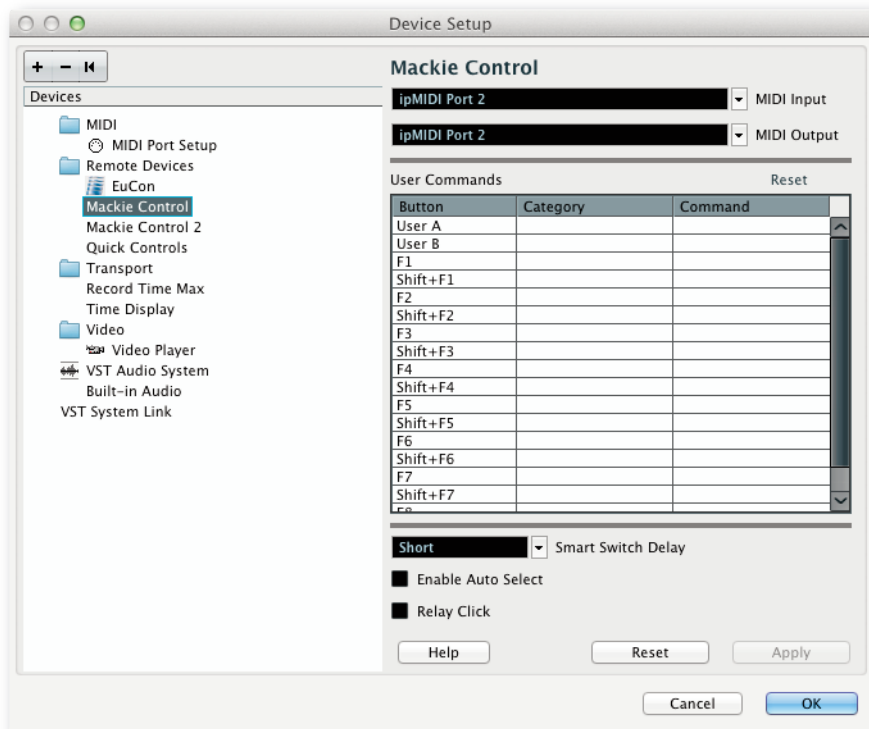

Artist Controller Settings

You should not be required to set up any additional functionality on your Artist Controller. It should be left configured as it normally is, in the Remote Devices section.

Cubase/Nuendo Session Setup

The final step is to create 16 new tracks which will be our dedicated fader controls for each of Sigma's analogue channels.

1. Go to **Project** and **Add track > Audio...**
2. Create 16 new blank **Audio Tracks** (it does not matter if they are mono or stereo).
3. Make sure that these 16 audio tracks are positioned as the first 16 tracks of the session.

Any volume automation data or fader movements on these 16 tracks will control the analogue gains of Sigma.

4. Your existing tracks with audio recorded to them should be routed out of different outputs on your audio interface, which will then feed the appropriate Sigma inputs channels (just like you would do with any normal summing unit).

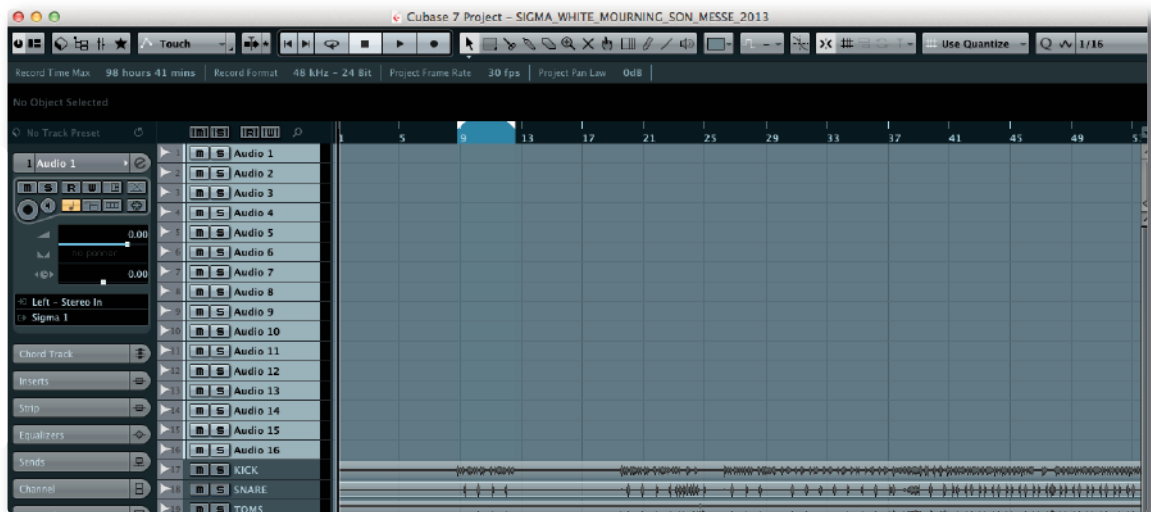
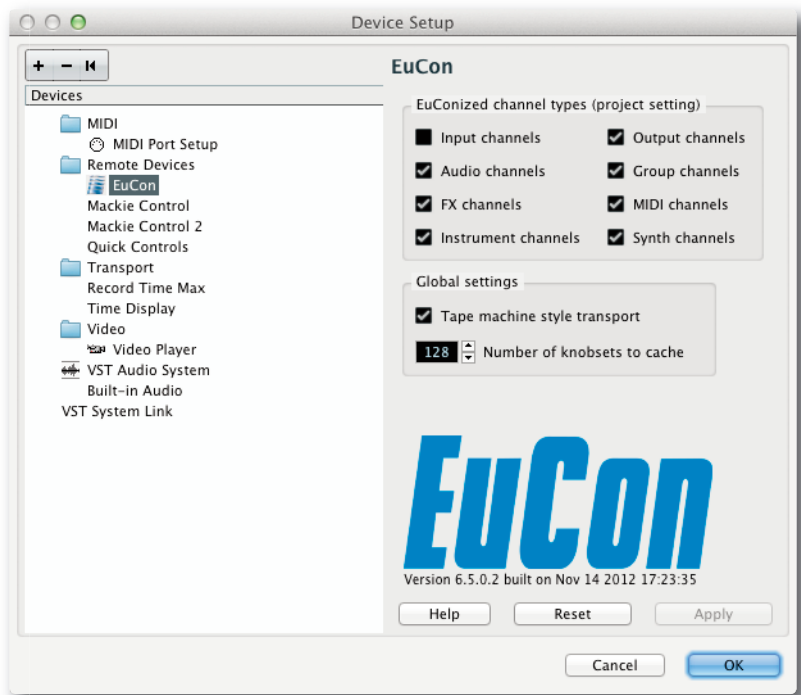

Notes:

These 16 audio tracks must be positioned as the first 16 in the session, as the HUI/MCU protocols dictate this. Pan information is not read, you must set the pan in the **CHANNELS** page of Sigma browser.

*Tip: You probably want to rename these Audio Tracks to meaningful names such as 'KICK' instead of Audio1. Once you have done this in the DAW, go to the **CHANNELS** page in the web browser and click the **DAW > NAMES** button in the global menu. This will copy across the names of the 16 tracks.*

ABLETON LIVE! + SIGMA (NO CONTROL SURFACE)

In this example we will configure Sigma to work with Ableton Live! on ipMIDI channels 1 and 2.

Sigma Browser Settings

1. Go to the **SETTINGS** page in the Sigma browser.
2. Set **DAW/PROTOCOL** to **ABLETON (MCU)** from the drop-down box.
3. Set **CHANNELS 1-8** to **ipMIDI Port 1** and set **CHANNELS 9-16** to **ipMIDI Port 2**.

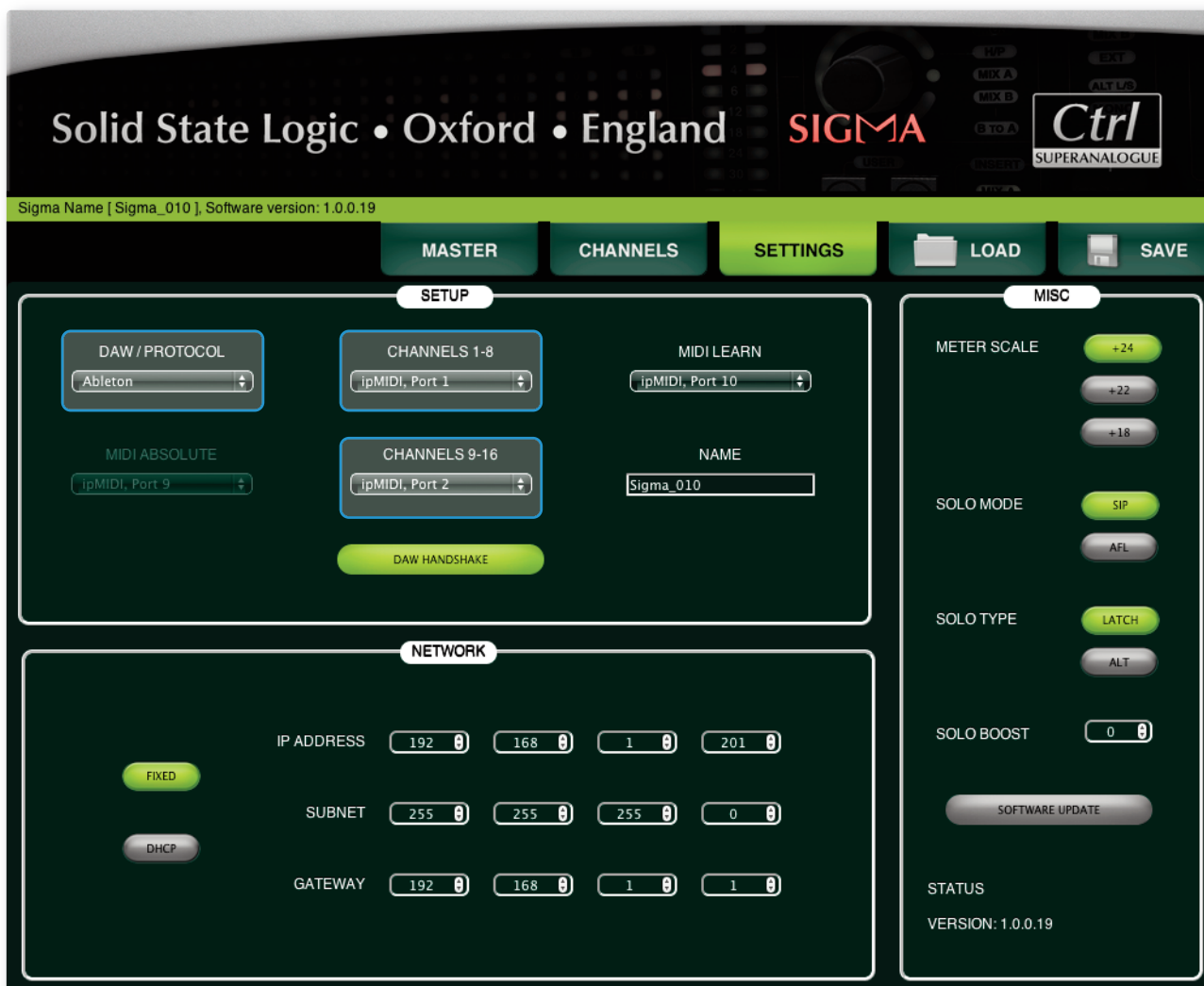

Ableton Live! Settings

1. Open Ableton Live!
2. Go to **Preferences > MIDI/SYNC** section.
3. Set the first **Control Surface**.
4. Click the **+** button to add in a second **Mackie Control**. Set the **MIDI Input** and **MIDI Output Ports** to **ipMIDI Port 1**.
5. Click the **+** button to add in a **Mackie Control XT**. Set the **Input** and **Output Ports** to **ipMIDI Port 2**.

Ableton Live! Session Setup

The final step is to create 16 new tracks which will be our dedicated fader controls for each of Sigma's analogue channels.

1. Go to **Create and Insert Audio Track**.
2. Create 16 new blank **Audio Tracks** (it does not matter if they are mono or stereo)
3. Make sure that these 16 audio tracks are positioned as the first 16 tracks of the session

Any volume automation data or fader movements on these 16 tracks will control the analogue gains of Sigma.

4. Your existing tracks with audio recorded to them should be routed out of different outputs on your audio interface, which will then feed the appropriate Sigma inputs channels (just like you would do with any normal summing unit).

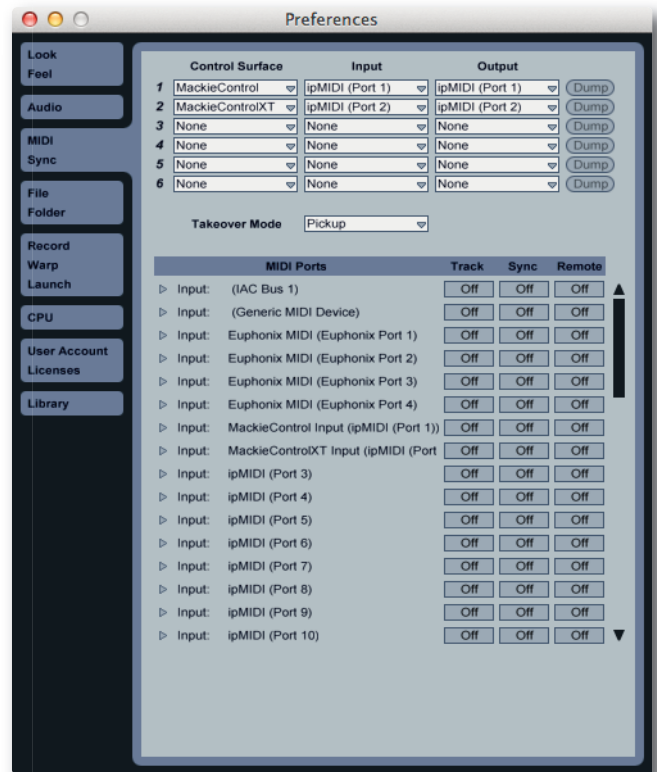

Control tracks must be Tracks 1-16 in the session.

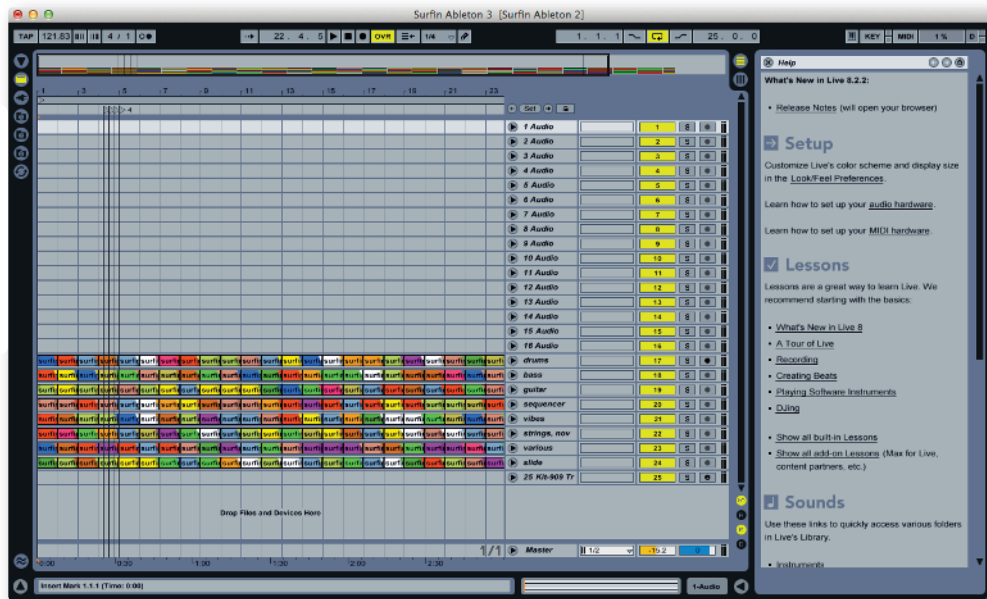

Notes:

These 16 audio tracks must be positioned as the first 16 in the session, as the HUI/MCU protocols dictate this. Pan information is not read, you must set the pan in the **CHANNELS** page of Sigma browser.

Tip: You probably want to rename these Audio Tracks to meaningful names such as 'KICK' instead of Audio1. Once you have done this in the DAW, go to the **CHANNELS** page in the web browser and click the **DAW > NAMES** button in the global menu. This will copy across the names of the 16 tracks.

ABLETON LIVE! + SIGMA (WITH MCU CONTROL SURFACE)

If you wish to use Ableton Live with a control surface such as Nucleus, you should configure it using the same instructions as in the previous setup example (Ableton Live! + Sigma). Be aware that Ableton does not support control surface grouping, so using banking functions on your MCU controller will mis-align the automation streams Sigma receives.

USING SIGMA WITH OTHER DAWS

This mode will work for any DAW that supports MIDI channels with faders. It works by using MIDI tracks in your session to control the analogue gains directly, rather than over the HUI/MCU protocols. This also means that if you have a control surface, banking does not have any unwanted effects on the automation data.

Sigma Browser Settings

1. Go to the **Settings** page in the Sigma browser.
2. Set **DAW/PROTOCOL** to **MIDI** from the drop-down box.
3. Disable the **HANDSHAKING** button.
4. Go to the **MIDI ABSOLUTE** mode and pick an **ipMIDI Port** - e.g. **Port 9**.

*Note that the **CHANNELS 1-8** and **CHANNELS 9-16** boxes have no effect when using MIDI.*

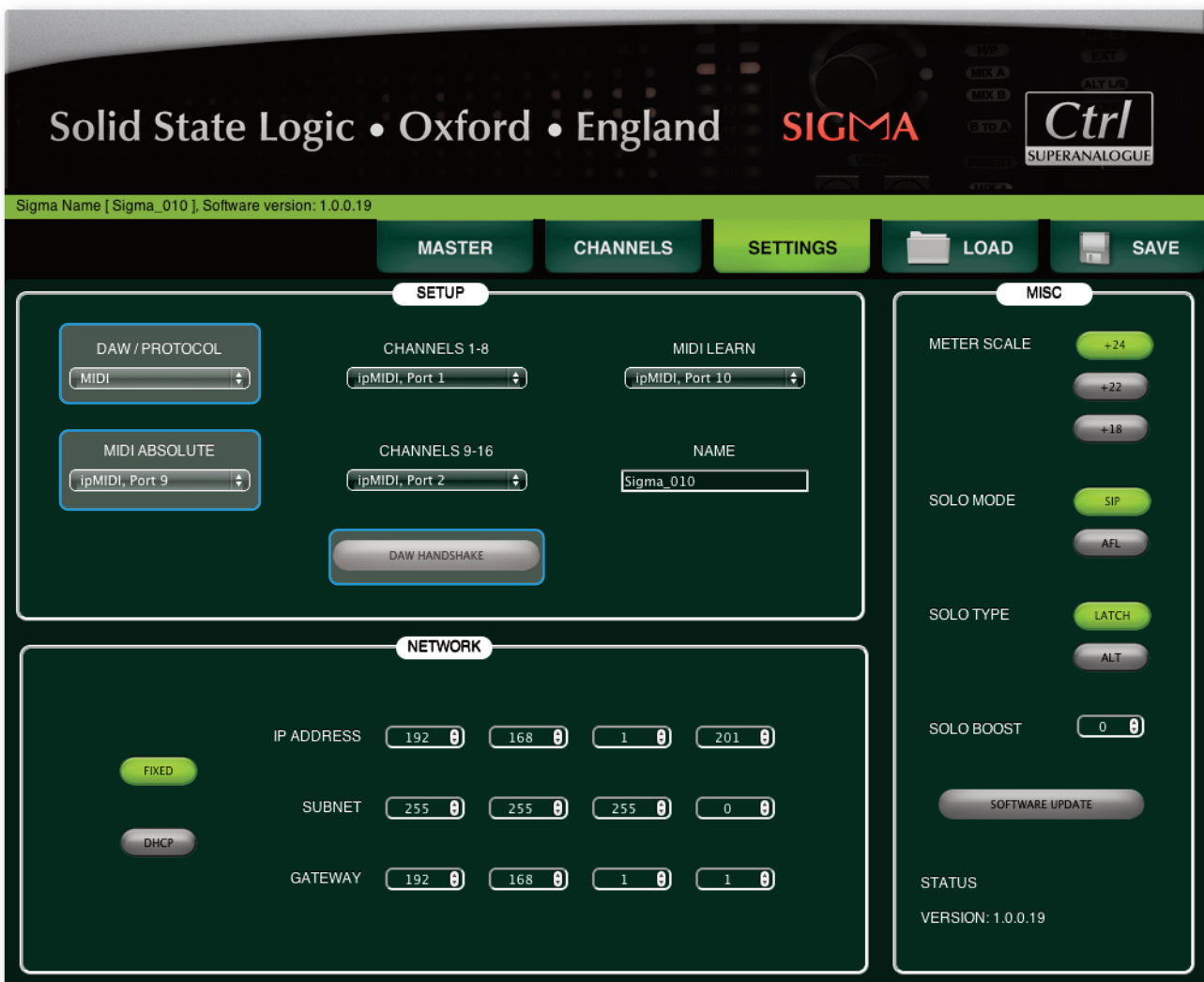

Session Setup

We have used Pro Tools as an example.

1. Open your DAW.
2. Create 16 new MIDI Tracks (it does not matter where they are positioned in the session).
3. Set the output of the first MIDI track to **ipMIDI Port 9, channel-1**.
4. Continue setting the outputs in this way incrementally to get all 16 channels e.g. The second MIDI track is set to output on **ipMIDI Port 9, channel-2**.

Any volume automation data or fader movements on these 16 MIDI tracks will control the analogue gains of Sigma.

6. Your existing tracks with audio recorded to them should be routed out of different outputs on your audio interface, which will then feed the appropriate Sigma inputs channels (just like you would do with any normal summing unit).

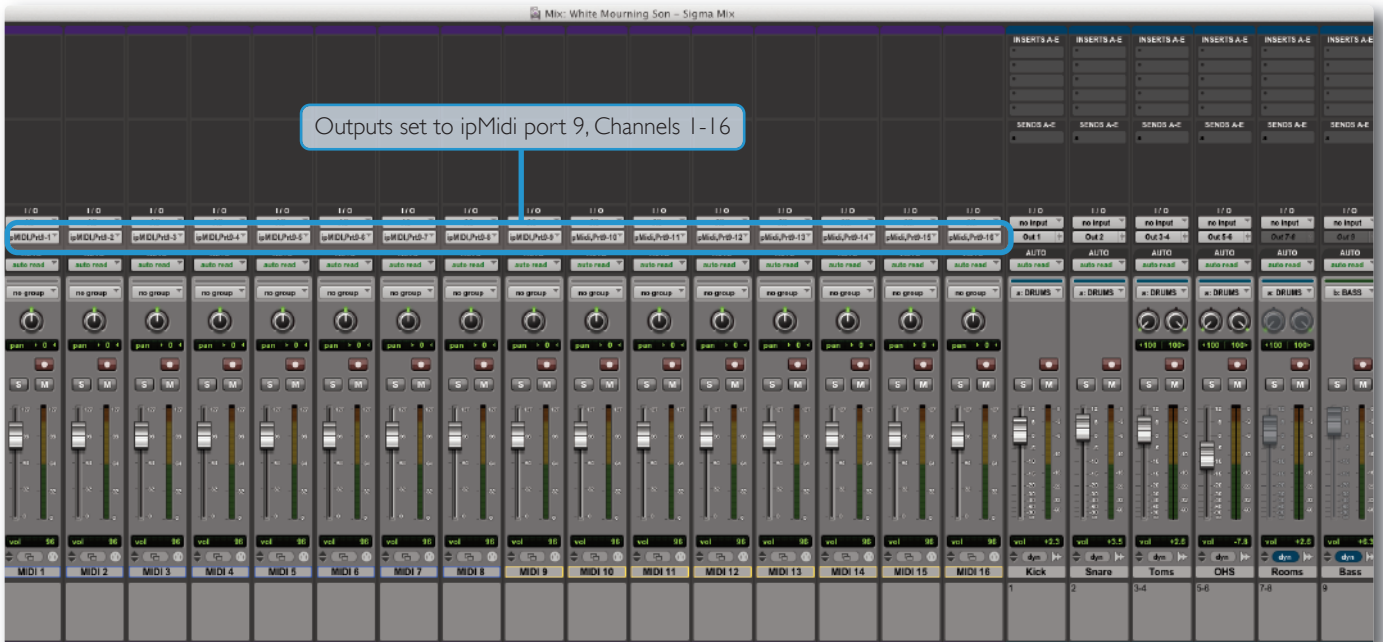

7. You will need to move the MIDI faders before their levels are picked up by Sigma.
8. We recommend you use Pro Tools' **Solo Safe** feature to Solo Safe the 16 MIDI tracks. This will ensure that when you solo one of your audio tracks in Pro Tools, the automation data will still be read.

*Tip: When using **MIDI Absolute**, the volume information is being sent discreetly from the output of each MIDI track. This means that you can position these MIDI tracks anywhere in your DAW session. They do not have to be arranged as the first 16 tracks.*

Notes:

Although MIDI faders have a maximum resolution 127 values, these values are scaled in such a way to provide smooth and natural volume automation in the useful range of fader travel.

*Pan information is not read, you must set the pan in the **CHANNELS** page of Sigma browser.*

USING TWO SIGMAS TOGETHER

If using two Sigmas, ensure that the following has been set up:

- Each Sigma has a different fixed IP address or you are using DHCP
- If using HUI/MCU, each Sigma should be set for different ipMIDI Ports, for example:
 - Sigma 1 - Set to Ports 1 & 2.
 - Sigma 2 - Set to Ports 3 & 4.
- You will need to have four HUI/MCU Controllers setup in your DAW, outputting to each of these ports accordingly.

The first 32 tracks of your session would then control the analogue gains.

- If using MIDI Absolute, each Sigma should be set to different ipMIDI Ports, for example:
 - Sigma 1 - Set to Port 9.
 - Sigma 2 - Set to Port 10.
- If using MIDI Absolute, you will need to create 32 MIDI tracks, with the first 16 channels set to Port 9 and the second 16 channels set to Port 10.

*TIP: A good way of linking the audio from two Sigmas is using the **SUM** feature on the Mix Bus Insert. Connect the **MIX A** output of your second Sigma unit into the Insert Return of **Mix Bus A** on the first Sigma. Engage the sum function. This will sum Mix A from your second Sigma with Mix A from your first Sigma.*

Appendices

APPENDIX A - CONNECTORS & PINOUTS

'CHIP' – Channel Input Connectors †

Connector Type: 25-way D-type Female

Pin	Description
1	Channel 4 Right (+ve)
14	Channel 4 Right (-ve)
2	0V
15	Channel 4 Left (+ve)
3	Channel 4 Left (-ve)
16	0V
4	Channel 3 Right (+ve)
17	Channel 3 Right (-ve)
5	0V
18	Channel 3 Left (+ve)
6	Channel 3 Left (-ve)
19	0V
7	Channel 2 Right (+ve)
20	Channel 2 Right (-ve)
8	0V
21	Channel 2 Left (+ve)
9	Channel 2 Left (-ve)
22	0V
10	Channel 1 Right (+ve)
23	Channel 1 Right (-ve)
11	0V
24	Channel 1 Left (+ve)
12	Channel 1 Left (-ve)
25	0V
13	n/c

'CHOP' – Channel Output Connectors †

Connector Type: 25-way D-type Female

Pin	Description
1	Channel 4 Right (+ve)
14	Channel 4 Right (-ve)
2	0V
15	Channel 4 Left (+ve)
3	Channel 4 Left (-ve)
16	0V
4	Channel 3 Right (+ve)
17	Channel 3 Right (-ve)
5	0V
18	Channel 3 Left (+ve)
6	Channel 3 Left (-ve)
19	0V
7	Channel 2 Right (+ve)
20	Channel 2 Right (-ve)
8	0V
21	Channel 2 Left (+ve)
9	Channel 2 Left (-ve)
22	0V
10	Channel 1 Right (+ve)
23	Channel 1 Right (-ve)
11	0V
24	Channel 1 Left (+ve)
12	Channel 1 Left (-ve)
25	0V
13	n/c

Main Monitor Output

Connector Type: XLR 3-pin Male

Pin	Description
1	0V (Chassis)
2	Signal +ve
3	Signal -ve

Alternate Monitor Output

Connector Type: XLR 3-pin Male

Pin	Description
1	0V (Chassis)
2	Signal +ve
3	Signal -ve

Mix A Output

Connector Type: XLR 3-pin Male

Pin	Description
1	0V (Chassis)
2	Signal +ve
3	Signal -ve

EXT, RTNS, T/B †

Connector Type: 25-way D-type Female

*D-sub to
XLR-F
Loom*

Pin	Description	
1	n/c	
14	n/c	XLR-8
2	0V	
15	Talkback Mic Input (+ve)	
3	Talkback Mic Input (-ve)	XLR-7
16	0V	
4	Mix B Insert Return Right (+ve)	
17	Mix B Insert Return Right (-ve)	XLR-6
5	0V	
18	Mix B Insert Return Left (+ve)	
6	Mix B Insert Return Left (-ve)	XLR-5
19	0V	
7	Mix A Insert Return Right (+ve)	
20	Mix A Insert Return Right (-ve)	XLR-4
8	0V	
21	Mix A Insert Return Left (+ve)	
9	Mix A Insert Return Left (-ve)	XLR-3
22	0V	
10	External Input Right (+ve)	
23	External Input Right (-ve)	XLR-2
11	0V	
24	External Input Left (+ve)	
12	External Input Left (-ve)	XLR-1
25	0V	
13	n/c	

MIX B, SENDS, H/P †

Connector Type: 25-way D-type Female

*D-sub to
XLR-M
Loom*

Pin	Description	
1	Headphone Right (+ve, line level)	
14	Headphone Right (-ve, line level)	XLR-8
2	0V	
15	Headphone Left (+ve, line level)	
3	Headphone Left (-ve, line level)	XLR-7
16	0V	
4	Mix B Insert Send Right (+ve)	
17	Mix B Insert Send Right (-ve)	XLR-6
5	0V	
18	Mix B Insert Send Left (+ve)	
6	Mix B Insert Send Left (-ve)	XLR-5
19	0V	
7	Mix A Insert Send Right (+ve)	
20	Mix A Insert Send Right (-ve)	XLR-4
8	0V	
21	Mix A Insert Send Left (+ve)	
9	Mix A Insert Send Left (-ve)	XLR-3
22	0V	
10	Mix B Output Right (+ve)	
23	Mix B Output Right (-ve)	XLR-2
11	0V	
24	Mix B Output Left (+ve)	
12	Mix B Output Left (-ve)	XLR-1
25	0V	
13	n/c	

Headphones

Connector Type: 0.25" Stereo Jack

	Description
Tip	Signal Left
Ring	Signal Right
Sleeve	0V (Chassis)

iJack Input

Connector Type: 3.5mm Stereo Jack

	Description
Tip	Signal Left
Ring	Signal Right
Sleeve	0V (Chassis)

Foot Switch Input

Connector Type: 0.25" Stereo Jack

	Description
Tip	Signal
Ring	0V (Chassis)
Sleeve	0V (Chassis)

†: D-type connector wiring follows AES59 ('Tascam') standard and binding posts are 4-40 UNC thread.

APPENDIX B - SIGNAL FLOW BLOCK DIAGRAM

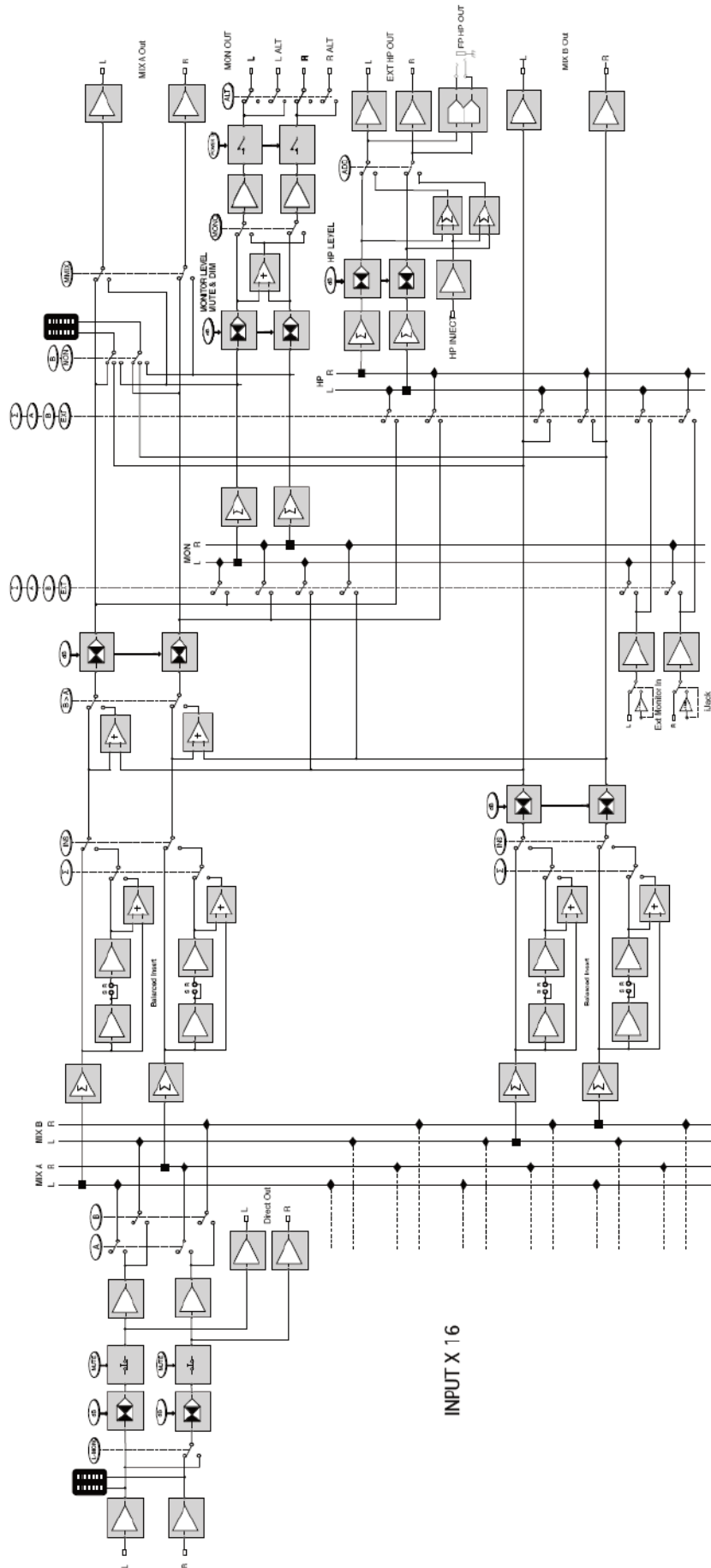

APPENDIX C - SUPPORT

FAQs

Support information for the entire SSL WPP range is always available through our online support site:

www.solidstatelogic.com/support

If you can't find the answer or solution for your particular issue, questions and queries can be submitted to our support staff.

HOME NEWS PRODUCTS SUPPORT STUDIO DIRECTORY STORE WHERE TO BUY ABOUT LOGIN REGISTER

Solid State Logic
SOUND | VISION

Support

FAQs, documentation and other useful utilities

A great product is only the start of what sets SSL equipment apart. We believe that the world's best products demand the best support. To provide this, SSL has a network of sales and service centres throughout the world, including its subsidiaries in New York, Los Angeles, Paris and Milan. Through these offices, and appointed distributors in other countries, a full program of backup and technical support is guaranteed. Underpinning all this local expertise is the global support available from SSL's service centre at the company headquarters near Oxford, England.

- Console Resources**
 - Duality SE
 - AWS 924/948
 - AWS 900
 - Matrix
 - X-Desk
 - C10 HD
- Duende**
 - Duende Native
 - Legacy Duende DSP
 - Plug-ins
- Audio I / O**
 - Alpha-Link Range
 - Delta-Link MADI-HD
 - MADI-X8
 - MX4
 - MadiXtreme
 - SDI-MADI
- Workstation Products**
 - Nucleus
 - Soundscape
 - Live-Recorder
 - Pro-Convert
 - X-ISM Plug-in
 - LMC-1 Plug-in
- Analogue Outboard**
 - X-Rack
 - X-Desk
 - Mynx
 - X-Patch
 - G Series Bus Comp
 - Alpha Channel

Solid State Logic
SOUND | VISION

Required Software

In order for Sigma to integrate with your DAW, ipMIDI software must be installed on your computer. In addition, configuration of Sigma will require the use of a web browser (Chrome, Firefox, Safari, Internet Explorer).

Important: Please check the SSL website for tested web browser versions and compatibility.

Please navigate to the Sigma page on the Solid State Logic website and click the Downloads tab. From here you will be prompted to register.

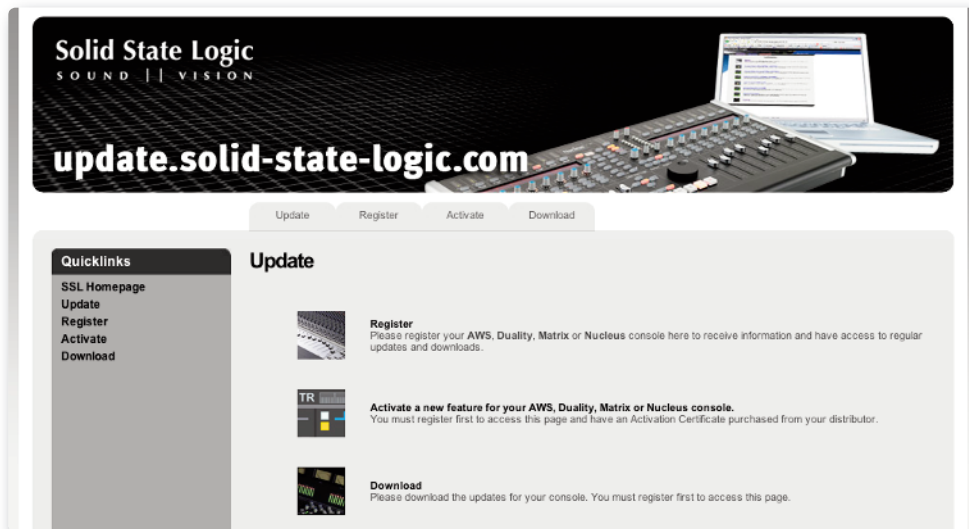

Once registered, you will be able to sign-in and download the ipMIDI software which allows Sigma to work with your DAW.

Sigma's Internal Software

The **SOFTWARE UPDATE** button (found in the **SETTINGS** page of the web browser) is used to update Sigma's internal software. You must have the ethernet cable connected to perform the update. Below the button you will see the current version of Sigma software you are running. There may be infrequent updates provided for Sigma. The **.bin** file used to update Sigma's software will be available from the SSL website. Go to the Sigma product page and go to the **Downloads** tab to login and download.

After downloading the **.bin** file, click on the **SOFTWARE UPDATE** button and locate the downloaded **.bin** file. Follow the onscreen instructions.



IMPORTANT - After updating your Sigma software and restarting, you will need to clear your web browser's Cache in order for all changes to take effect. You may also need to Refresh the page.

Hardware

The diagram below can be used in conjunction with our troubleshooting support videos for replacing Sigma's hardware.

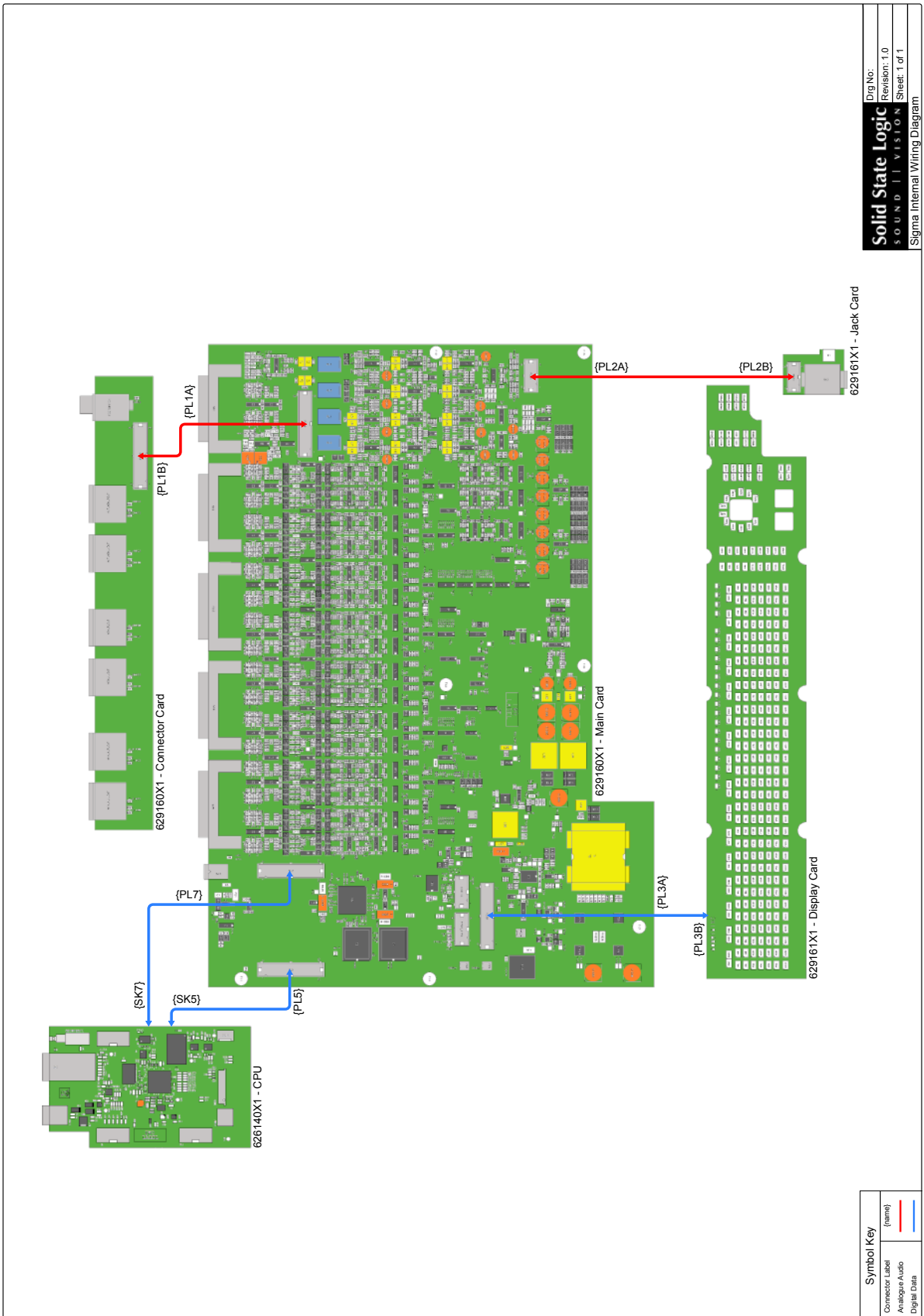

Dig No:
Revision: 1.0
Revision: 1.0
Sheet: 1 of 1
Sigma Internal Wiring Diagram

APPENDIX D

Specifications - Technical & Environmental

Physical *

Depth	320mm / 12.75"	<i>casing only</i>
Height	89mm / 3.5" (2 RU)	
Width	435mm / 17" 482mm / 19"	<i>casing only inc' rack ears</i>
Weight	5kg / 11 pounds	
Power	< 60 Watts	
Boxed size	510mm x 570mm x 280mm 20" x 22.5" x 11"	
Boxed weight	10kg / 22 pounds	

* All values are approximate

Environmental

Temperature	Operating:	+5 to 30 deg. C
	Non-operating:	-20 to 50 deg. C
	Max. gradient:	15 deg. C/hour
Relative Humidity	Operating:	20 to 80%
	Non-operating:	5 to 90%
	Max. wet bulb: (non-condensing)	29 deg. C
Vibration	Operating:	< 0.2 G (3 – 100Hz)
	Non-operating:	< 0.4 G (3 – 100Hz)
Shock	Operating:	< 2 G (10ms max.)
	Non-operating:	< 10 G (10ms max.)
Altitude (above sea level)	Operating:	0 to 3000m
	Non-operating:	0 to 12000m

Connections

Power Supply	IEC320 3-pin connector, 100 – 240 Vac, 50 – 60 Hz
DC Power	2mm DC power jack, +12V, < 3A
Analogue I/O	25-pin D-type socket, balanced, Zin > 10kΩ, Zo ≈ 100Ω 3-pin XLR-M, balanced, Zo ≈ 100Ω
Headphones	Stereo 1/4" jack socket, Zo ≈ 75Ω
Footswitch	Stereo 1/4" jack socket (1 circuit)
ijack	Stereo 3.5mm jack socket, Zi ≈ 10k
Network	8P8c modular connector; 'RJ-45' type (100bT, Cat5)
USB	1 x type-B chassis socket (<i>SSL diagnostic use only</i>)

Performance

Maximum I/O Level	+18dBu, +22dBu or 24dBu
Frequency Response	20Hz – 40kHz ±0.3dB
THD + N	< 0.025% (20Hz – 20kHz)
Noise	
CHIP to CHOP	< -83dBu @ +24dBu (20Hz – 20kHz)
CHIP to MIX A	< -75dBu @ +24dBu (20Hz – 20kHz) (stereo, all channels routed)

Electro Magnetic Compatibility

EN55103-1:2009, EN55103-2:2009

Environment E4

Initial in-rush current	10A
5 sec in-rush current	10A

Braid-screened cables should be used where applicable

Star Quad cables should be used where applicable

EMC Performance Criteria

Line level inputs and outputs

Measure at mid-gain, noise <-56dBu

APPENDIX E

Limited Warranty

Warranty claims will only be accepted if the purchased product has been used for its intended purpose. Any purchased product used for an unintended purpose will not be eligible for warranty protection. For all warranty inquiries or claims please address your claim to the dealer that you purchased the product from – or to Solid State Logic if the purchase was directly from Solid State Logic – within a period of two months from the date on which you detected its lack of conformity with the terms of the warranty. **Please include your original proof of purchase when initiating the claim.**

- **Within the EU:** Pursuant to the Solid State Logic Terms and Conditions under European consumer law the purchaser has full statutory warranty rights for two years from the date of delivery of the product. The warranty is valid only in those Member States of the European Union (EU) who have adopted the applicable EU law into their national legislation. The applicable national legislation governing the sale of consumer goods is not affected by this warranty.
- **Outside of the EU:** Outside of the European Union a 12 month warranty from date of purchase is applicable.

Out of Warranty Repairs

In the event of a fault arising after the warranty period has expired the unit should be returned to Solid State Logic either directly or via your local dealer. You will be charged for the time spent on the repair (at Solid State Logic's current repair rate) plus the cost of parts and shipping. Note that no units can be accepted for repair without prior arrangement (see below).

All Returns

- No unit will be accepted for repair by Solid State Logic unless accompanied by a valid RMA (Return Material Authorisation) number, obtainable from Solid State Logic prior to shipping.
- All units should be shipped to Solid State Logic in suitable rigid packaging – Solid State Logic cannot be held responsible for any damage caused by shipping units in other packaging. In such cases Solid State Logic will return the unit in a suitable box, which you will be charged for.
- Do not include the power cable, manual or any other items – Solid State Logic can not guarantee to return them to you.

Solid State Logic

S O U N D | | V I S I O N

Visit SSL at: www.solidstatelogic.com

82BMSM01A

© Solid State Logic

All Rights reserved under International and Pan-American Copyright Conventions

Matrix, Nucleus, SSL and Solid State Logic are trademarks of Solid State Logic

All other product names and trademarks are the property of their respective owners and are hereby acknowledged

No part of this publication may be reproduced in any form or by any means, whether mechanical or electronic, without the written permission of Solid State Logic, Oxford, OX5 1RU, England

As research and development is a continual process, Solid State Logic reserves the right to change the features and specifications described herein without notice or obligation.

Solid State Logic cannot be held responsible for any loss or damage arising directly or indirectly from any error or omission in this manual.

E&OE