

User manual



DPX-1210H NET
DPX-1210S NET

dimmer pack

Musikhaus Thomann
Thomann GmbH
Hans-Thomann-Straße 1
96138 Burgebrach
Germany
Telephone: +49 (0) 9546 9223-0
E-mail: info@thomann.de
Internet: www.thomann.de

29.05.2020, ID: 469657_469658

Table of contents

| | | |
|----------|---|-----------|
| 1 | General information | 6 |
| | 1.1 Further information..... | 7 |
| | 1.2 Notational conventions..... | 8 |
| | 1.3 Symbols and signal words..... | 9 |
| 2 | Safety instructions | 11 |
| 3 | Features | 16 |
| 4 | Installation and starting up | 17 |
| 5 | Connections and controls | 19 |
| 6 | Operating | 25 |
| | 6.1 Main menu..... | 25 |
| | 6.2 DMX and Art-Net settings..... | 27 |
| | 6.3 Dimmer settings..... | 29 |
| | 6.4 Scenes..... | 32 |
| | 6.5 General Settings..... | 36 |
| | 6.6 System information..... | 43 |

| | | |
|----------|--|-----------|
| 7 | Technical specifications..... | 45 |
| 8 | Plug and connection assignment..... | 48 |
| 9 | Protecting the environment..... | 49 |



1 General information

This user manual contains important information on the safe operation of the device. Read and follow all safety notes and all instructions. Save this manual for future reference. Make sure that it is available to all persons using this device. If you sell the device to another user, be sure that they also receive this manual.

Our products and user manuals are subject to a process of continuous development. We therefore reserve the right to make changes without notice. Please refer to the latest version of the user manual which is ready for download under www.thomann.de.

1.1 Further information

On our website (www.thomann.de) you will find lots of further information and details on the following points:

| | |
|-----------------------|---|
| Download | This manual is also available as PDF file for you to download. |
| Keyword search | Use the search function in the electronic version to find the topics of interest for you quickly. |
| Online guides | Our online guides provide detailed information on technical basics and terms. |
| Personal consultation | For personal consultation please contact our technical hotline. |
| Service | If you have any problems with the device the customer service will gladly assist you. |

1.2 Notational conventions

This manual uses the following notational conventions:

Letterings

The letterings for connectors and controls are marked by square brackets and italics.

Examples: *[VOLUME]* control, *[Mono]* button.

Displays

Texts and values displayed on the device are marked by quotation marks and italics.

Examples: *'24ch'*, *'OFF'*.

Instructions



The individual steps of an instruction are numbered consecutively. The result of a step is indented and highlighted by an arrow.

Example:

1. ▶ Switch on the device.
2. ▶ Press *[Auto]*.
 - ⇒ Automatic operation is started.
3. ▶ Switch off the device.

1.3 Symbols and signal words

In this section you will find an overview of the meaning of symbols and signal words that are used in this manual.

| Signal word | Meaning |
|---|--|
| DANGER! | This combination of symbol and signal word indicates an immediate dangerous situation that will result in death or serious injury if it is not avoided. |
| NOTICE! | This combination of symbol and signal word indicates a possible dangerous situation that can result in material and environmental damage if it is not avoided. |
| Warning signs | Type of danger |
|  | Warning – high-voltage. |
|  | Warning – danger zone. |

2 Safety instructions

Intended use

This appliance is designed for professional use only and is intended to be used to control the brightness of connected spotlights. Use the device only as described in this user manual. Any other use or use under other operating conditions is considered to be improper and may result in personal injury or property damage. No liability will be assumed for damages resulting from improper use.

This device may be used only by persons with sufficient physical, sensorial, and intellectual abilities and having corresponding knowledge and experience. Other persons may use this device only if they are supervised or instructed by a person who is responsible for their safety.

Safety



DANGER!

Danger for children

Ensure that plastic bags, packaging, etc. are disposed of properly and are not within reach of babies and young children. Choking hazard!

Ensure that children do not detach any small parts (e.g. knobs or the like) from the unit. They could swallow the pieces and choke!

Never let children unattended use electrical devices.



DANGER!

Electric shock caused by high voltages inside

Within the device there are areas where high voltages may be present. Never remove any covers.

There are no user-serviceable parts inside.

Do not use the device if covers, protectors or optical components are missing or damaged.



DANGER!

Hazardous voltage

Hazardous voltage may be present at cable ends and screw terminals.

The connection of screw terminals as well as all maintenance and repair work on the electrical installation of the device must only be performed by qualified electrical personnel in volt-free condition. Failure to do so may result in electric shock and risk of fire and loss of life.

By all means you have to observe all electrical safety instructions applicable at the place of operation.



NOTICE!

Risk of fire

Do not block areas of ventilation. Do not install the device near any direct heat source. Keep the device away from naked flames.



NOTICE!

Operating conditions

This device has been designed for indoor use only. To prevent damage, never expose the device to any liquid or moisture. Avoid direct sunlight, heavy dirt, and strong vibrations.

Only operate the device within the ambient conditions specified in the chapter 'Technical specifications' of this user manual. Avoid heavy temperature fluctuations and do not switch the device on immediately after it was exposed to temperature fluctuations (for example after transport at low outside temperatures).

Dust and dirt inside can damage the unit. When operated in harmful ambient conditions (dust, smoke, nicotine, fog, etc.), the unit should be maintained by qualified service personnel at regular intervals to prevent overheating and other malfunction.



NOTICE!

Power supply

Before connecting the device, ensure that the input voltage (AC outlet) matches the voltage rating of the device and that the AC outlet is protected by a residual current circuit breaker. Failure to do so could result in damage to the device and possibly injure the user.

Unplug the device before electrical storms occur and when it is unused for long periods of time to reduce the risk of electric shock or fire.

3 Features

General features

- 12 dimmer channels
- Outputs DPX-1210H NET (item # 469657): 2 × 16-pin multi-pin
Outputs DPX-1210S NET (item # 469658): 12 × safety sockets with hinged lid
- Control via DMX 512, ArtNET or manually via buttons and display on the unit
- Built-in DMX recorder for recording and storing of up to 99 static scenes
- Scenes can be played as a chase in a loop with adjustable fade time
- Live display for dimmer channel status
- Dimmer curve or switch mode adjustable per channel
- Silent mode for noise-sensitive environments

4 Installation and starting up

Unpack and check carefully there is no transportation damage before using the unit. Keep the equipment packaging. To fully protect the product against vibration, dust and moisture during transportation or storage use the original packaging or your own packaging material suitable for transport or storage, respectively.

Create all connections while the device is off. Use the shortest possible high-quality cables for all connections. Take care when running the cables to prevent tripping hazards.

The device is designed for mounting in 19" racks, it occupies two rack units (RU).

Connector

First, connect the loads to the terminals on the back of the device. Establish the DMX link to the controller. Finally, connect the power plug of the device to a 32 A CEE socket.

Connection options for blocks L1, L2 and L3:

- one block per phase
- one block to one phase, two blocks to a second phases
- all blocks to one phase



Regardless of the actual use, all three blocks should always be connected.

Connections in 'DMX' mode

Connect the DMX input of the device to the DMX output of a DMX controller or another DMX device. Connect the output of the first DMX device to the input of the second one and so on, to form a series connection. Make sure that the output of the last DMX device in the chain is terminated by a resistor (110 Ω , ¼ W).

5 Connections and controls

Front panel

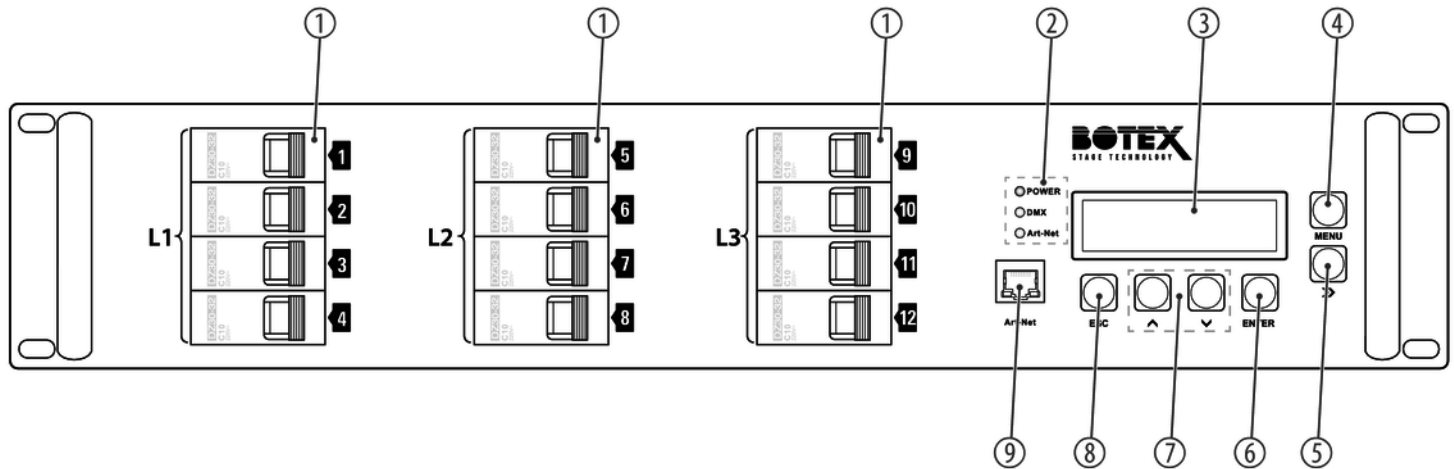

| | |
|---|--|
| 1 | <i>[1]...[12]</i> Circuit breakers for channels 1...12, arranged in three blocks (L1...L3). The required channels are activated or deactivated with the line circuit breakers. |
| 2 | <i>[POWER]</i> Power indicator. The LED lights up as soon as the unit is connected to the power supply. |
| | <i>[DMX]</i> Control indicator. The LED flashes when the device receives a DMX control signal. |
| | <i>[Art-Net]</i> Control indicator. The LED flashes when the device receives a Art-Net control signal. |
| 3 | Display |
| 4 | <i>[MENU]</i> Opens the main menu. |
| 5 | ▶▶ Toggles between the submenus. Moves the cursor to the right. |

| | |
|---|---|
| 6 | <i>[ENTER]</i> Confirms a selected value or opens a submenu. |
| 7 | ▼ Toggles between the menu items of a menu level, decreases the displayed value by one |
| | ▲ Toggles between the menu items of a menu level, increases the displayed value by one |
| 8 | <i>[ESC]</i> Closes an open menu without saving any changes. |
| 9 | <i>[Art-Net]</i> RJ45 input socket for network connection |

**Rear panel DPX-1210H NET
(item no. 469657)**

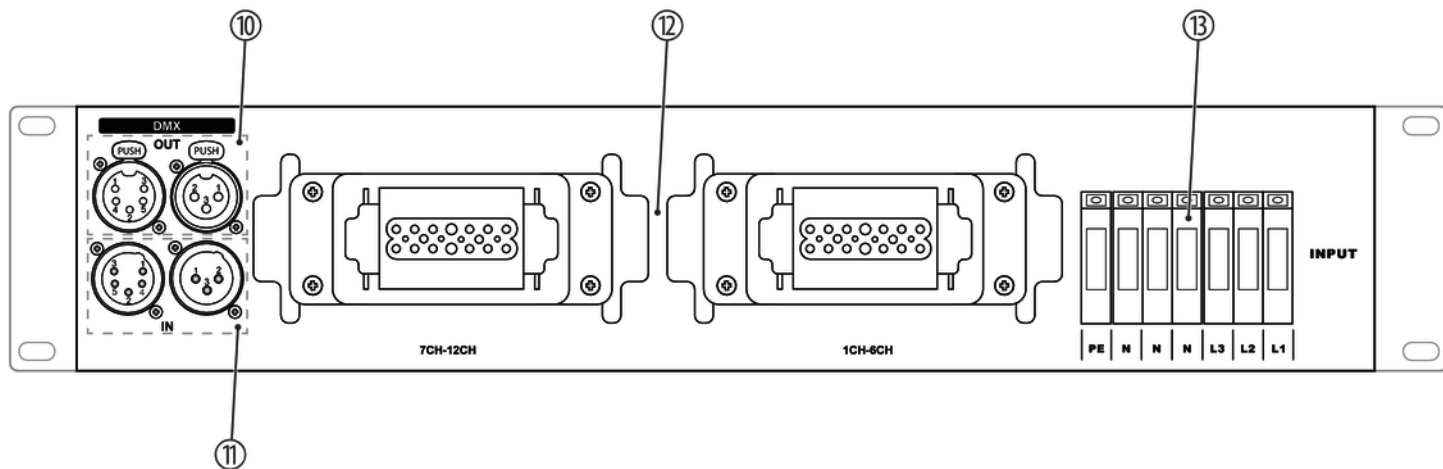

Rear panel DPX-1210S NET (item no. 469658)

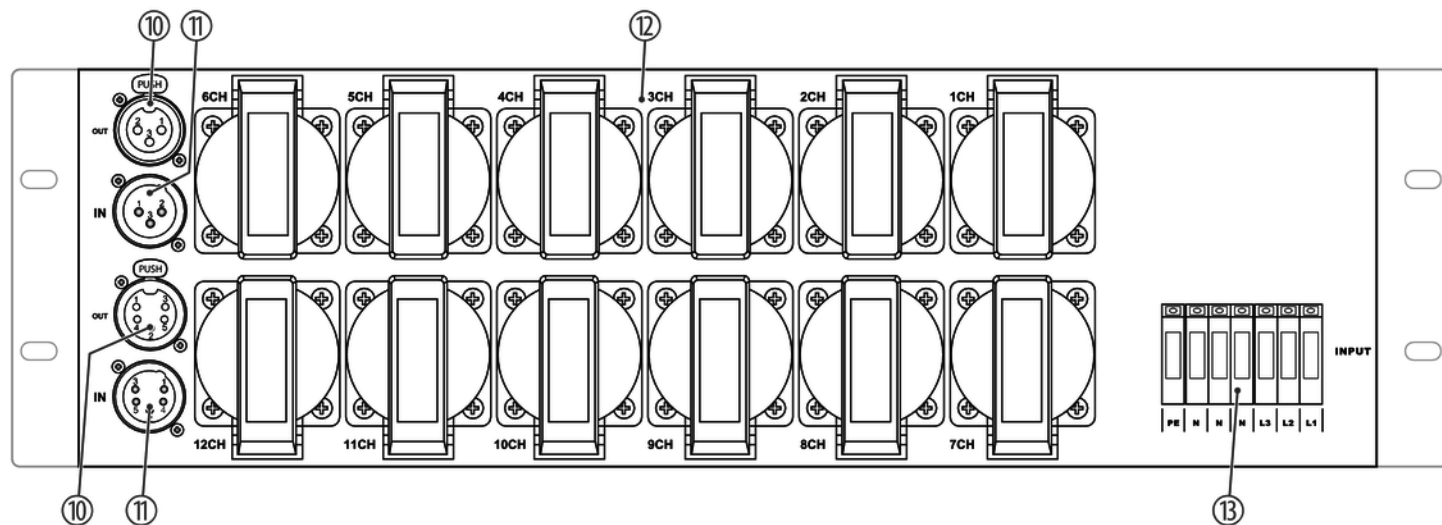

| | DPX-1210H NET (Item no. 469657) | DPX-1210S NET (Item no. 469658) |
|----|---|---|
| 10 | <i>[DMX OUT]</i> XLR output socket, 3-pin XLR output socket, 5-pin | <i>[DMX OUT]</i> XLR output socket, 3-pin XLR output socket, 5-pin |
| 11 | <i>[DMX IN]</i> DMX input socket, 3-pin DMX input socket, 5-pin | <i>[DMX IN]</i> DMX input socket, 3-pin DMX input socket, 5-pin |
| 12 | <i>[1CH...6CH], [7CH...12CH]</i> Dimmer outputs, 2 × 16-pin Harting industrial connectors (note the device label when connecting the cables). | <i>[1CH]...[12CH]</i> Dimmer outputs, 12 × safety sockets (note the device label when connecting the cables). |
| 13 | <i>[INPUT]</i> Mains connection terminals (note the device label when connecting the cables). | <i>[INPUT]</i> Mains connection terminals (note the device label when connecting the cables). |

6 Operating

Turning the device on / off

1. ➤ Connect the device to the power supply.
 - ⇒ The *[POWER]* LED lights up. The display shows '*Initialize...*' while the device is starting up. The start sequence is finished when the current device settings are shown on the display. The device is operational.
2. ➤ Switch on the required channels using the assigned circuit breakers.
3. ➤ To switch off the device, pull the mains plug from the 32 A CEE socket.

6.1 Main menu

1. ➤ Press *[MENU]* to activate the main menu.
2. ➤ Press ▼ or ▲ repeatedly until the desired submenu is shown on the display.
3. ➤ Press ►► to scroll through the various options of the submenu or to move the cursor to the right.

4. ▶ Press *[ENTER]* to activate a displayed sub menu.
5. ▶ Press *[ESC]* to exit the menu and return to display mode.

After 5 seconds of inactivity, the menu is closed and the device automatically returns to display mode.

In the '*LOCAL CONTROL*' and '*PLAY SCENE*' submenus, the menu remains open even after 5 seconds of inactivity.

6.2 DMX and Art-Net settings

Setting the DMX address

| Menu level 1 | Menu level 2 | Menu level 3 | Function |
|--------------|--------------|----------------------------|---|
| 'ADDRESS' | 'DMX-512A' | 'Start:001...512' | Sets the DMX start address. |
| | | 'Patch:01...12>>001...512' | Selects the channel for which the start address is being set. |
| | 'ArtNET' | 'SubNET:001...255' | Sets the ArtNET address for a SubNET. |
| | | 'Universe:001...255' | Sets the ArtNET address for an ArtNET universe. |

The DMX start address is set and assigned to a channel via the 'ADDRESS' menu.

1. ➤ Press [MENU] to activate the main menu.
2. ➤ Press ▼ or ▲ repeatedly until the 'ADDRESS' submenu is shown on the display.
3. ➤ Press ►► to select the 'DMX-512A' submenu and confirm with [ENTER].

4. ▶ Press *[ENTER]* to activate the Cursor.
5. ▶ Press ▼ or ▲ repeatedly until the display shows the desired DMX start address (display shows '001' ... '512') and confirm with *[ENTER]*.
 - ⇒ The value is confirmed. The parent menu level is displayed.
6. ▶ Press ▶▶ to select the 'Patch:' submenu for channel selection.
7. ▶ Press *[ENTER]* to activate the Cursor.
8. ▶ Press ▶▶ to move the cursor between the fields 'Patch:' for channel selection and 'Start:' for entering the start address.
9. ▶ Press ▼ or ▲ repeatedly until the display shows the desired channel (display shows '01' ... '12') or the desired start address (display shows '001' ... '512') and confirm with *[ENTER]*.
 - ⇒ The DMX start address is assigned to the selected channel.

Setting the Art-Net address

The ArtNET address is set via the 'ADDRESS' menu.

1. ➤ Press [MENU] to activate the main menu.
2. ➤ Press ▼ or ▲ repeatedly until the 'ADDRESS' submenu is shown on the display.
3. ➤ Press ►► to select the 'ArtNET' submenu and confirm with [ENTER].
4. ➤ Press ►► to select the 'SubNET:' submenu for a subnet or the 'Universe' submenu for an ArtNET universe and confirm with [ENTER].
5. ➤ Press ▼ or ▲ repeatedly until the display shows the desired address for the subnet or the Art-Net universe (display shows '000' ... '255') and confirm with [ENTER].
⇒ The ArtNET address is assigned to the selected SubNET or ArtNET universe.

6.3 Dimmer settings

Setting parameters of the dimmer channel

The parameters of the selected dimmer channel are set via the 'LOCAL CONTROL' menu.

1. ➤ Press *[MENU]* to activate the main menu.
2. ➤ Press ▼ or ▲ repeatedly until the 'LOCAL CONTROL' submenu appears on the display and activate the submenu with *[ENTER]*.
⇒ The set dimmer channel flashes.
3. ➤ Press ►► to move the cursor to the number of the dimmer channel (display shows 'LIVE 123456789012') whose parameters you want to change.
4. ➤ Press ▼ or ▲ repeatedly until the display shows the desired value for the selected dimmer channel.
5. ➤ Press *[ESC]* to exit the menu and return to display mode.
⇒ The set value is applied.

Setting the dimmer curve

| Menu level 1 | Menu level 2 | Function |
|--------------|--------------|---|
| 'CURVES' | 'Linear' | A linear dimmer curve is set. |
| | 'Square' | A square dimmer curve is set. |
| | 'NO-DIM' | Switch mode is activated. The output power is 0% or 100%. |

The dimmer curve for individual or all channels is set via the 'CURVES' menu.

1. ▶ Press [MENU] to activate the main menu.
2. ▶ Press ▼ or ▲ repeatedly until the 'CURVES' submenu appears on the display and confirm with [ENTER].
 - ⇒ The cursor flashes at channel one.
3. ▶ Press ►► to move the cursor to the desired channel.
4. ▶ Press ▼ or ▲ repeatedly until the display shows the desired dimmer curve (display shows 'Linear', 'Square' or 'NO-DIM') and confirm with [ENTER].
5. ▶ To exit the menu without making changes, press [ESC].

6.4 Scenes

Saving a scene

| Menu level 1 | Menu level 2 | Function |
|--------------|--------------|---|
| 'SCENE REC' | 'Copy' | Saves a scene under a number from 01 to 99. |
| | 'Assign' | Assigns a saved scene to a channel. |

Scenes are saved via the 'SCENE REC/copy' menu.

1. ➤ Press [MENU] to activate the main menu.
2. ➤ Press ▼ or ▲ repeatedly until the 'SCENE REC' submenu is shown on the display.
3. ➤ Press ►► to select the 'Copy' submenu and confirm with [ENTER].
4. ➤ Press ▼ or ▲ repeatedly until the display shows the number under which you want to save the scene (display shows '01' ... '99').

Scenes 71...99 are preset sample scenes. You can modify or overwrite them.

5. ➤ Press ►► to move the cursor to 'ENTER'.

⇒ The 'ENTER' display flashes.

6. ➤ Press *[ENTER]*.

⇒ The incoming DMX signal is saved as a scene under the set number. At the end of the saving process, the scene numbering display automatically jumps to the next higher number.

Setting a scene manually

Scenes can be created and saved manually using the '*SCENE REC/Assign*' menu.

1. ➤ Press *[MENU]* to activate the main menu.

2. ➤ Press ▼ or ▲ repeatedly until the '*SCENE REC*' submenu is shown on the display.

3. ➤ Press ►► to select the '*Assign*' submenu and confirm with *[ENTER]*.

4. ➤ Press ►► to move the cursor to the number of the channel whose value you want to change.

5. ➤ Press ▼ or ▲ to set the dimmer value of the channels of the selected scene (display "01" ... '99' / 'FL').

6. ➤ Press *[ENTER]*.









⇒ The set values are adopted. The display automatically jumps to the next scene.

7. ➤ To exit the menu without making changes, press *[ESC]*.

Playing a Chase



| Menu level 1 | Menu level 2 | Menu level 3 | Function |
|--------------|--------------|----------------------|---|
| 'PLAY SCENE' | 'Chase' | 'Once' | Plays the selected scene once. |
| | | 'Loop' | Plays the selected scene in an endless loop. |
| | | 'Fad1s...Fad9s' | Sets the fade time from 1 to 9 seconds. |
| | | 'E01...E99' | Selects the final scene 01 to 99. |
| | | | Playback pauses. |
| | > | Playback is running. | |
| | 'Scene' | 'Sc01' ... 'Sc99' | Selects the start scene. Plays a selected single scene on the set channel. |

Chases are played via the '*PLAY SCENE/Chase*' menu.

1.  Press *[MENU]* to activate the main menu.
2.  Press *▼* or *▲* repeatedly until the '*PLAY SCENE*' submenu is shown on the display.
3.  Press *▶▶* to select the '*Chase*' submenu and confirm with *[ENTER]*.
4.  Press *▼* or *▲* until the display shows the number of the scene with which the chase should start (display shows '*01*' ... '*99*').
5.  Press *▶▶* to move the cursor to the display mode options.
6.  Press *▼* or *▲* to select the play mode '*Once*' (single play) or '*Loop*' (loop playback).
7.  Press *▶▶* and then press *▼* or *▲* to select the fade time '*Fad1s...Fad9s*'.
8.  Press *▶▶* and then press *▼* or *▲* to select the closing scene '*E01...E99*'.
9.  Press *[ENTER]* to pause the chase (display *|*) or play (display *>*).

Playing a scene

Individual scenes are played via the '*PLAY SCENE/Scene*' menu.

1.  Press *[MENU]* to activate the main menu.
2.  Press *▼* or *▲* repeatedly until the '*PLAY SCENE*' submenu is shown on the display.

3. ➤ Press ►► to select the 'Scene' submenu and confirm with [ENTER].
4. ➤ Press ▼ or ▲ to select the desired single scene (display shows 'Sc01' ... 'Sc99').
5. ➤ Press [ENTER].
 - ⇒ The selected scene is played on the set channel.
6. ➤ To exit the menu without making changes, press [ESC].

6.5 General Settings

| Menu level 1 | Menu level 2 | Menu level 3 | Function |
|--------------|-------------------|--------------|--|
| 'SETUP' | 'Protocol Assign' | 'D' | The control protocol DMX is selected. |
| | | 'A' | The control protocol ArtNet is selected. |

| Menu level 1 | Menu level 2 | Menu level 3 | Function |
|--------------|-----------------|-------------------|---|
| | 'ArtNET Failed' | 'Off' | The device is blacked out. |
| | | 'Hold' | The last setting is retained. |
| | | 'Off After 10min' | The device is blacked out after 10 minutes. |
| | | 'ArtNet fail DMX' | The control protocol DMX gets activated. |
| | | 'GoScene##' | The scene selected in this setting is played. |
| | 'DMX Failed' | 'Off' | The device is blacked out. |
| | | 'Hold' | The last setting is retained. |
| | | | |

| Menu level 1 | Menu level 2 | Menu level 3 | Function |
|--------------|---------------|-------------------|--|
| | | 'Off After 10min' | The device is blacked out after 10 minutes. |
| | | 'DMX fail ArtNet' | The control protocol ArtNET gets activated. |
| | | 'GoScene##' | The scene selected in this setting is played. |
| | 'Fan Cooling' | 'Normal' | The fan runs in 'Normal' mode. The device is kept at a maximum temperature of 70° C. |

| Menu level 1 | Menu level 2 | Menu level 3 | Function |
|--------------|--------------|--------------|---|
| | | 'Silent' | The fan runs in 'Silent' mode. The fan runs slower than in normal mode. The device is kept at a maximum temperature of 90° C. |
| | | 'Full On' | The fan runs at maximum speed. |
| | 'Default' | 'Confirm' | Resets the device to factory defaults. |

Selecting a control protocol

The control protocol is selected via the '*SETUP/Protocol Assign*' menu.

1. ➤ Press *[MENU]* to activate the main menu.
2. ➤ Press ▼ or ▲ repeatedly until the '*SETUP*' submenu is shown on the display.
3. ➤ Press ►► to select the '*Protocol Assign*' submenu and confirm with *[ENTER]*.

4. ➤ Press ►► to move the cursor to the number of the channel to which you want to assign the control protocol.
5. ➤ Press ▼ or ▲ to select either 'D' (DMX) or 'A' (ArtNET) and confirm with [ENTER].
⇒ The control protocol for the selected channel is set.

Setting the behaviour on ArtNet signal failure

The '*SETUP/ArtNET Failed*' menu is used to set how the device reacts when the ArtNET signal fails.

1. ➤ Press [MENU] to activate the main menu.
2. ➤ Press ▼ or ▲ repeatedly until the '*SETUP*' submenu is shown on the display.
3. ➤ Press ►► to select the '*ArtNET Failed*' submenu and confirm with [ENTER].
4. ➤ Press ▼ or ▲ to select the desired option for the behaviour of the device in the event of ArtNET control failure.
5. ➤ If you have chosen the '*GoScene##*' option, press ►► to activate the cursor and use ▼ or ▲ to select a scene between 01 and 99.
6. ➤ Press [ENTER] to confirm the selection.
⇒ The selected settings are adopted.

Setting the behaviour on DMX signal failure

7. ➤ To exit the menu without making changes, press *[ESC]*.

The '*SETUP/DMX Failed*' menu is used to set how the device reacts when the DMX signal fails.

1. ➤ Press *[MENU]* to activate the main menu.

2. ➤ Press ▼ or ▲ repeatedly until the '*SETUP*' submenu is shown on the display.

3. ➤ Press ►► to select the '*DMX Failed*' submenu and confirm with *[ENTER]*.

4. ➤ Press ▼ or ▲ to select the desired option for the behaviour of the device in the event of ArtNET control failure.

5. ➤ If you have chosen the '*GoScene##*' option, press ►► to activate the cursor and use ▼ or ▲ to select a scene between 01 and 99.

6. ➤ Press *[ENTER]* to confirm the selection.

⇒ The selected settings are adopted.

7. ➤ To exit the menu without making changes, press *[ESC]*.

Fan settings

The '*SETUP/Fan Cooling*' menu is used to adjust the fan.

1. ➤ Press *[MENU]* to activate the main menu.
2. ➤ Press ▼ or ▲ repeatedly until the '*SETUP*' submenu is shown on the display.
3. ➤ Press ►► to select the '*Fan Cooling*' submenu and confirm with *[ENTER]*.
4. ➤ Press ▼ or ▲ to select the desired option for the behaviour of the fan (display shows '*Normal*', '*Silent*', '*Full On*').
5. ➤ Press *[ENTER]* to confirm the selection.
⇒ The selected settings are adopted.
6. ➤ To exit the menu without making changes, press *[ESC]*.

Reset to factory defaults

The '*SETUP/Factory Default*' menu is used to reset the device to factory defaults.

1. ➤ Press *[MENU]* to activate the main menu.
2. ➤ Press ▼ or ▲ repeatedly until the '*SETUP*' submenu is shown on the display.
3. ➤ Press ►► to select the '*Factory Default*' submenu and confirm with *[ENTER]*.
⇒ The display shows '*Confirm*'.

4. ➤ Press *[ENTER]* to confirm the selection.
 - ⇒ The device is reset to factory default settings.
5. ➤ To exit the menu without making changes, press *[ESC]*.

6.6 System information

| Menu level 1 | Menu level 2 | Function |
|---------------|--------------------|---|
| 'INFORMATION' | 'Software Version' | Indicates the software version used. |
| | 'Temperature' | Displays the device temperature for dimmer channels 1 to 6 and 7 to 12. |

The 'INFORMATION' menu is used to call up system information.

1. ➤ Press *[MENU]* to activate the main menu.
2. ➤ Press ▼ or ▲ repeatedly until the 'INFORMATION' submenu is shown on the display.

- 3.** ▶ Press ▶▶ to select the *'Software Version'* submenu and confirm with [ENTER].
 - ⇒ The current software version of the device is displayed.
- 4.** ▶ Press ▶▶ to select the *'Temperature'* submenu and confirm with [ENTER].
 - ⇒ The device temperature for dimmers 1 to 6 (display shows 'L=') and dimmer 7 to 12 (display shows 'R=').
- 5.** ▶ To exit the menu, press [ESC].

7 Technical specifications

| | | DPX-1210H NET (Item no. 469657) | DPX-1210S NET (Item no. 469658) |
|--------------------|----------------|---|--|
| Control principle | | Leading edge phase control | |
| Input connections | Voltage supply | Terminals (3-phase connection, 400 V, 32 A max. per phase) | |
| | Signal input | 1 × DMX 512 via 3-pin XLR socket | |
| | | 1 × DMX 512 via 5-pin XLR socket | |
| | | 1 × Art-Net via RJ45 socket | |
| Output connections | Voltage supply | 2 × Harting industrial connectors, 16-pin | 12 × safety sockets with hinged lid |
| | Signal output | 1 × DMX 512 via 3-pin XLR socket | |
| | | 1 × DMX 512 via 5-pin XLR socket | |
| Channel fuse | Single-phase | 1 × circuit breaker per channel, each 10 A, 96 A max. | |

Technical specifications

| | | DPX-1210H NET (Item no. 469657) | DPX-1210S NET (Item no. 469658) |
|--------------------------|-------------------|---|--|
| Operating supply voltage | Three-phase | 1 × circuit breaker per channel, each 10 A, 32 A max. | |
| | Single-phase | 230 V ~ 50 Hz | |
| | Three-phase | 400 V ~ 50 Hz | |
| Output power | | 10 A/channel, 2.3 kW | |
| Protection class | | IP20 | |
| Mounting properties | | 19 inch, 2 RU | 19 inch, 2 RU |
| | | Installation depth 380 mm | Installation depth 360 mm |
| Dimensions (W × H × D) | | 482 mm × 89 mm × 379 mm | 483 mm × 133 mm × 377 mm |
| Weight | | 15 kg | |
| Ambient conditions | Temperature range | 0 °C...40 °C | |
| | Relative humidity | 50 %, non-condensing | |

Further information

| | DPX-1210H NET (Item no. 469657) | DPX-1210S NET (Item no. 469658) |
|-----------------|--|--|
| Dimmer channels | 12 | 12 |
| Output | 16-pin multi-pin | Safety socket |

8 Plug and connection assignment

Introduction

This chapter will help you select the right cables and plugs to connect your valuable equipment so that a perfect light experience is guaranteed.

Please take our tips, because especially in 'Sound & Light' caution is indicated: Even if a plug fits into a socket, the result of an incorrect connection may be a destroyed DMX controller, a short circuit or 'just' a not working light show!

DMX connections



Three- and five-pin XLR sockets serve as DMX outputs, a three- or five-pin XLR connector (optionally) serves as DMX input. The figure below and the table show the pin assignment.

| Pin | 5-pin | 3-pin |
|-----|-----------------------------------|--------------------------------|
| 1 | Ground (shielding) | Ground (shielding) |
| 2 | Signal inverted (DMX-, 'cold') | Signal inverted (DMX-, 'cold') |
| 3 | Signal (DMX+, 'hot') | Signal (DMX+, 'hot') |
| 4 | unused / second connection (DMX-) | |
| 5 | unused / second connection (DMX+) | |

9 Protecting the environment

Disposal of the packaging material



For the transport and protective packaging, environmentally friendly materials have been chosen that can be supplied to normal recycling.

Ensure that plastic bags, packaging, etc. are properly disposed of.

Do not just dispose of these materials with your normal household waste, but make sure that they are collected for recycling. Please follow the notes and markings on the packaging.

Disposal of your old device



This product is subject to the European Waste Electrical and Electronic Equipment Directive (WEEE) in its currently valid version. Do not dispose with your normal household waste.

Dispose of this device through an approved waste disposal firm or through your local waste facility. When discarding the device, comply with the rules and regulations that apply in your country. If in doubt, consult your local waste disposal facility.

