

th•mann

DP-32 B, DP-32 WH
digital piano



Musikhaus Thomann
Thomann GmbH
Hans-Thomann-Straße 1
96138 Burgebrach
Germany
Telephone: +49 (0) 9546 9223-0
E-mail: info@thomann.de
Internet: www.thomann.de

16.10.2019, ID: 448686, 448687 (V2)

Table of contents

1	General information	5
	1.1 Further information.....	5
	1.2 Notational conventions.....	5
	1.3 Symbols and signal words.....	6
2	Safety instructions	7
3	Features	9
4	Assembly instructions	10
5	Connections and operating elements	14
6	Connection options	17
7	Turning the digital piano on / off, setup	19
	7.1 Switching the digital piano on.....	19
	7.2 Automatic shutoff.....	19
	7.3 Adjusting the volume.....	19
	7.4 Touch sensitivity.....	20
	7.5 Transposing.....	21
	7.6 Fine tuning.....	21
	7.7 Metronome.....	22
	7.8 Tempo.....	23
	7.9 Button sound.....	24
	7.10 Pedal resonance.....	24
8	Operating	25
	8.1 Demo song.....	25
	8.2 Practising songs.....	25
	8.2.1 Selecting practise songs.....	25
	8.2.2 Practising left and / or right hand.....	26
	8.3 Voices.....	27
	8.3.1 Selecting voices.....	27
	8.3.2 Split mode.....	27
	8.3.3 Dual mode.....	28
	8.3.4 Demo mode.....	29
	8.3.5 Duet mode.....	29
	8.3.6 TWINOVA.....	30
	8.4 Digital effects.....	31
	8.4.1 Chorus effect.....	31
	8.4.2 Reverb effect.....	32
	8.4.3 Dynamic Acoustic System (DAS).....	32
	8.5 Recording function.....	33
	8.5.1 Preparing and starting recording.....	33
	8.5.2 Stopping recording.....	33
	8.5.3 Playing a recording.....	34
	8.5.4 Deleting recordings.....	34

8.6	MIDI functions.....	35
8.6.1	USB connection to a computer.....	35
8.6.2	Setting the MIDI channel.....	35
9	Practise and demo songs.....	36
10	Voice list.....	38
11	MIDI implementation chart.....	39
12	Troubleshooting.....	41
13	Technical specifications.....	42
14	Plug and connection assignment.....	44
15	Protecting the environment.....	45

1 General information

This user manual contains important information on the safe operation of the device. Read and follow all safety notes and all instructions. Save this manual for future reference. Make sure that it is available to all persons using this device. If you sell the device to another user, be sure that they also receive this manual.

Our products and user manuals are subject to a process of continuous development. We therefore reserve the right to make changes without notice. Please refer to the latest version of the user manual which is ready for download under www.thomann.de.

1.1 Further information

On our website (www.thomann.de) you will find lots of further information and details on the following points:

Download	This manual is also available as PDF file for you to download.
Keyword search	Use the search function in the electronic version to find the topics of interest for you quickly.
Online guides	Our online guides provide detailed information on technical basics and terms.
Personal consultation	For personal consultation please contact our technical hotline.
Service	If you have any problems with the device the customer service will gladly assist you.

1.2 Notational conventions

This manual uses the following notational conventions:

Letterings

The letterings for connectors and controls are marked by square brackets and italics.

Examples: *[VOLUME]* control, *[Mono]* button.

Displays

Texts and values displayed on the device are marked by quotation marks and italics.

Examples: '24ch', 'OFF'.

Instructions

The individual steps of an instruction are numbered consecutively. The result of a step is indented and highlighted by an arrow.

Example:

1. ➤ Switch on the device.
2. ➤ Press [Auto].
⇒ Automatic operation is started.
3. ➤ Switch off the device.



Cross-references

References to other locations in this manual are identified by an arrow and the specified page number. In the electronic version of the manual, you can click the cross-reference to jump to the specified location.

Example: See ➤ 'Cross-references' on page 6.

1.3 Symbols and signal words

In this section you will find an overview of the meaning of symbols and signal words that are used in this manual.

Signal word	Meaning
DANGER!	This combination of symbol and signal word indicates an immediate dangerous situation that will result in death or serious injury if it is not avoided.
CAUTION!	This combination of symbol and signal word indicates a possible dangerous situation that can result in minor injury if it is not avoided.
NOTICE!	This combination of symbol and signal word indicates a possible dangerous situation that can result in material and environmental damage if it is not avoided.
Warning signs	Type of danger
	Warning – high-voltage.
	Warning – danger zone.

2 Safety instructions

Intended use

This device is intended to be used for electronic sound generation using a piano keyboard. Use the device only as described in this user manual. Any other use or use under other operating conditions is considered to be improper and may result in personal injury or property damage. No liability will be assumed for damages resulting from improper use.

This device may be used only by persons with sufficient physical, sensorial, and intellectual abilities and having corresponding knowledge and experience. Other persons may use this device only if they are supervised or instructed by a person who is responsible for their safety.

Safety

**DANGER!****Danger for children**

Ensure that plastic bags, packaging, etc. are disposed of properly and are not within reach of babies and young children. Choking hazard!

Ensure that children do not detach any small parts (e.g. knobs or the like) from the unit. They could swallow the pieces and choke!

Never let children unattended use electrical devices.

**DANGER!****Electric shock caused by short-circuit**

Always use proper ready-made insulated two-wire mains cabling (power cord). Do not modify the mains cable or the plug. Failure to do so could result in electric shock/death or fire. If in doubt, seek advice from a registered electrician.

**DANGER!****Electric shock caused by high voltages inside**

Within the device there are areas where high voltages may be present. Never remove any covers.

There are no user-serviceable parts inside.

Do not use the device if covers, protectors or optical components are missing or damaged.

**CAUTION!****Possible hearing damage**

With loudspeakers or headphones connected, the device can produce volume levels that may cause temporary or permanent hearing impairment.

Do not operate the device permanently at a high volume level. Decrease the volume level immediately if you experience ringing in your ears or hearing impairment.

**CAUTION!****Risk of injury due to heavy weight**

Due to the heavy weight of the device, at least two persons are required for transport and installation.

**NOTICE!****Operating conditions**

This device has been designed for indoor use only. To prevent damage, never expose the device to any liquid or moisture. Avoid direct sunlight, heavy dirt, and strong vibrations.

Only operate the device within the ambient conditions specified in the chapter 'Technical specifications' of this user manual. Avoid heavy temperature fluctuations and do not switch the device on immediately after it was exposed to temperature fluctuations (for example after transport at low outside temperatures).

Dust and dirt inside can damage the unit. When operated in harmful ambient conditions (dust, smoke, nicotine, fog, etc.), the unit should be maintained by qualified service personnel at regular intervals to prevent overheating and other malfunction.

**NOTICE!****Power supply**

Before connecting the device, ensure that the input voltage (AC outlet) matches the voltage rating of the device and that the AC outlet is protected by a residual current circuit breaker. Failure to do so could result in damage to the device and possibly injure the user.

Unplug the device before electrical storms occur and when it is unused for long periods of time to reduce the risk of electric shock or fire.

3 Features

The digital piano is characterized by the following features:

- Keyboard: 88 weighted keys with hammer action and adjustable touch response.
- 16 sounds
- 128-voice polyphony
- Reverb
- Chorus
- Split mode
- Metronome
- Transpose function
- Music Library with 60 rehearsal songs
- Speaker: 2 × 10 W
- 3 pedals
- Connections: 2 × headphones out, stereo AUX IN/OUT, USB MIDI 2.0
- Finish: matt black (item # 448686) or matt white (item # 448687)
- Automatic shutoff

4 Assembly instructions

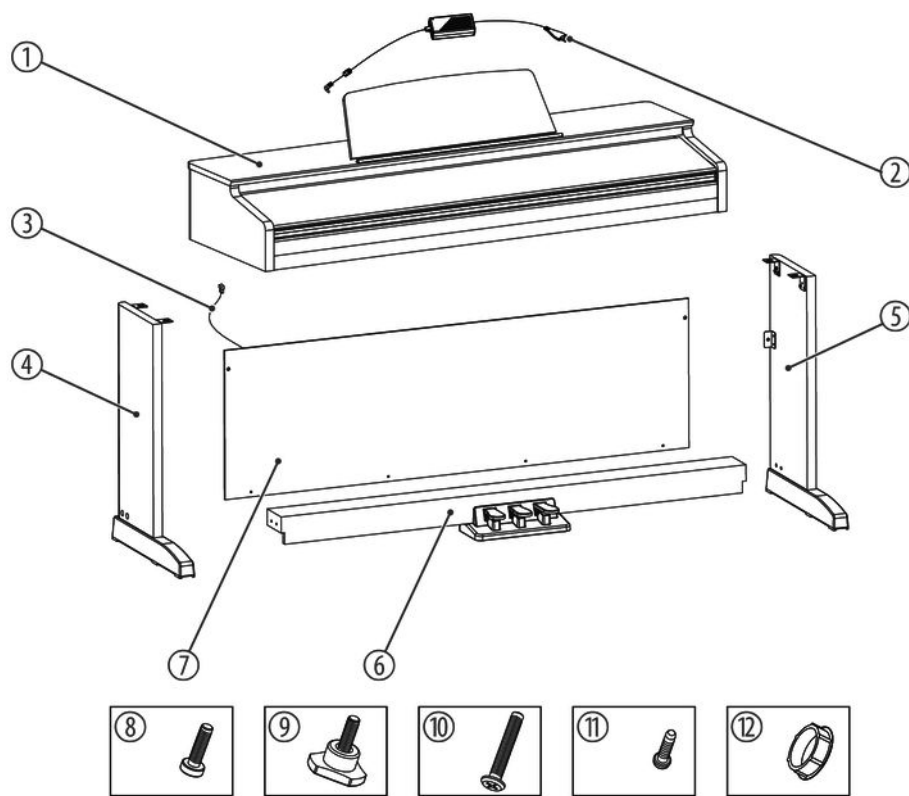

You need a Phillips screwdriver (not supplied) for the assembly of the digital piano. Open the package and make sure before assembling that the entire scope of delivery is present, as posted here.

1	Digital piano housing	7	Back panel
2	Power cord	8	Phillips-head screws M6 × 18 (2 pcs.)
3	Pedal cable	9	Hand screws (4 pcs.)
4	Left side panel	10	Phillips-head screws 6 × 50 (4 pcs.)
5	Right side panel	11	Phillips-head screws 4 × 15 (4 pcs.)
6	Pedal box	12	Plastic caps (4 pcs.)

Mechanical assembly

Proceed according to the illustrations and only use the supplied screws. Using other screws could damage the piano housing or result in a reduced stability of the piano.

- Hand screws (4 pcs.)
- Phillips-head screws M6 × 18 (8 pcs.)
- Phillips-head screws 6 × 50 (4 pcs.)
- Phillips-head screws 4 × 15 (4 pcs.)
- Plastic caps (4 pcs.)

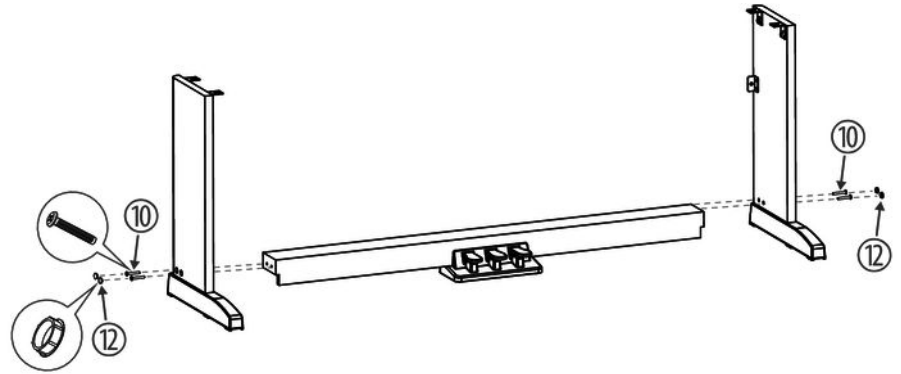

Put the pedal box between the left and right side panel and use two screws 6 × 50 on each side to affix both side panels to the pedal box. Attach the four plastic caps.

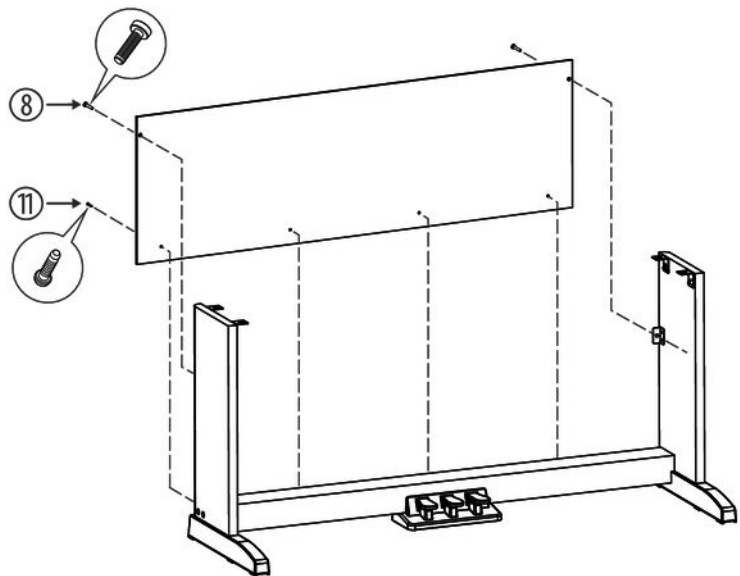

Attach the rear panel to the pedal box with four screws 4 × 15 and with two screws M6 × 18 to the mounting brackets of the side panels.

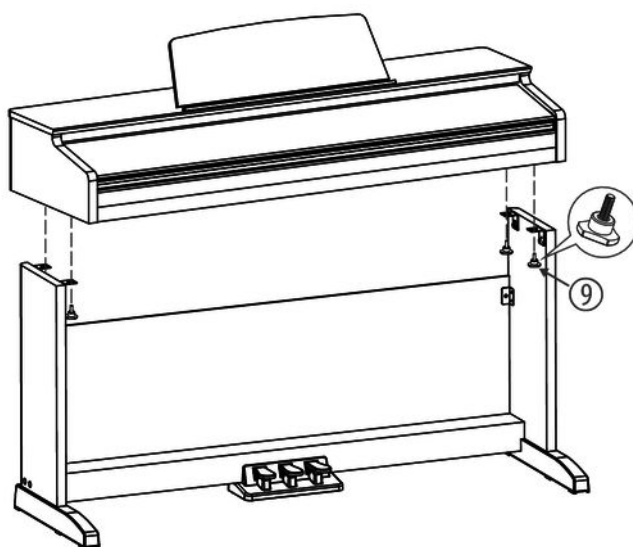

Put the digital piano housing on the stand and affix it using four hand screws.

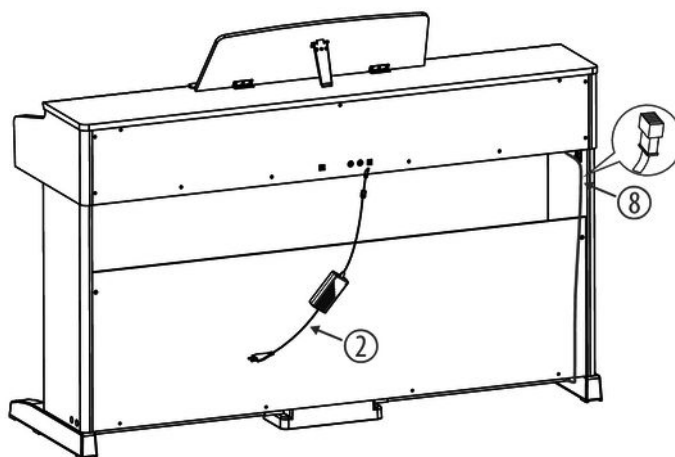

Connect the DIN plug of the pedal cable to the provided socket on the bottom side of the digital piano housing. Fix the cable to the base and move the digital piano to the desired position.

Connecting the power supply

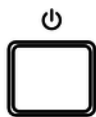

Make sure that the device is turned off before you connect it to the power supply or disconnect it.

VOLUME

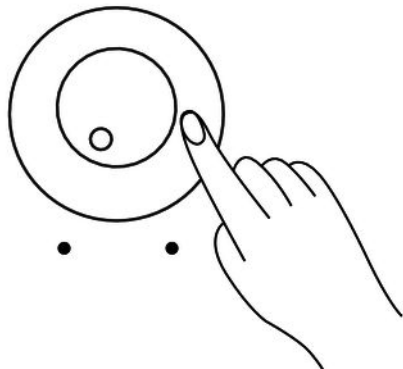

Turn the volume knob counter-clockwise to minimum before connecting the digital piano to the power supply or to other devices. This is to protect the speakers from damage.

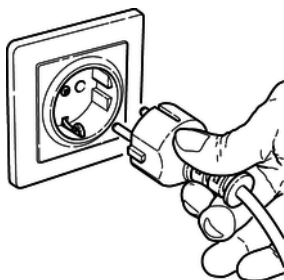

Connect the cable from the power adapter outlet to the input socket [DC IN] on the rear panel of the digital piano.

Plug the AC power cord into a properly wired mains wall outlet.

5 Connections and operating elements

Control panel left and right

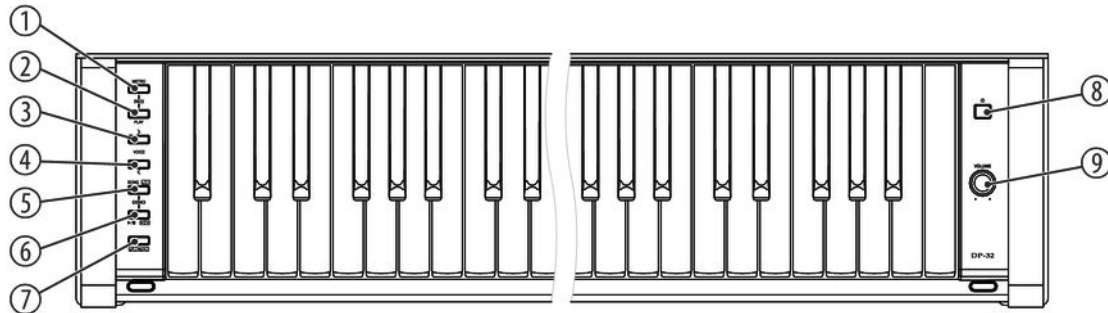

1	<i>[METRO]</i> Button to turn the metronome on and off Press <i>[METRO]</i> and <i>[PLAY]</i> simultaneously to enable the recording mode.
2	<i>[PLAY]</i> Button to start and stop user song playback Press <i>[METRO]</i> and <i>[PLAY]</i> simultaneously to enable the recording mode.
3, 4	< / > Buttons to set the parameters
5	<i>[SONG/RVB]</i> Button for selecting practise pieces
6	▶/■/ <i>[CHO]</i> Button to start and stop the practice pieces
7	<i>[FUNCTION]</i> Press and hold this key while you call up a specific function with a piano key.
8	⏻ Turns the digital piano on and off
9	<i>[VOLUME]</i> Rotary volume control

Pedals

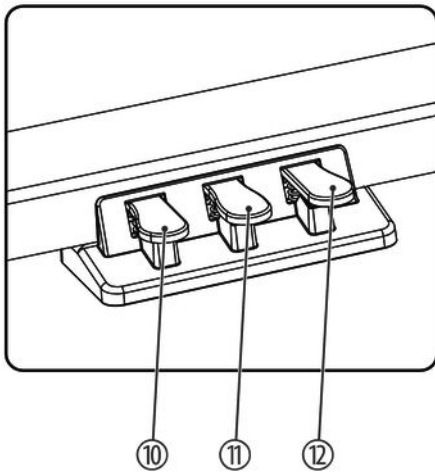

- 10 Soft pedal
Using the Soft pedal makes the piano sound smoother and the overall volume is attenuated.
- 11 Sostenuto pedal
When stepping on the Sostenuto pedal, the currently played notes linger until you release the pedal.
- 12 Sustain pedal
With the sustain pedal all played notes sound longer. This effect simulates the lifting of the damper in an analogue keyboard instrument.

Rear panel connections

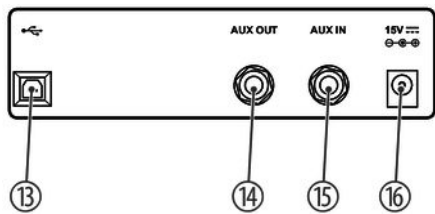

- 13 USB/MIDI interface to connect a computer
- 14 [AUX OUT]
Output for external audio devices like active speakers or amplifiers
- 15 [AUX IN]
Connection for external audio devices such as MP3 or CD players to use the internal speakers
- 16 [DC IN]
Connection for the power adapter

Piano keys

The keyboard keys are referred to in this manual as shown below.

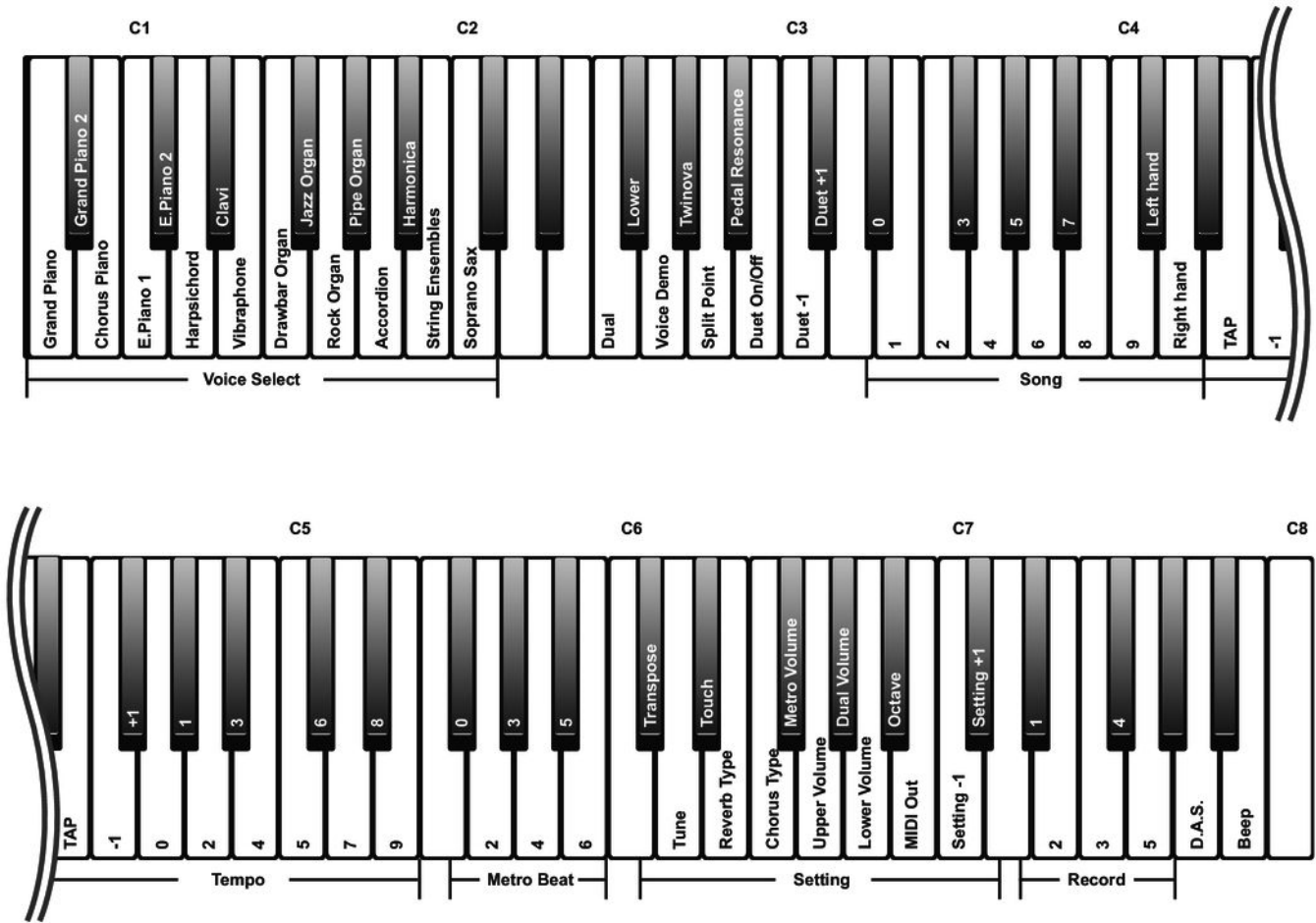

6 Connection options

Headphones

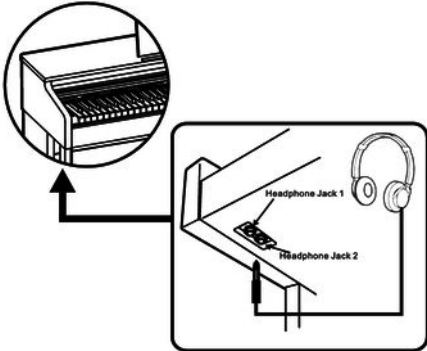

To the left beneath the keyboard you find the headphones outlets 1 and 2 (designed as 1/4" phone socket).

If you connect headphones (not supplied) to output 1, speaker playback will be retained.

Using outlet 2 mutes the speakers.

External audio devices via the AUX OUT socket

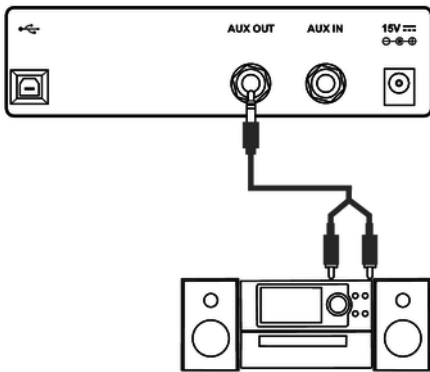

Use the AUX OUT socket to connect the digital piano to an amplifier, stereo device, mixing console or recording device. Plug one end of the audio cable into the AUX OUT socket on the rear panel of the digital piano and the other end into the input of the respective audio device.



NOTICE!

To prevent damage to the speakers, turn the volume down to 'Minimum' before you connect other devices to the digital piano.

External audio devices via the AUX IN socket

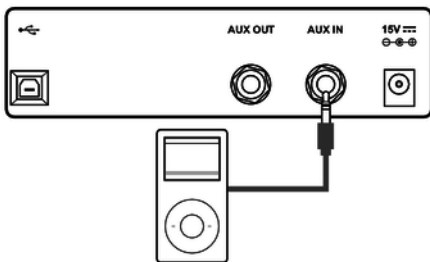

Use the AUX IN socket to connect a, for example, CD or MP3 player to the digital piano. So you can playback music through the internal speakers of the digital piano and simultaneously play along to it. Plug one end of the audio cable into the AUX IN socket on the rear panel of the digital piano and the other end into the output of the respective audio device.

Computer via USB

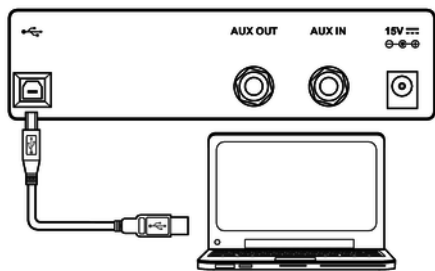

You can connect the digital piano to exchange data with a PC via the USB port. This also allows the transfer of MIDI data.



NOTICE!

The digital piano supports the computer operating systems Windows 7, Windows 8, Windows 10, Mac OS X and higher.

Update the operating system of your computer if necessary.



NOTICE!

Do not set the USB interface as the in and output at the same time in the computer software. Otherwise, there will be overlap when playing the digital piano.

7 Turning the digital piano on / off, setup

7.1 Switching the digital piano on

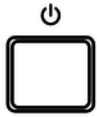

Press the power button on the right of the claviature to turn the digital piano on or off.



If you hear nothing coming from the speakers, the volume may be set to 'minimum'.

7.2 Automatic shutoff

When the digital piano is not being used for 30 minutes, it switches off automatically. To turn it on again, press the power button on the unit.

The automatic shutoff is activated automatically when powering up the digital piano. To deactivate the automatic shutoff function, press the first white key on the left while the digital piano is being switched on.

7.3 Adjusting the volume

VOLUME

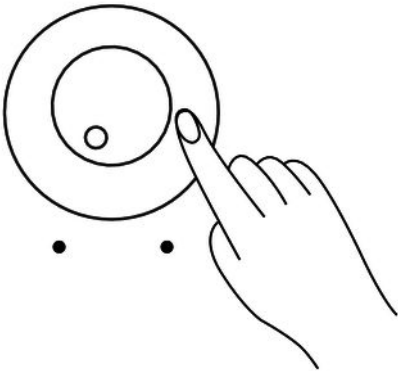

Adjust the rotary control [VOLUME] for a pleasant volume for playback and practising. Turn this control clockwise to increase the volume. Turn it counter-clockwise to reduce volume.



If you hear nothing coming from the speakers, the volume may be set to 'minimum' or headphones are connected to outlet 2.

7.4 Touch sensitivity

With this function you can adjust the touch response of the keyboard at six different levels.

Parameter	Meaning
[OFF]	Touch sensitivity is off. This can be very recommendable when playing the organ voice.
[1]	Hard 2 In this setting, the volume is lower than usual even when playing with a hard touch.
[2]	Hard 1 In this setting, the volume is slightly lower than usual even when playing with a hard touch.
[3]	Normal This setting corresponds to the usual touch response of a keyboard.
[4]	Soft 1 In this setting, the volume is slightly higher than usual even when playing with a soft touch.
[5]	Soft 2 In this setting, the volume is higher than usual even when playing with a soft touch.

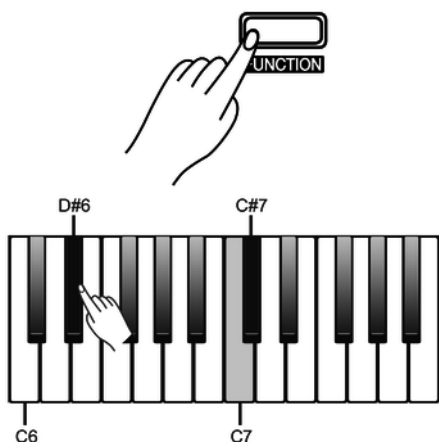

1. ➤ Hold down the [FUNCTION] button and press piano key [D#6].
2. ➤ Hold down the [FUNCTION] button and press piano key [C7] or [C#7] to adjust the touch sensitivity.



– Hold down the [FUNCTION] button and press piano key [C7] and [C#7] simultaneously to restore the preset value '3'.

7.5 Transposing

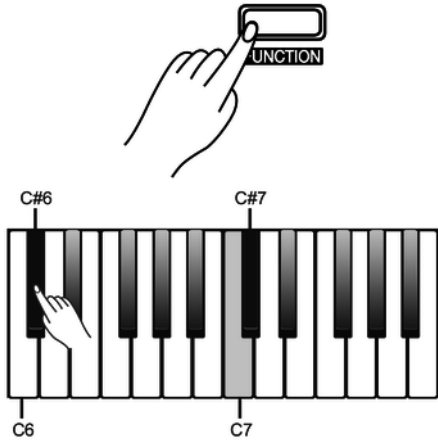

With this function you can adjust the pitch of the keyboard in 12 semitone steps up or down.

1. ➤ Hold down the [FUNCTION] button and press piano key [C#6].
2. ➤ Hold down the [FUNCTION] button and press piano key [C7] or [C#7] to transpose the keyboard pitch in 12 semitone steps up or down.



- Hold down the [FUNCTION] button and press piano key [C7] and [C#7] simultaneously to restore the preset value '00'.
- For example, if you set the transpose value to '-05' or '+07', you will hear the pitch [G] while playing the [C] keys.

7.6 Fine tuning

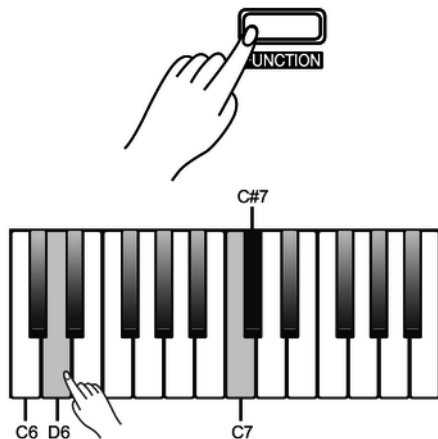

With this function you can fine tune the entire keyboard in 2-cent steps.

1. ➤ Hold down the [FUNCTION] button and press piano key [D6].
2. ➤ Hold down the [FUNCTION] button and press piano key [C7] or [C#7] to fine tune the keyboard. The value changes by 2 Cents per keystroke in a range from -50 bis +50 Cents.



- Hold down the [FUNCTION] button and press piano key [C7] and [C#7] simultaneously to restore the preset value '0 Cent'.

7.7 Metronome

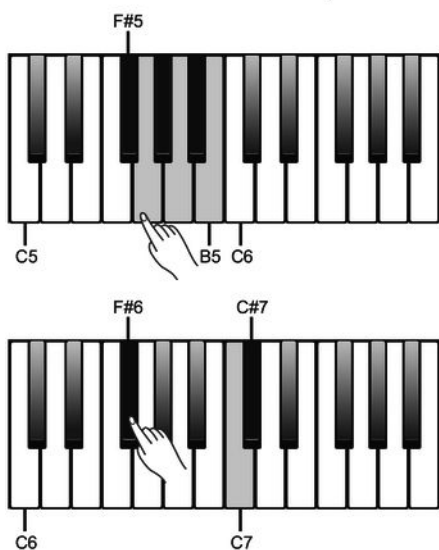
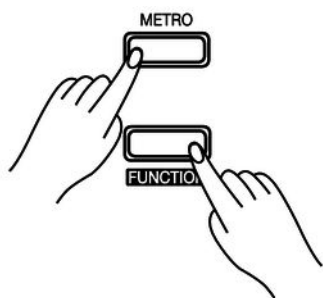

The digital piano metronome has six preset time signatures.

1. ▶ Turning the metronome on / off

Press the [METRO] button to turn the Metronome on or off.

2. ▶ Setting the time signature

Press the buttons </> to set one of the preset time signatures '0', '2', '3', '4', '5' or '6'.

Hold down the [FUNCTION] button and press one of the piano keys [F#5] ... [B5] to set the time signature directly.

3. ▶ Setting the Click volume

Hold down the [FUNCTION] button and press piano key [F#6].

Hold down the [FUNCTION] button and press piano key [C7] or [C#7] to adjust the Click volume between '0' ... '15'.



Hold down the [FUNCTION] button and press piano keys [C7] and [C#7] simultaneously to restore the default value.

– The metronome is not available while playing practice pieces.

7.8 Tempo

All preprogrammed pieces and voices as well as the metronome function are stored with certain tempo information. These presets can be adjusted at any time in various ways.

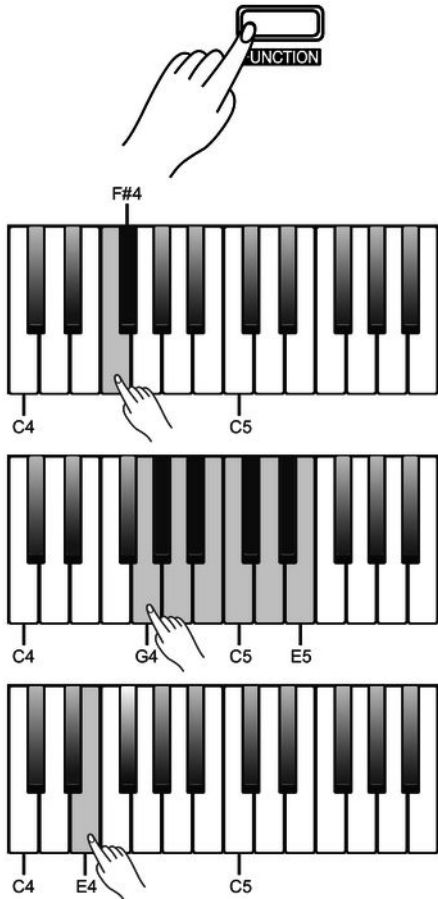

1. ➤ Hold down the [FUNCTION] button and press piano key [F4] or [F#4] to adjust the tempo in steps of 1.
2. ➤ Hold down the [FUNCTION] button and press the </> buttons to adjust the tempo in steps of 10.
3. ➤ Hold down the [FUNCTION] button and press one of the piano keys [G4] ... [E5] to adjust the tempo directly.
4. ➤ Hold down the [FUNCTION] button and press piano key [E4] repeatedly in the desired tempo to set the tempo.



- Hold down the [FUNCTION] button and press piano keys [F4] and [F#4] simultaneously, the tempo will be reset to the default standard value (120 beats per minute).
- The tempo can be adjusted in a range from 30 to 280 bpm.
- If you want to change the tempo using one of the piano keys [G4] to [E5], you always have to enter it in three-digit format. For example, to set tempo 214, hold down the [FUNCTION] button and press the piano keys [A4,] [G#4] and [B4] one after the other.

7.9 Button sound

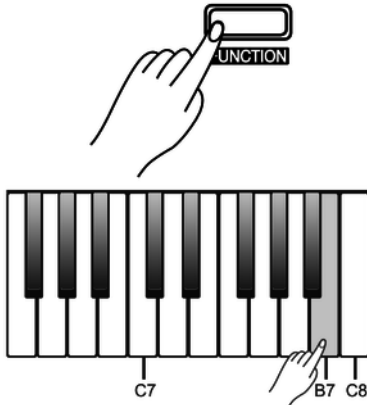

With this function, you can turn the Key Tone on or off. By default, the Key Tone is turned on.

- Hold down the [FUNCTION] button and press the piano key [B7] to turn the button sound on or off.



- When you turn on the button sound, you will hear a sound each time you press a function button.

7.10 Pedal resonance

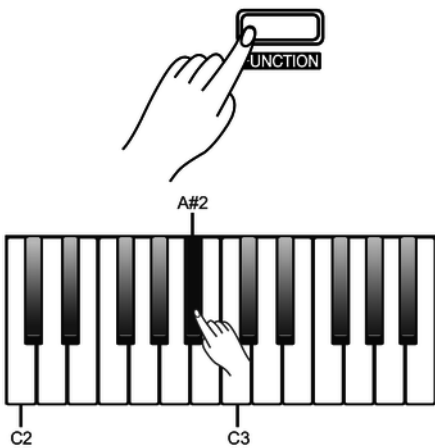

This function mimics the sustain effect of a piano.

- Press and hold the [FUNCTION] button. Press the piano key [A#2] to turn the effect on or off.



- The resonance effect is activated as soon as the digital piano is switched on.
- While the resonance effect is activated, the chorus effect of the digital piano is suppressed.
- There may be a brief pause if you turn the Resonance effect on or off during playing.

8 Operating

8.1 Demo song

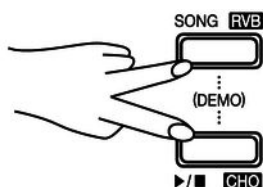

The built-in demo song shows the sound and the pitch range of the instrument.

1. ▶ Simultaneously press the buttons [SONG/RVB] and ▶/■/[CHO] to start the playback of the demo song. The demo song is playing in an endless loop.
2. ▶ Press the ▶/■/[CHO] button again to stop the playback.



During playback, the piano keys are muted.

8.2 Practising songs

8.2.1 Selecting practise songs



The digital piano offers 60 practise songs in total (see [Chapter 9 'Practise and demo songs'](#) on page 36).

1. ▶ Press the [SONG/RVB] button to enter the playback mode for practise songs. The [SONG/RVB] button LED lights up. All practise songs are played in an endless loop.
2. ▶ Press the </> buttons during playback to select a desired practice song. Press the ▶/■/[CHO] button to play the selected practice song in an infinite loop.
3. ▶ Press the ▶/■/[CHO] button to stop playback and exit the current mode.

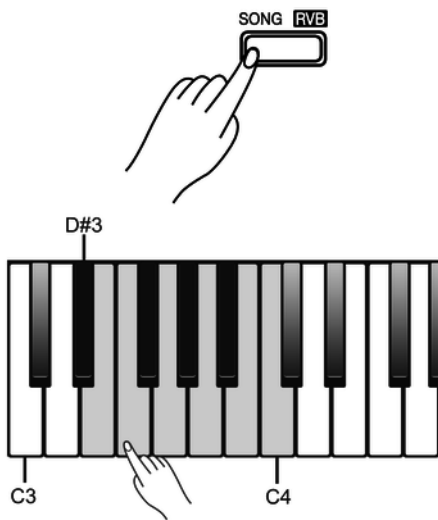

4. ▶ Selecting a practise song directly

Hold down the [FUNCTION] button and press one of the piano keys [D#3] ... [C4] during playback to select the desired practise song.



To select the practise song with the piano keys [D#3] ... [C4], always enter the number in two-digit format. If you want to select the eighth practise song, for example, press the piano keys [D#3] and [B3] one after the other.

8.2.2 Practising left and / or right hand

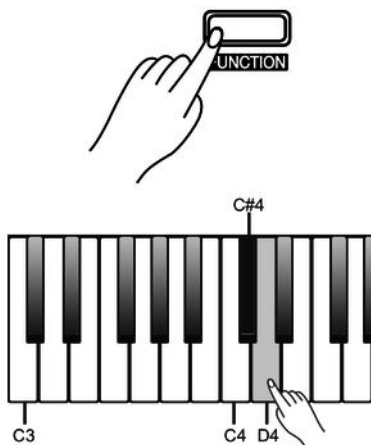

In [SONG] mode, you can set whether to play both tracks of the practise song or only the left or right track so that hands can practice individually or together.

1. ▶ To mute the left track of the practice song, hold down the [FUNCTION] button and press piano key [C#4].
To deactivate the setting, hold down the [FUNCTION] button and press piano key [C#4] again.
2. ▶ To mute the right track of the practice song, hold down the [FUNCTION] button and press piano key [D4].
To deactivate the setting, hold down the [FUNCTION] button and press piano key [D4] again.

8.3 Voices

8.3.1 Selecting voices

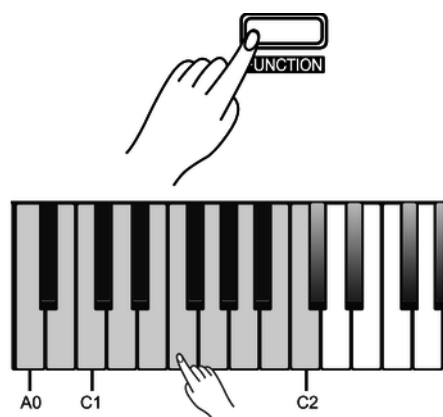

Overall, the digital piano has 16 voices, which can be accessed via piano keys [A0] ... [C2] (see [Chapter 10 'Voice list' on page 38](#)). A preset voice is assigned to each piano key.

1. ➤ Hold down the [FUNCTION] button and press one of the piano keys [A0] ... [C2] to select the desired voice.
2. ➤ To select another voice, hold down the [FUNCTION] button again and press one of the piano keys [A0] ... [C2].
3. ➤ Press the </> buttons to select a desired voice.

Alternatively, you can call up the 16 voices of the digital piano via the </> buttons (see [Chapter 10 'Voice list' on page 38](#)).

8.3.2 Split mode

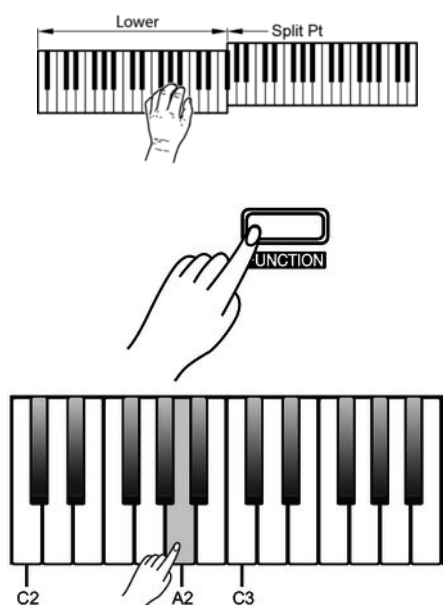

This feature allows you to select a point that splits the entire keyboard into two sections and to assign different voices to those sections. The preset split point is on piano key [F#3].

1. ➤ Hold down the [FUNCTION] button and press piano key [A2]. Select the desired piano key that you want to be the split point. Usually, the split point lies within the piano keys [C3] ... [C6].
2. ➤ Release the [FUNCTION] button to apply the setting.
3. ➤ To assign voices to the two sections, first select the first voice as described in chapter [Chapter 8.3.1 'Selecting voices' on page 27](#).

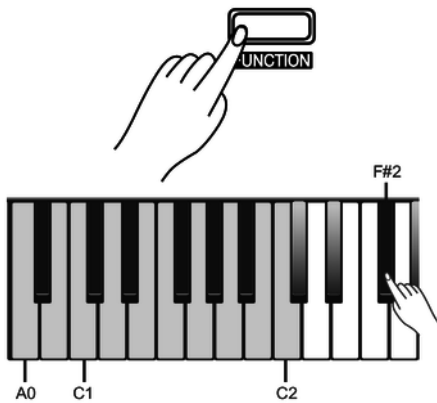

4. ➤ To assign the second voice, hold down the [FUNCTION] button and press piano key [F#2] to start the split mode. The preset second voice is 'String Ensembles'.
5. ➤ Hold down the [FUNCTION] button and press piano key [F#2] again. Use one of the piano keys [A0] ... [C2] to select the second voice.
6. ➤ Hold down the [FUNCTION] button and press piano key [F#2] again to exit the split mode.

8.3.3 Dual mode

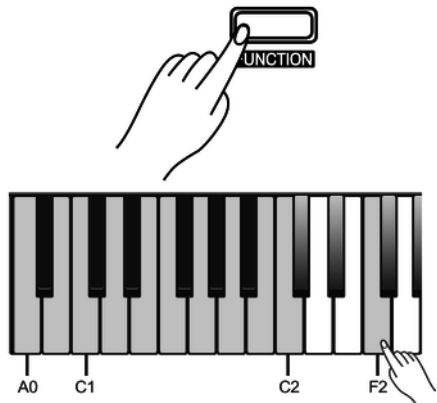

In Dual mode, you can play two voices simultaneously.

1. ➤ First, select the first voice as described in section [Chapter 8.3.1 'Selecting voices'](#) on page 27.
2. ➤ Hold down the [FUNCTION] button and press piano key [F2] to start the dual mode. The preset second voice is 'String Ensembles'.
3. ➤ Hold down the [FUNCTION] button and press piano key [F2] again. Use one of the piano keys [A0] ... [C2] to select the second voice.
4. ➤ Hold down the [FUNCTION] button and press piano key [F2] again to exit the dual mode.



When split mode and dual mode are selected, only the right track can play the second voice.

8.3.4 Demo mode

The digital piano offers 16 demos for the individual voices.

1. ➤ First, select the first voice as described in section [Chapter 8.3.1 'Selecting voices'](#) on page 27.
2. ➤ Hold down the [FUNCTION] button and press piano key [G2] to start the demo for the selected voice.
3. ➤ Press piano key [G2] again or press the ▶/■/[CHO] button to exit the demo mode.

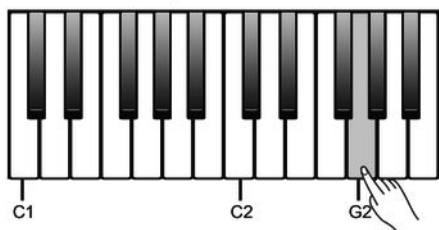
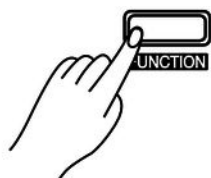

During playback, the piano keys are muted.

8.3.5 Duet mode

8.3.5.1 Turning the duet mode on and off

With this feature on, the digital piano automatically creates a matching accompanying voice when chords are played in the chord section of the keyboard. The digital piano offers 32 duet patterns.

1. ➤ Hold down the [FUNCTION] button and press piano key [B2] to start the duet mode.
2. ➤ Hold down the [FUNCTION] button and select the desired duet pattern with the piano keys [C3] or [C#3].
3. ➤ Press [B2] again to deactivate the function again.

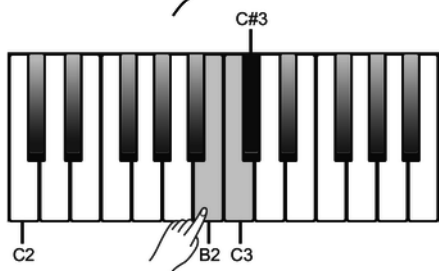
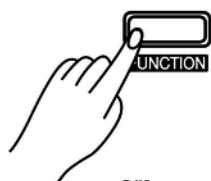

A preset duet pattern is assigned to each voice.

8.3.5.2 Setting duet split point

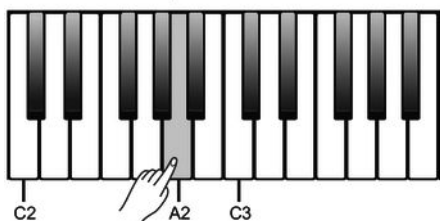
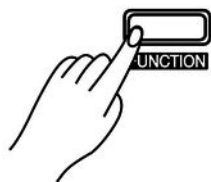

In duet mode, to play the chords in the chord section with your left hand and the melody with your right hand, you can select a point that splits the entire keyboard into two sections.

1. ➤ Hold down the [FUNCTION] button and press piano key [A2]. Select the desired piano key that you want to be the split point.
2. ➤ Release the [FUNCTION] button to apply the setting.

8.3.6 TWINOVA

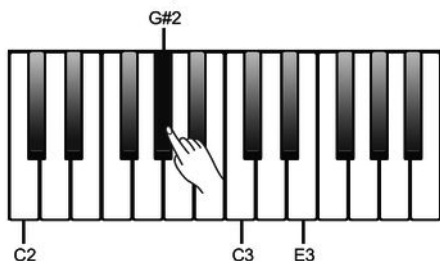
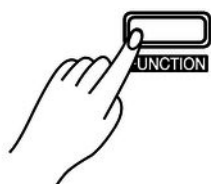

In TWINOVA mode, the keyboard is divided into two areas with the same voice and the same pitch.

1. ➤ Hold down the [FUNCTION] button and press piano key [G#2] to start the TWINOVA mode.
2. ➤ Select the desired voice, see [Chapter 8.3.1 'Selecting voices' on page 27](#).
3. ➤ If necessary, specify a split point, see [Chapter 8.3.2 'Split mode' on page 27](#). The preset split point is on piano key [E3].
4. ➤ If necessary, adapt the Octave area, see [Chapter 7.5 'Transposing' on page 21](#).
5. ➤ Hold down the [FUNCTION] button and press piano key [G#2] again to deactivate the TWINOVA mode.

8.4 Digital effects

8.4.1 Chorus effect

The Chorus function lets you simulate the acoustic effects under different environmental conditions.

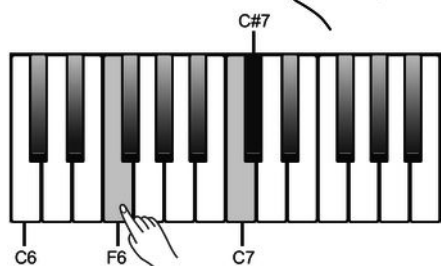
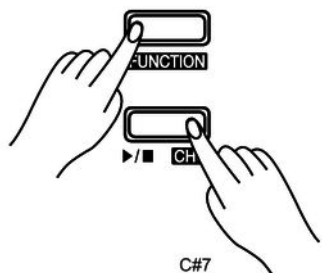

1. ➤ Hold down the [FUNCTION] button and press the ►/■/[CHO] button to turn the Chorus effect on or off.
2. ➤ Hold down the [FUNCTION] button and press piano key [F6] to call up the configuration mode of the Chorus effect.
3. ➤ Hold down the [FUNCTION] button and press piano key [C7] or [C#7] to set the desired effect between '1' ... '5'.
4. ➤ To restore the default settings, hold down the [FUNCTION] button in configuration mode and simultaneously press [C7] and [C#7].

Parameter	Effect	Meaning
[1]	Chorus 1	Slight Chorus effect
[2]	Chorus 2	Medium Chorus effect
[3]	Chorus 3	Strong Chorus effect
[4]	Flanger	Flanger effect
[5]	Rotary	Rotary effect



- By default, the Chorus effect is deactivated when the digital piano is switched on.
- While the Chorus effect is activated, the Resonance effect of the digital piano is suppressed.

8.4.2 Reverb effect

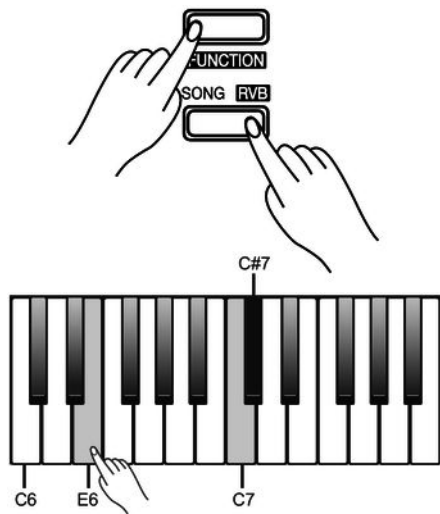

With this function you can turn on the Reverb effect and select the effect type.

1. ➔ Hold down the [FUNCTION] button and press the [SONG/RVB] button to turn the Reverb effect on or off.
2. ➔ Hold down the [FUNCTION] button and press piano key [E6].
3. ➔ Hold down the [FUNCTION] button and press piano key [C7] or [C#7] to set the desired effect between '1' ... '5'.

Parameter	Effect	Meaning
[1]	Room	Room
[2]	Reverb	Reverb
[3]	Church	Church
[4]	Delay	Delay
[5]	Pan Delay	Pan Delay



Hold down the [FUNCTION] button and press piano keys [C7] and [C#7] simultaneously to restore the preset value '3'.

8.4.3 Dynamic Acoustic System (DAS)

With this function you can adjust the tone at low volumes to the characteristic of human hearing. The level of extremely high and low frequencies is dynamically increased when reducing the volume.

The Dynamic Acoustic System (DAS) is activated automatically when powering up the digital piano.

- ➔ Hold down the [FUNCTION] button and press the piano key [A7] to activate or deactivate the DAS function.

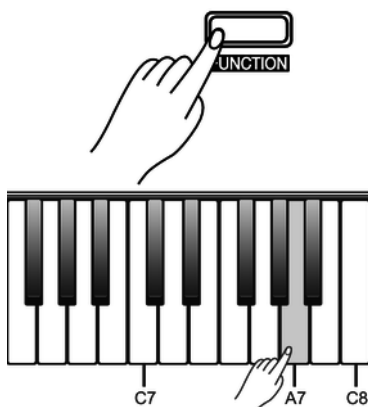

8.5 Recording function

You can record your own songs with the digital piano and save up to five recordings as user songs in the internal memory. Unsaved recordings are lost after switching the digital piano off.

8.5.1 Preparing and starting recording

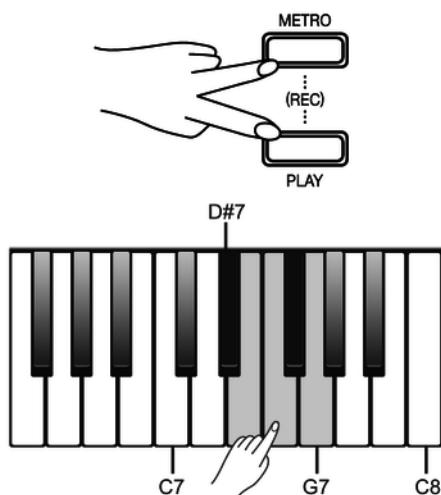

1. ➤ Press the *[METRO]* and *[PLAY]* buttons simultaneously to enable the recording mode.
2. ➤ Press one of the piano keys *[D#7]* ... *[G7]* to select a memory location for recording.
 - ⇒ The digital piano is now record enabled. The ▶/■/*[CHO]* button LED flashes.
3. ➤ Set the recording tempo.
4. ➤ Recording starts as soon as you press the ▶/■/*[CHO]* button or play the first note or chord.
 - ⇒ The *[METRO]* and *[PLAY]* button LEDs light up.

8.5.2 Stopping recording

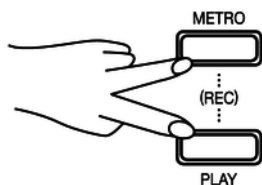

You can cancel or stop recording at any time.

- During recording, press the *[METRO]* and *[PLAY]* buttons simultaneously to stop recording.
 - ⇒ The recording is stopped and saved to the selected memory location. The *[METRO]* and *[PLAY]* button LEDs turn off.



- The recording previously saved in the selected memory location is overwritten.
- When the full memory capacity has been reached, the recording is terminated automatically and the recorded data is saved.

8.5.3 Playing a recording

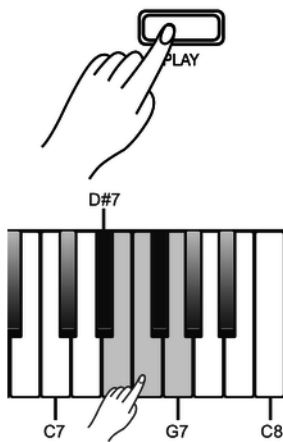

1. ➤ Hold down the [PLAY] button and press one of the piano keys [D#7] ... [G7] to select the desired recording.
2. ➤ Press the [PLAY] button to play back the recording.
⇒ The [PLAY] button LED lights.
3. ➤ Press the [PLAY] button again to stop the playback.
⇒ The [PLAY] button LED goes out.

8.5.4 Deleting recordings

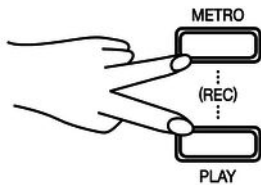

Deleting single recordings

1. ➤ Switch to playback mode and select the desired recording as described in [Chapter 8.5.3 'Playing a recording' on page 34](#).
2. ➤ Hold down the [METRO] and [PLAY] buttons simultaneously.
⇒ The selected recording is deleted.

Deleting all recordings

1. ➤ Turn off the digital piano.
2. ➤ Simultaneously press the [METRO] and [PLAY] buttons and turn the digital piano back on.
⇒ All user recordings are deleted.

8.6 MIDI functions

8.6.1 USB connection to a computer

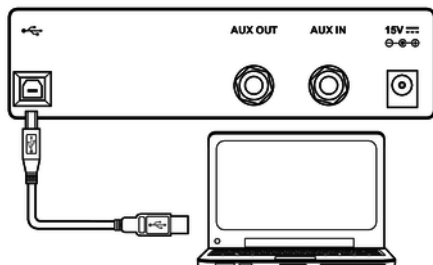

1. ➤ Turn on the computer.
2. ➤ Connect the USB port on the rear panel of the digital piano using a standard USB cable (not included) to the USB port on your computer.
3. ➤ Then turn the digital piano on.

Please heed the following instructions when connecting USB instruments to computers. Otherwise, the instrument or the computer may 'crash', which can result in data loss. If a 'crash' should occur, turn off computer and instrument and restart both after a few seconds.



- If the computer is in standby or hibernation, wake the computer before connecting the USB cable.
- Establish the USB connection between computer and instrument before turning on the instrument.
- For additional applications you may need a suitable software for recording and editing music (not included).

8.6.2 Setting the MIDI channel

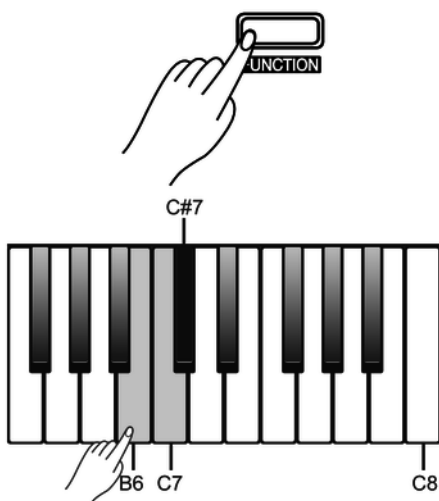

1. ➤ Hold down the [FUNCTION] button and press piano key [B6].
2. ➤ Hold down the [FUNCTION] button and press piano key [C7] or [C#7] to set the desired MIDI OUT channel between '1' ... '16'.



Hold down the [FUNCTION] button and press piano keys [C7] and [C#7] simultaneously to restore the preset value '1'.

9 Practise and demo songs

Practising songs

No.	Name	No.	Name
1	The Entertainer	31	Robot Doll
2	Rialto Ripples (Rag)	32	Consolation
3	Neapolitan Song	33	2-Part Invention #13 In A Minor.B.W. III
4	Waltzes	34	Minuet In G Major (BWV Anh. 114)
5	Turkish March	35	Barcarolle
6	Schos Doll's Dance No. 2	36	Norwegian Dance No.2
7	Minuet In D Major	37	Moseta Dance
8	Inquietude	38	The Small Gathering
9	Italian Polka	39	The Return
10	Moment Musical	40	The Wagtail
11	Prelude In C-Sharp Major	41	Bulie Dance
12	The Happy Farmer	42	Tender Blossom
13	The Rag-Time Dance	43	Grace
14	Piano Sonata In C Major, K.330. III	44	Cherish The Memories
15	Mazurka	45	Chopsticks
16	Prelude In E Major	46	Four Little Swans
17	Piano Sonata In A Major, K.331. I	47	Progress
18	Waltz For Piano In G-Sharp Minor	48	Eclogue
19	Gavotte	49	The Limpid Stream
20	L'Arabesque	50	Brave Cavalier
21	Austria Variation	51	The Chatterbox
22	Schos Doll's Dance No. 7	52	Tarantella
23	To A Wild Rose	53	Frankness
24	Gavotte I	54	Tender Grieving
25	Waltz	55	The Farewell
26	Minuet In G Major (BWV Anh. 116)	56	The Chase
27	Innocence	57	Habanera
28	Tchaikovsky Waltz	58	Prelude In C Major
29	Salut d' Amour	59	Fountain
30	Barcarolle	60	Für Elise

Demo song

No.	Name
1	Fantasia

10 Voice list

No.	Name	No.	Name
1	Grand Piano	9	Drawbar Organ
2	Grand Piano 2	10	Jazz Organ
3	Chorus Piano	11	Rock Organ
4	E.Piano 1	12	Pipe Organ
5	E.Piano 2	13	Accordion
6	Harpichord	14	Harmonica
7	Clavi	15	String Ensembles
8	Vibraphone	16	Soprano Sax

11 MIDI implementation chart

Function		Sent	Received	Notes
Basic Channel	Default	1	ALL	
	Changed	1-16	1-16	
Mode	Default	No	Mode 3	
	Messages	No	Mode 3	
	Altered	*****	No	
Note Number		0 – 127	0 – 127	
	True voice	*****	0 – 127	
Velocity Note	Note ON	Yes, 9nH, v = 1 – 127	Yes, 9nH, v = 1 – 127	
	Note OFF	No, 9nH, v = 0	Yes, 9nH, v = 0 or 8nH, v = 0 – 127	
After Touch	Keys	No	No	
	Channels	No	No	
Pitch Bend		No	Yes	
Control Change	0	Yes	Yes	Bank Select
	1	No	Yes	Modulation
	5	No	Yes	Portamento Time
	6	Yes	Yes	Data Entry
	7	Yes	Yes	Volume
	10	No	Yes	Pan
	11	No	Yes	Expression
	64	Yes	Yes	Sustain Pedal
	65	No	Yes	Portamento ON/OFF
	66	Yes	Yes	Sostenuto Pedal
	67	Yes	Yes	Soft Pedal
	80	Yes	Yes	Reverb Program
	81	Yes	Yes	Chorus Program
	91	Yes	Yes	Reverb Level
	93	Yes	Yes	Chorus Level
	120	Yes	Yes	All Sound Off
121	No	Yes	Reset All Controllers	
123	Yes	Yes	All Notes Off	

MIDI implementation chart

Function		Sent	Received	Notes
Program Change	True #	Yes *****	Yes 0 – 127	
System Exclusive		No	Yes	
System Common	Song Position Pointer	No	No	
	Song Select	No	No	
	Tune Request	No	No	
System Real Time	Clock	Yes	No	
	Commands	No *1	No *1	
Aux Messages	Local ON/OFF	No	No	
	Active Sensing	No	Yes	
	System Reset	No	Yes	
Notes:	*1 When the accompaniment starts, an FAH message is transmitted. When the accompaniment stops, an FCH message is transmitted.			

MIDI channel modes

	POLY	MONO
OMNI ON	Mode 1	Mode 2
OMNI OFF	Mode 3	Mode 4

12 Troubleshooting

Problem	Possible causes and solutions
You hear a 'pop' sound from the speakers when switching the digital piano on and off.	This is normal. No need to worry.
No sound can be heard when playing the piano.	<p>Make sure that the volume control is set appropriately.</p> <p>Check if headphones are plugged into the headphone output 2. Connecting headphones will mute the speakers of the digital piano.</p>
Malfunction occurs when using a mobile phone.	Using a mobile phone near the digital piano can cause interference. To prevent this, turn off the mobile phone or use it only at a safe distance.
A connected computer does not detect the digital piano.	<p>Check if the USB cable is connected properly.</p> <p>Connect the USB cable to another USB port on the computer.</p>

13 Technical specifications

Input connections	Power supply	DC connection for power adapter
	USB port	USB-to-Host
	AUX in	1 × 1/4" jack socket
Output connections	Headphones	2 × 1/4" jack socket
	AUX out	1 × 1/4" jack socket
Keyboard	88 weighted keys with hammer action	
	Touch sensitivity adjustable	
Polyphony	128-voice polyphony	
Sounds	16	
Effects	Hall, Chorus, Reverb, DAS	
Pedals	Soft, Sostenuto, Sustain	
Pitch adjustment	Transposing	-12 ... +12
	Voices	-50 ... 50
Functions	Metronome	0, 2, 3, 4, 5 or 6
	Tempo	30 ... 280
Demo and practice songs	61	
Memory	5 × memory locations for user recordings	
Speaker	2 × 10 W	
Amp	2 × 20 W	
Power supply	Power adapter (15 V ^{DC} / 2500 mA, centre positive)	
Operating system	Windows 7, Windows 8, Windows 10, Mac OSX and higher	
Dimensions (W × H × D)	1320 mm × 815 mm × 440 mm	
Weight	38.5 kg	
Colour	Matt black	Item number 448686
	Matt white	Item number 448687
Ambient conditions	Temperature range	0 °C...40 °C
	Relative humidity	50 %, non-condensing

Further information

Surface	Satined
Wooden keyboard	No
Ivory-feel keyboard	No
Auto Accompaniment	No
Number of rhythms	0

14 Plug and connection assignment

Introduction

This chapter will help you select the right cables and plugs to connect your valuable equipment in such a way that a perfect sound experience is ensured.

Please note these advices, because especially in 'Sound & Light' caution is indicated: Even if a plug fits into the socket, an incorrect connection may result in a destroyed power amp, a short circuit or 'just' in poor transmission quality!

Balanced and unbalanced transmission

Unbalanced transmission is mainly used in semi-professional environment and in hifi use. Instrument cables with two conductors (one core plus shielding) are typical representatives of the unbalanced transmission. One conductor is ground and shielding while the signal is transmitted through the core.

Unbalanced transmission is susceptible to electromagnetic interference, especially at low levels, such as microphone signals and when using long cables.

In a professional environment, therefore, the balanced transmission is preferred, because this enables an undisturbed transmission of signals over long distances. In addition to the conductors 'Ground' and 'Signal', in a balanced transmission a second core is added. This also transfers the signal, but phase-shifted by 180°.

Since the interference affects both cores equally, by subtracting the phase-shifted signals, the interfering signal is completely neutralized. The result is a pure signal without any noise interference.

1/4" TRS phone plug (stereo, unbalanced)



1	Signal (left)
2	Signal (right)
3	Ground

15 Protecting the environment

Disposal of the packaging material



For the transport and protective packaging, environmentally friendly materials have been chosen that can be supplied to normal recycling.

Ensure that plastic bags, packaging, etc. are properly disposed of.

Do not just dispose of these materials with your normal household waste, but make sure that they are collected for recycling. Please follow the notes and markings on the packaging.

Disposal of your old device



This product is subject to the European Waste Electrical and Electronic Equipment Directive (WEEE) in its currently valid version. Do not dispose with your normal household waste.

Dispose of this device through an approved waste disposal firm or through your local waste facility. When discarding the device, comply with the rules and regulations that apply in your country. If in doubt, consult your local waste disposal facility.

