

# DRAWMER



## MC3.1 MONITOR CONTROLLER



## CONTENTS

Warranty .....	3
Safety Consideration .....	3
Radio Frequencies Statement .....	3
 <i>Chapter 1 - Introduction</i>	
Introduction .....	4
Installation .....	6
Power Connection .....	7
Security .....	7
Portable Appliance Testing .....	7
Audio Connection .....	8
Typical Connection Guide .....	9
 <i>Chapter 2 - Control Description</i>	
Control Description Intro .....	10
Monitor Calibration .....	18
Mix Checking Tips .....	22
 <i>Chapter 3 - General Information</i>	
If a fault develops .....	26
Contacting Drawmer .....	26
Specification .....	26
Block Diagram .....	27

# **DRAWMER**

---

## **COPYRIGHT**

This manual is copyrighted © 2016 by Drawmer Electronics Ltd. With all rights reserved. Under copyright laws, no part of this publication may be reproduced, transmitted, stored in a retrieval system or translated into any language in any form by any means, mechanical, optical, electronic, recording, or otherwise, without the written permission of Drawmer Electronics Ltd.

## **ONE YEAR LIMITED WARRANTY**

Drawmer Electronics Ltd., warrants the Drawmer **MC3.1 Monitor Controller** to conform substantially to the specifications of this manual for a period of one year from the original date of purchase when used in accordance with the specifications detailed in this manual. In the case of a valid warranty claim, your sole and exclusive remedy and Drawmer's entire liability under any theory of liability will be to, at Drawmer's discretion, repair or replace the product without charge, or, if not possible, to refund the purchase price to you. This warranty is not transferable. It applies only to the original purchaser of the product.

For warranty service please call your local Drawmer dealer. Alternatively call Drawmer Electronics Ltd. at +44 (0)1709 527574. Then ship the defective product, with transportation and insurance charges pre-paid, to Drawmer Electronics Ltd., Coleman Street, Parkgate, Rotherham, S62 6EL UK. Write the RA number in large letters in a prominent position on the shipping box. Enclose your name, address, telephone number, copy of the original sales invoice and a detailed description of the problem. Drawmer will not accept responsibility for loss or damage during transit.

This warranty is void if the product has been damaged by misuse, modification, unauthorised repair or installed with other equipment that proved to be faulty.

THIS WARRANTY IS IN LIEU OF ALL WARRANTIES, WHETHER ORAL OR WRITTEN, EXPRESSED, IMPLIED OR STATUTORY. DRAWMER MAKES NO OTHER WARRANTY EITHER EXPRESS OR IMPLIED, INCLUDING, WITHOUT LIMITATION, ANY IMPLIED WARRANTIES OF MERCHANTABILITY, FITNESS FOR A PARTICULAR PURPOSE, OR NON-INFRINGEMENT. PURCHASER'S SOLE AND EXCLUSIVE REMEDY UNDER THIS WARRANTY SHALL BE REPAIR OR REPLACEMENT AS SPECIFIED HEREIN.

IN NO EVENT WILL DRAWMER ELECTRONICS LTD. BE LIABLE FOR ANY DIRECT, INDIRECT, SPECIAL, INCIDENTAL OR CONSEQUENTIAL DAMAGES RESULTING FROM ANY DEFECT IN THE PRODUCT, INCLUDING LOST PROFITS, DAMAGE TO PROPERTY, AND, TO THE EXTENT PERMITTED BY LAW, DAMAGE FOR PERSONAL INJURY, EVEN IF DRAWMER HAS BEEN ADVISED OF THE POSSIBILITY OF SUCH DAMAGES.

Some states and specific countries do not allow the exclusion of implied warranties or limitations on how long an implied warranty may last, so the above limitations may not apply to you. This warranty gives you specific legal rights. You may have additional rights that vary from state to state, and country to country.

### **For the USA**

#### **FEDERAL COMMUNICATIONS COMMISSION RADIO FREQUENCY INTERFERENCE STATEMENT**

This equipment has been tested and found to comply with the limits for a Class B digital device, pursuant to Part 15 of the FCC Rules. These limits are designed to provide reasonable protection against harmful interference in a residential installation. This equipment generates, uses and can radiate radio frequency energy and, if not installed and used in accordance with the instructions, may cause harmful interference to radio communications. However, there is no guarantee that interference will not occur in a particular installation. If this equipment does cause interference to radio or television reception, which can be determined by turning the equipment off an on, then the user is encouraged to try to correct the interference by one or more of the following measures:

- Re-orient or relocate the receiving antenna.
- Increase the separation between the equipment and the receiver.
- Connect the equipment into an outlet on a circuit different from that to which the receiver is connected.
- Consult the dealer or an experienced radio/TV technician for help.

Unauthorised changes or modification to this system can void the users' authority to operate this equipment.

This equipment requires shielded interface cables in order to meet FCC class B limit.

### **For Canada**

#### **CLASS B NOTICE**

This digital apparatus does not exceed the Class B limits for radio noise emissions set out in the Radio Interference Regulations of the Canadian Department of Communications.

#### **CLASSE B AVIS**

Cet appareil numérique ne dépasse pas les limites de la classe B au niveau des émissions de bruits radioélectriques fixés dans le Règlement des signaux parasites par le ministère Canadien des Communications.

## **SAFETY CONSIDERATIONS**

### **CAUTION - SERVICING**

DO NOT OPEN. REFER ALL SERVICING TO QUALIFIED SERVICE PERSONNEL.

### **WARNING**

TO REDUCE RISK OF FIRE/ELECTRIC SHOCK DO NOT EXPOSE THIS EQUIPMENT TO MOISTURE.

### **WARNING**

DO NOT ATTEMPT TO CHANGE OR TAMPER WITH THE SUPPLIED POWER SUPPLY OR CABLES.

### **WARNING**

THERE ARE NO REPLACEABLE FUSES WITHIN EITHER THE MC3.1 OR IT'S SUPPLIED POWER SUPPLY. IF FOR ANY REASON THE MC3.1 CEASES TO WORK DO NOT ATTEMPT TO MEND IT - CONTACT DRAWMER TO ARRANGE FOR A REPAIR/REPLACEMENT.

**In the interests of product development, Drawmer reserve the right to modify or improve specifications of this product at any time, without prior notice.**

# MC3.1 Monitor Controller

Building on the success of the MC2.1, the MC3.1 Monitor Controller is just as accurate and transparent and of the same build quality. It can still faithfully reproduce what has been recorded without colouring the sound, but comes with a much expanded feature set, including more inputs, better control, extended channel routing and a desk top 'wedge' form factor.



Additions include a combined digital AES/SPDIF (24 bit/192kHz) input, giving a total of 5 individually switchable sources, including a front panel auxiliary input with level control for the easy connection of your mp3 player, smartphone or tablet. Full cue mix facilities, with level control, provide separate source selection for main or cue outputs and the two headphone amplifiers, so the artist can listen to a completely different mix to the engineer, for example. A dedicated cue mix output is also available.

A secondary preset volume control on the front provides repeatable calibrated output level for the monitors, so that at the flick of a switch the engineer can hear the mix at the same predetermined volume, time after time, without having to meticulously adjust controls.

The MC3.1 incorporates three stereo balanced speaker outputs, plus a dedicated mono speaker/sub-woofer output each with individual left/right trims under the unit to provide complete control over level matching. Furthermore each can be switched individually and simultaneously and in any order. You can listen to multiple speakers with the same sub-woofer, or turn the sub-woofer off altogether.

Other improvements include additional mix checking capabilities, which now incorporate low, mid, high solo switches to hear how the lows bleed into the mid, or the stereo width of each, for example, and also the ability to swap the left and right channels. The talkback has been expanded to include footswitch operation and an external mic in addition to the internal.

---

Can you trust the audio that your current monitor controller is providing? Is it colouring the sound? For all Drawmer monitor controllers it is imperative that what you record is exactly what you hear. The active circuit has been designed to faithfully produce the audio signal whilst removing many of the problems that a passive circuit will bring.

There is one thing that should always be absolutely guaranteed - that you can rely on the accuracy of your monitor controller.



- Ultra low noise and transparent circuit design.
- Source switches for both Main & Cue can be active in any combination. 5 Inputs in Total - 1x Digital AES/SPDIF Neutrik XLR/JACK COMBI & 2 balanced analogue Neutrik XLR/JACK COMBI and 1 stereo RCA Analogue on the Rear Panel & 1 3.5mm Front Panel Aux.
- 3x Speakers Plus a Mono Sub can be switched individually & simultaneously or give A/B comparisons. Each has level trims to provide precise channel matching.
- Timed relay protection on all speaker outputs to prevent power up/down bangs.
- Volume can be set via the Variable Front Panel Knob or a Preset Control. Each has paralleled custom quad pots for excellent channel matching and smooth feel.
- 2x Headphone Amplifiers with Individual Level Controls & Switching between Main & Cue Inputs so the Artist can listen to a Different Mix to the Engineer.
- Front Panel 3.5mm AUX Input & Level Control for connecting MP3 player, smartphone or tablet etc.
- Cue Level Control adjusts the volume for the Artist's Monitors.
- Built In Talkback with Level Control, Internal or External Microphone, Switching via Desktop or Footswitch, a Mono Output Jack & Internal Routing to Headphone and Cue Outputs.
- Comprehensive Mix Checking facilities Including Low, Mid, High Solo; Dim; L/R Mute; Phase Reverse and more, help check every aspect of your Mix & Provide Ultimate Control.
- Desktop 'wedge' form factor.
- Kensington security slot.
- Rugged steel chassis and stylish brushed aluminium cover

# DRAWMER

## Compare the MC2.1 and MC3.1 Features

	MC2.1	MC3.1		MC2.1	MC3.1
Ultra low noise and transparent circuit design.	●	●	<b>Outputs:</b> Left/Right Bal. XLR O/P Mono/Sub Bal. XLR O/P Individual Mono/Sub Select Individual Speaker O/P Trims Timed Relay Protection Cue O/P with Level Control	3	3
Paralleled Quad Pots on Main & Headphone Level Controls	●	●		1	1
Accurate & Smooth Volume Knob	●	●		●	●
Adjustable Preset Volume	●	●		●	●
<b>Inputs:</b>	(4)	(5)	<b>TalkBack:</b> Built In (Internal) Individual Level Control Dedicated TalkBack O/P Jack Internal Headphone Routing. External Mic Input Footswitch Routing to Cue O/P		
Bal. Neutrik XLR/Jack Combi	1	2		●	●
Bal. Neutrik XLR	1	0		●	●
AUX Left/Right Phono	1*	1		●	●
AUX 3.5mm jack for MP3 etc.	1*	1		●	●
Digital AES / SPDIF Combi	0	1*		●	●
*shared inputs					
Individual Main Source Selects	3	5	<b>Headphones:</b>	2	2
Individual Cue Source Selects.	0	5		●	●
<b>Comprehensive Mix Checking:</b>			●	●	
Left & Right Cut	●	●	●	●	
Phase Reverse	●	●	●	●	
Mono	●	●	●	●	
Dim	●	●	●	●	
Mute	●	●	●	●	
Low, Mid, High Band Solo	●	●	●	●	
Left - Right Swap	●	●	●	●	
			<b>Chassis:</b>		
			Rugged Steel & Aluminium	●	●
			Stackable & Rack Mountable	●	●
			Desktop Wedge Shaped	●	●

## INSTALLATION

The MC3.1 is a free standing, desktop unit, with controls and headphone jacks on the front panel and all other inputs and outputs on the rear.

### Screwing the MC3.1 to a desk.

Rather than having the MC3.1 free standing it can be fastened down to a desk by utilising the holes that hold the rubber feet to the underside. Note that when fixing to a desk the speaker trims on the base of the unit will not be accessible and so the calibration procedure should be carried out before fastening the MC3.1 in place (see 'Monitor Calibration').

Drill four holes into the desk, at 4mm in diameter and to the dimensions as shown in the diagram. (Note that in the diagram the MC3.1 is viewed from above).

Pushing four screws through the underside of the desk screw the MC3.1, including the rubber feet, to the panel to secure. The screws should be M3 and have a length of 14mm plus the thickness of the panel.

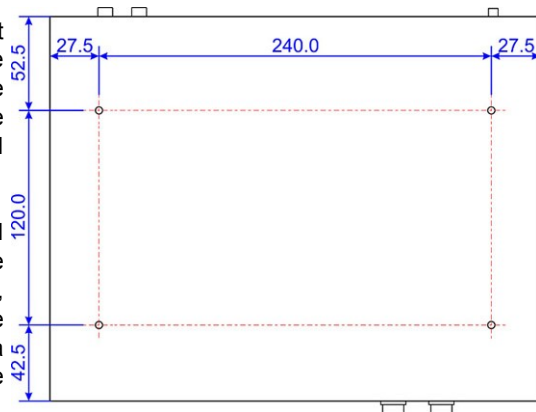

---

## POWER CONNECTION

The MC3.1 unit will be supplied with an external switching mode power supply that is capable of 100-240Vac continuous (90-264Vac max) and so should work globally. We strongly advise that the power supply that has been supplied with the MC3.1 is used, rather than one with the equivalent ratings. In addition, should the power supply fail for any reason we strongly advise that you contact Drawmer for a replacement rather than repairing the unit yourselves. Failure to do either of these could permanently damage the MC3.1 and will also invalidate the warranty.

The power supply will be supplied with cable suitable for domestic power outlets in your country. For your own safety, it is important that you use this cable to connect to the mains supply earth. The cable must not be tampered with or modified.

Before connecting the MC3.1 to the power supply ensure that all knobs are turned off (i.e. fully anticlockwise) and that the Level Switch just below the main volume control is set to Knob. A switch next to the d.c. power inlet on the rear of the unit switches the power on/off.

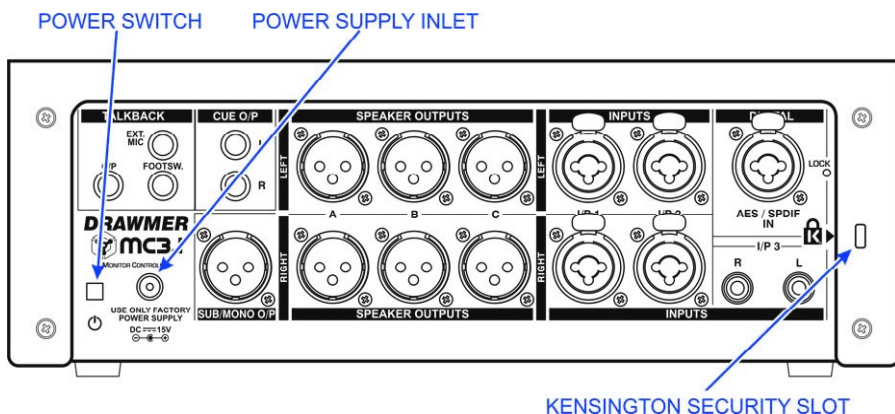

---

## SECURITY

To help protect the MC3.1 from theft the rear has a Kensington Security Slot (also called a K-Slot) which enables the fitting of hardware locking accessories that can attach your MC3.1 to an immovable object, making the MC3.1 more of a challenge for the potential thieves to steal.

---

## PORTABLE APPLIANCE TESTING

To undergo a Portable Appliance Testing procedure (commonly known as "PAT", "PAT Inspection" or "PAT Testing") use any one of the screws that hold the feet to the bottom of the unit. These screws connect directly to the chassis and provide the earthing point. If required, the foot can be removed and the cavity probed, or the screw can be replaced for something more suited to the job, such as a spade terminal with a M3 thread.

## AUDIO CONNECTIONS

**XLR - OUTPUT (MALE)**

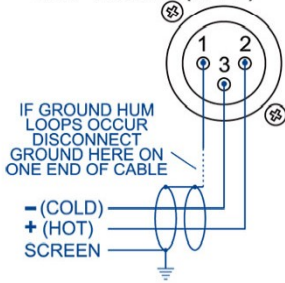

**XLR - INPUT (FEMALE)**

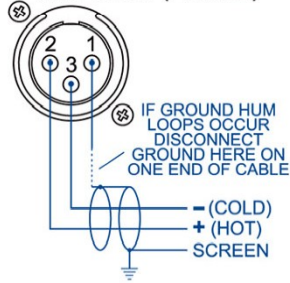

**1/4" JACK - BALANCED MONO**

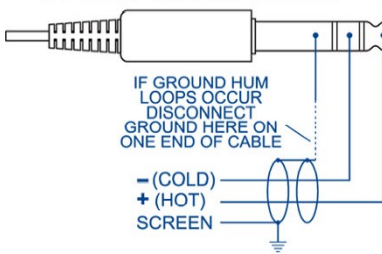

**1/4" TALK BACK JACK - UNBALANCED MONO**

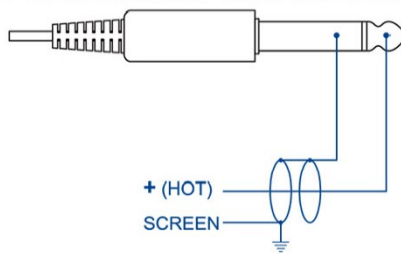

**1/4" STEREO HEADPHONE JACK**

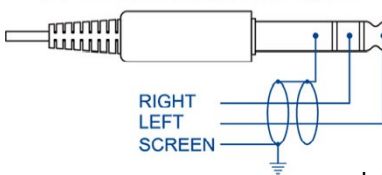

**1/4" S/PDIF JACK**

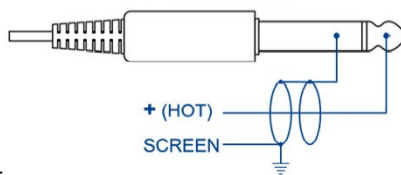

**3.5mm STEREO AUX JACK**

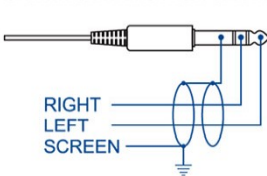

**RCA (PHONO) JACK**

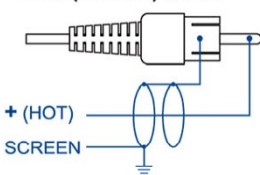

• **Interference:**

If the unit is to be used where it may be exposed to high levels of disturbance such as found close to a TV or radio transmitter, we advise that the unit is operated in a balanced configuration. The screens of the signal cables should be connected to the chassis connection on the XLR connector as opposed to connecting to pin 1. The MC3.1 conforms to the EMC standards.

• **Ground Loops:**

If ground loop problems are encountered, never disconnect the mains earth, but instead, try disconnecting the signal screen on one end of each of the cables connecting the outputs of the MC3.1 to the patchbay. If such measures are necessary, balanced operation is recommended.



# TYPICAL CONNECTION GUIDE

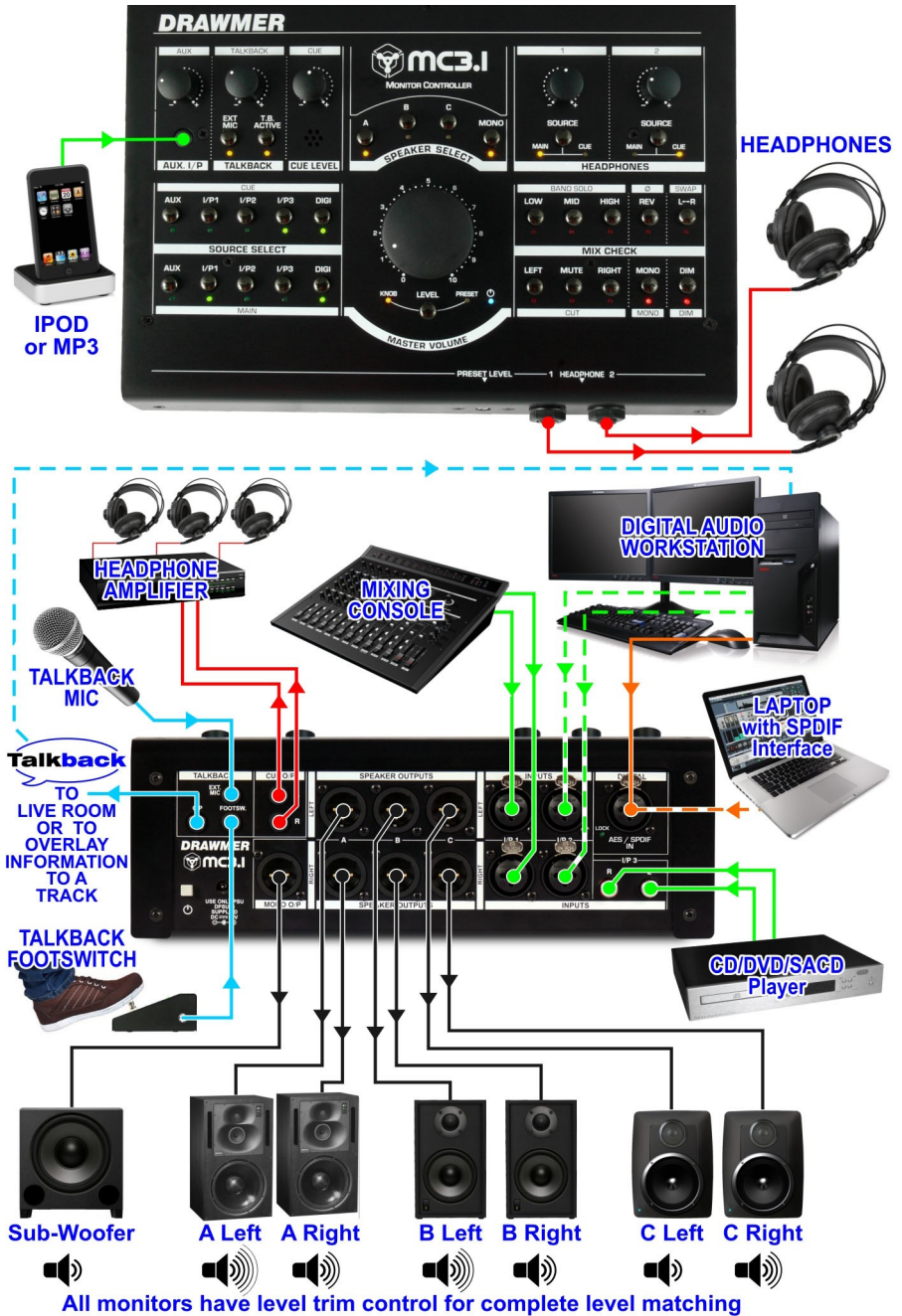

**CONTROL DESCRIPTION**

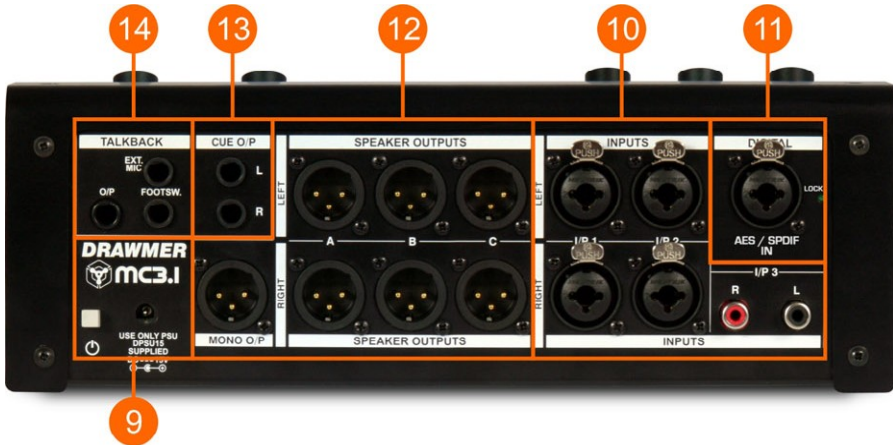

---

## The MC3.1 Controls

### 1 SOURCE SELECT

Comprises of two sections: the **MAIN** (which is routed through the Main Volume control 6) and to the Speaker Outputs 12) and/or Headphones, and **CUE** (which is routed through the Cue Level 3) and to the Cue Output 13) and/or Headphones. Five switches select which of **AUX** 2), **I/P1**, **I/P2**, **I/P3** 10) and **DIGI** 11) inputs are heard. Each can be operated individually or simultaneously and in any combination. When operated simultaneously the individual signals are summed into a single stereo signal. Note that the MC3.1 does not provide individual level trims for the inputs and so any level matching should be applied before it reaches the MC3.1.

### 2 AUX I/P

A 3.5mm stereo jack input is located on the front panel to allow easy access to connect a MP3 player, smartphone or similar audio device. A control knob allows the adjustment of the **AUX** volume to match the system level. The **AUX** input is toggled on/off via the switches in the **Source Select** section 1).

### 3 CUE LEVEL

The **CUE LEVEL** control adjusts the signal level of both stereo channels of the CUE Mix for the **CUE O/P** 13) found on the rear panel, and does not have a bearing on any other output, such as the headphones or talkback.

### 4 TALKBACK

The MC3.1 has a dedicated talkback function including inbuilt microphone, external microphone port, gain level control and external footswitch connector.

**External Mic Switch:** When active disengages the inbuilt front panel microphone and routes the operator's voice through an external microphone (not supplied), which is plugged into the rear panel (see 14).

**Talkback Active Switch:** When active engages either the inbuilt or external microphone and routes the operator's voice through the headphones and also to the talkback and CUE outputs on the rear of the unit. The switch is non-latching and so must be held in to be active. If preferred a footswitch can be connected at the rear that does the same job (see 14).

**Talkback Level.** The knob adjusts the gain level of the talkback microphone. It can be adjusted to compensate for the distance that the operator is from the microphone, how loud his voice is, or the volume of the underlying music played, as well as several other factors.

**TalkBack Microphone.** An electret condenser microphone has been incorporated into the MC3.1 and is located below the CUE Level on the front panel.

Activating the Talkback automatically engages the Dim switch (i.e. attenuates the volume by 20dB) for the headphones 7) and also the speaker outputs 12) making it possible for the artist to clearly hear the instruction.

As well as the headphones the talkback signal is also routed to the CUE output (13) and direct talkback output jack on the rear of the unit 14) to be routed at the engineers discretion.

# DRAWMER

## 5 SPEAKERS

Four switches select which of the four speaker outputs **A, B, C** or **SUB** are heard (see 12).

Each switch can be operated individually or simultaneously and in any combination and is perfect for performing A/B comparisons between various monitor setups. As the switches do not toggle between outputs when doing A/B comparisons both of those switches should be pressed at the same time i.e. to compare speakers A and C, with A active press both the A and C switches to swap the output to C active, and then again to return to the previous setting - this method can be used between all four outputs if required.

An additional benefit is derived when using a sub-bass. If the sub-bass is attached to the SUB/MONO output on the rear of the MC3.1, outputs A and B could deliver the higher frequencies and allow for A/B (or in this case A+Sub/B+Sub) comparisons between the two monitor setups by pressing the A and B switches simultaneously and leaving SUB always active. In addition, a full frequency range monitor could be attached to C, so, with the C switch active SUB should be disengaged.

Note that each speaker output has individual level trimming on the base of the unit so that precise monitor level matching can be achieved - see sections 15 and also the 'Monitor Calibration' section.

## 6 MASTER VOLUME

The Monitor Volume control adjusts the signal level of both stereo channels for all speaker outputs. The Volume knob affects the volume of the monitors A,B,C and SUB only and does not have a bearing on any other output such as the headphones or talkback jack.

A secondary preset volume control on the front edge provides a repeatable calibrated output level for the monitors, so that at the press of the switch just below the main volume knob the engineer can hear the mix at the same predetermined volume, time after time, without having to meticulously adjust controls. Once the system is calibrated (see Monitor Calibration chapter) the predetermined level could be set via a screwdriver to the maximum listening level, 85dB in the case of TV, film and music, for example, or to a standard listening level for radio, or even a preferred level for quiet passage. The level chosen is at the discretion of the operator.



---

Both the volume knob and preset control circuit designs incorporate identical paralleled custom quad potentiometers, for excellent channel matching and a smooth feel, with a range from Off (-infinity) to +12dB of gain.

Because the circuitry is active it allows for the signal level to be increased, rather than only attenuated, making subtle problems within the mix (such as noise at low levels, or unwanted harmonics, for example) more obvious and easier to iron out, especially during musical passages that would normally be quiet.

Before you can make full effective use of the Volume control it is necessary to calibrate the entire monitoring system (see the 'Monitor Calibration' section) - this allows for accurate level control, as well as left/right balance throughout the knob's range. Note that the actual output levels, including the maximum output level and the position of unity gain (0dB) around the knob, will alter depending on the calibration of the monitors.

**WARNING:**

It is recommended that you turn the volume control down to a lower level before turning the MC3.1 off - this is to ensure that a sudden volume increase when turning on does not damage your speakers or your hearing

In addition, do not use excessive force at either end of the volume knob - it's size would mean that damaging the potentiometer is possible.

A POWER LED is located within this section and when lit indicates that the unit is switched on. To turn the MC3.1 on see the mains input section .

## 7 HEADPHONES

The MC3.1 has two dedicated headphone outputs, via 1/4" TRS jacks located on the front edge, each with individual source select and level control - Note that they have their own level control and are not affected by the main monitor volume knob.

**Headphone Source:** The source of each of the headphone inputs can be switched between the Main Source and the Cue Source, allowing the engineer to listen to a completely difference mix to the artist using the headphones, for example.

In addition, note that the headphones are not always affected by the switches in the same way as the monitor outputs. The **Source** Controls (**AUX, I/P1, I/P2, I/P3 and DIGI.**) and **Mix Check** controls (**Phase Rev, Mono, Dim, Band Solo & Swap**) affect the headphones in just the same way as the speakers, however, the **Mute** and **L/R Cut** switches affect them differently (see below).

**Warning:**

It is advisable to unplug the headphones before switching the MC3.1 on or off. It is also recommended that you turn the headphone level down before inserting the jack, and turn it up to your desired listening level - these measures will not only prevent your ears from being damaged but also the headphone's drivers. Also, note that these are high quality circuits and have been designed for professional headphones, so care must be taken when using lower standard, consumer quality headphones, such as earbuds or ipod phones etc, as damage could occur.

# DRAWMER

## 8 MIX CHECKING

The **Mix Checking** section allows the engineer to test various aspects of the mix without having to alter the signal earlier in the chain and potentially effect the recording, and is a very thorough and versatile checking tool. The switches are especially useful when used in conjunction with each other.

In addition to the mix checking switches found on the MC2.1 the MC3.1 also incorporates **Band Solo** and **L/R Swap** switches.



**Band Solo:** The three switches allow the engineer to easily solo the **Low, Mid** and **High** frequencies of the stereo mix. This helps to pinpoint problems occurring at particularly frequencies or to check for unwanted signal artefacts that may bleed into each band, for example.

Each switch can be used in conjunction with each other and in any order. However, it is not recommended that all three Band Solo switches are active simultaneously as this will effect the signal at the crossover frequencies. For this very reason the MC3.1 has been designed so that with no Band Solo switches active the entire Band Solo circuit is completely relay bypassed.

**Phase Reverse:** Inverts the polarity of the signal on the Left Channel and is used primarily to outline any phase problems that may be occurring in the mix/recording such as phase cancellation, or an unbalanced stereo signal. As the switch is toggled any phase issues will become more apparent and easier to identify.

**Left/Right Swap:** Swaps the Left and Right channels of the stereo signal. It is particularly useful when checking for shifts in the stereo balance of the mix.

Under the **Cut** heading three switches have been incorporated - **Left Cut, Mute** and **Right Cut**.

**Left Cut:** Mutes the Left channel signal allowing only the right signal to be heard,  
**Right Cut:** Mutes the Right channel signal allowing only the left signal to be heard,  
**Mute:** Cuts both channels (especially useful in an emergency). If Left Cut and Right Cut are both active it is just the same as Mute being active.

Note that **Cut/Mute** does not affect the headphones (see 7) in the same way as it does the speakers (see 12). With the **Mute** switch active the headphones will still pass audio in just the same way as if it was off, they are not affected. This allows for someone to edit audio using headphones whilst a conversation is occurring in the control room, for example.

Also, note that, when activating **Left** or **Right Cut** whilst using headphones the signal is not 100% panned one way or the other - i.e. the signal centre moves to the side but is not completely removed from the opposite ear of the headphone - this is so that the **Left/Right Cut** sounds a little more natural, after all, if listening through speakers with only the left speaker active some of the signal will reach the right ear a few milliseconds later.

**Mono:** With the switch active both Left and Right stereo signals are combined into a single mono signal.

It is necessary when testing the audio to not only listen to the signal in stereo but also in mono. It helps to outline problems in the mix, but also when testing for use on non-standard applications such as for broadcast or mobile phone.

**Dim:** With the switch active the output level is attenuated by 20dB's. It enables you to lower the volume without adjusting any of the settings.

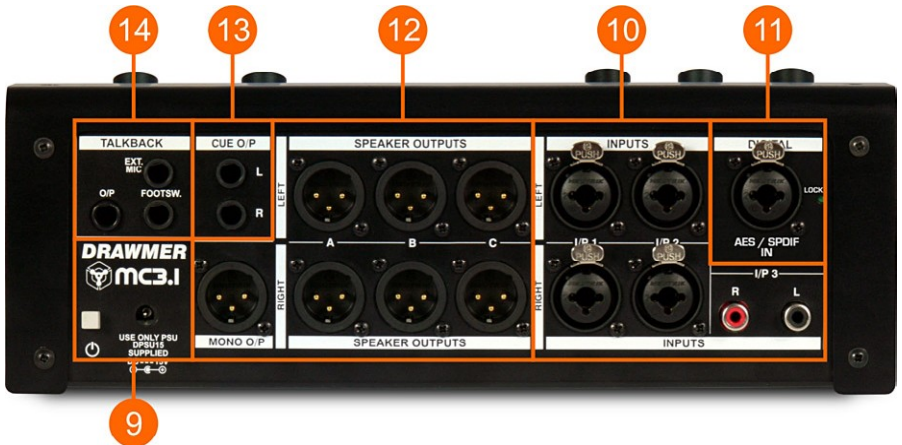

## 9 POWER

The MC3.1 will be supplied with an external switching mode power supply that is capable of 100-240Vac continuous (90-264Vac max) and so should work globally, but is supplied with a cable suitable for domestic power outlets in your country. We strongly advise that the power supply that has been supplied with the MC3.1 is used, rather than one with the equivalent ratings. The push button switch turns the MC3.1 on/off. (see Power Connection).

Note that a timed relay protection circuit has been incorporated into the MC3.1 to prevent bangs and other potentially harmful artifacts from occurring during power up and power down.

# DRAWMER

---

## 10 INPUTS ANALOGUE

The MC3.1 has four analogue inputs comprising **I/P1** & **I/P2** - both balanced Neutrik XLR/jack combi (combining a 3 pole XLR receptacle and ¼" phone jack in one XLR housing), **I/P3** - stereo RCA's, and also **AUX.** - a 3.5mm stereo jack found on the front panel (see ② & 'Audio Connections').

## 11 DIGITAL

In addition to the four analogue inputs the MC3.1 has a combined AES & SPDIF Digital input (upto 192kHz) via a Neutrik XLR (AES)/jack (SPDIF) combi.

The AES is designed to be used with standard 100 ohm balanced microphone cable with a recommended maximum length of 20m. Having many short cables joined together is not advisable as each connector can cause undesirable signal reflections.

The SPDIF is via 75 ohm cable with a 1/4" jack, where the data conforms to the Sony™ Phillips™ Digital InterFace format. Because this connector only provides an unbalanced termination, the recommended maximum length for this cable is 3 metres, even with very high quality cable. ('Audio Connections')

Each input is activated by the **Source** switches (see ①)

## 12 OUTPUTS

Three stereo balanced speaker outputs- **A**, **B** and **C**, plus a dedicated mono speaker/sub-woofer output - **SUB/MONO** - are found on the rear of the unit, all in the form of Neutrik 3 pin XLR's. Each of these outputs has an individual Left/Right/Mono trim potentiometer on the underside of the unit to enable easy and accurate monitor level/room matching throughout (see 'Monitor Calibration').

Each output is activated by the **Speakers** switches (see ⑤) - and can be activated individually or simultaneously and in any configuration.

## 13 CUE O/P

The CUE mix is usually sent to a headphone amplifier to provide for the artist with audio whilst recording. The MC3.1's dedicated CUE output is located on the rear, comprising two dual L/R 1/4" mono jacks. The mix is derived from the Cue Source Select (③) and the volume is controlled by the Cue Level (①). When talkback is active it is mixed into the CUE output.

## 14 TALKBACK

A **TALKBACK OUTPUT**, **EXTERNAL FOOTSWITCH** and **EXTERNAL MICROPHONE** connectors can be found on the rear panel, in the form of ¼" jacks.

**EXTERNAL MICROPHONE:** An external microphone can be connected to provide a more convenient location for the talkback. It is amplified by the inbuilt preamp circuitry with the volume level controlled via the Talkback Volume knob (④), however, phantom power is not supplied so a dynamic microphone should be used. To operate set the EXT MIC switch (④) to active - this will bypass the MC3.1 onboard mic.



**EXTERNAL FOOTSWITCH:** An external foot or hand switch can be connected to allow easier talkback operation. This works in parallel to the front panel switch ( 4 ) so when either are active the talkback will operate.

**TALKBACK OUTPUT:** A dedicated talkback output is provided so that, as well as being routed through the cue and the headphones, a talkback signal can be routed to other devices at the engineers discretion. This could usually be patched into the live-room active monitor speakers for convenience when recording acoustic ensembles where the performers may not wish or need to wear headphones. The output also allows for routing into a separate channel of a DAW, or other recording facility, to allow for information overdubs to be added to a recording.

### 15) SPEAKER CALIBRATION TRIM CONTROLS

On the underside of the MC3.1 there are seven rotary controls that allow the individual speaker level calibration of your system. Each speaker output has a control, including the mono/sub. To alter the speaker level use a small screwdriver to turn - counter-clockwise turns the speaker level down, and clockwise up.

For the calibration process see the “Monitor Calibration” section of this manual. Once the system has been calibrated these trims should not be touched.



## MONITOR CALIBRATION

Whether you are installing one, two or three sets of speakers it is imperative that your system is calibrated, not only to centre the stereo image and to ensure that all speaker levels are the same, but also to ensure that you are mixing your music at industry standard listening levels. The MC3.1 can calibrate the speakers of any system as it has individual rotary level trim controls for every speaker attached (found on the underside of the product).

The following method is by no means the only way to calibrate your system, and a quick look on the internet will soon find many others, but is a good starting point.

Before beginning the procedure there are a couple of things that you will require:

### Sound Pressure Level (SPL) Meter:

Unfortunately, it is virtually impossible to measure the level of sound from each speaker by ears alone. A good instrument that does a more accurate job is a Sound Pressure Level meter.

SPL Meters come in two varieties: with an analog meter or with a digital display, either works well, just choose your preferred type. You can purchase an SPL meter from most electronic stores, or search the internet in stores such as Amazon, with prices ranging from £25 to £800. Radio Shack is a good source for reasonably priced SPL meters in the USA, though to get better results, you may consider a more expensive SPL meter, such as Galaxy, Gold Line, Nady, etc.

The ideal meter should have the industry standard “C-weighted” curve, slow setting. Refer to your meter’s manual to learn how to select these settings.

If all else fails there are iPhone/Android apps that claim to be SPL meters - whilst these are nowhere near the quality of a dedicated meter they are better than nothing.



### Test files:

Test tones can either be generated through your DAW (such as the Signal Generator plug-in in Pro Tools), but you can also download test/calibration files from the internet if you search around: wav files are preferred to mp3's due to the compression/limited frequency range of mp3's. You can also purchase good quality reference CD's/DVD's from various stores.

The tones required for this calibration process are:

1. 40Hz to 80Hz bandwidth limited pink-noise file recorded at -20dBFS.
2. 500Hz to 2500Hz bandwidth limited pink-noise file recorded at -20dBFS.
3. Full-bandwidth pink-noise file recorded at -20dBFS.

**Holding the SPL** - Set the meter to C weighted and on the slow scale. Start by sitting in your normal mixing position, hold the SPL meter at arm's length and at chest level with the microphone of the meter facing toward the monitor to be calibrated. Maintain this position throughout the calibration process - this could be easier if it is fixed via a stand and bracket, and moved only to point at the relevant speaker.

The following method sets the sound pressure level to 85dB - the standard listening level for film, tv and music, however, due to the sound being altered by the size of the room, this can alter, essentially, the smaller your room is, the lower your listening level should be, down to around 76dB. The following table should give an idea of the sound pressure level to use for your environment.

Room Size		SPL Reading
Cubic Feet	Cubic Metres	
>20,000	>566	85dB
10,000 to 19,999	283 to 565	82dB
5,000 to 9,999	142 to 282	80dB
1,500 to 4,999	42 to 141	78dB
<1,499	<41	76dB

Listening at appropriate levels for your specific environment will help maintain the integrity of your mixes as they move from one system to another, in rooms of varying sizes.

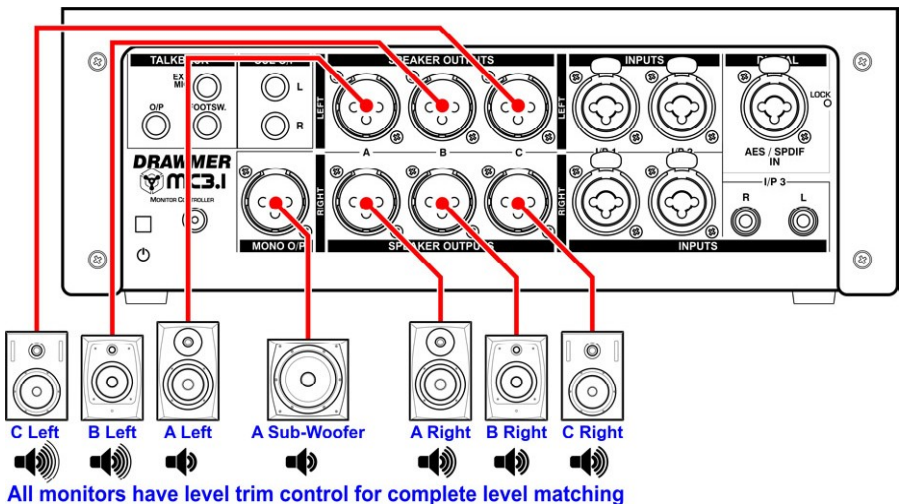

# DRAWMER

## The Procedure:

1. Begin by turning off the monitoring system and ensuring that all inputs and speakers are correctly connected.
2. Set all DAW/System controls to 0dB/unity gain - this should be left at this setting from now on. Remove all e.q. and dynamics from the signal path.
3. If you have active speakers with their own level control, or speakers with an amplifier, set all of these to maximum, so that they do not attenuate the signal.
4. On the underside of the MC3.1 you will find the speaker calibration trims - using a screwdriver initially set all of them to their full attenuation position by rotating each fully counter-clockwise. (See photo, opposite page).
5. With the Master Volume switch set the 'Knob' (6) set the large volume on the front of the MC3.1 to 12 o'clock and leave it there throughout the calibration procedure - this will be the position that provides the 85dB listening level from now on.
6. Turn the system on and play the 500 Hz – 2.5 kHz bandwidth-limited pink noise at -20 dBFS. Select the required Source on the front of the MC3.1 - I/P1, I/P2, I/P3, AUX or DIGI. You should not hear it, yet.

7. Activate the A Speaker by having only the Speaker A switch active in the speakers section on the front panel.

8. In order to hear only the Left A speaker remove the right speaker by activating the Right Cut switch.

9. On the underside of the MC3.1 rotate the Left A trim clockwise. You will now start to hear the signal, but only for that speaker. Rotate until the SPL meter reads 85dB.

10. In order to hear only the Right A speaker switch in Left Cut and deactivate the Right Cut.

11. On the underside of the MC3.1 rotate the Right A trim clockwise until the SPL meter reads the desired level.

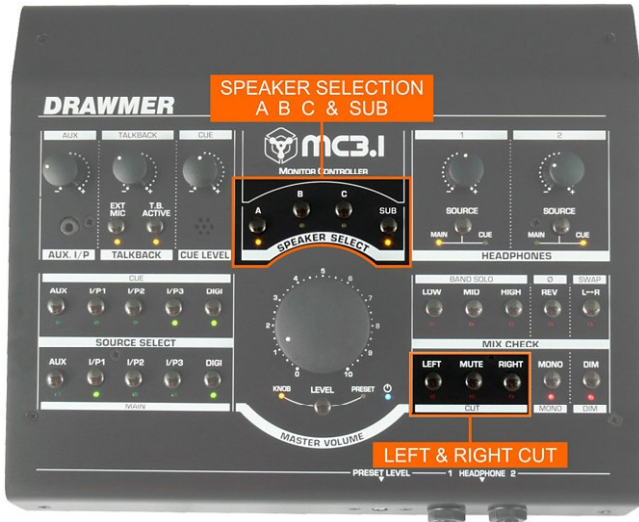

12. To calibrate each speaker repeat steps 7 to 11 - replacing the speaker on step 7 for each set - A,B or C.

13. To calibrate the sub - play the 40-80Hz signal, but this time have only the SUB switch active - Left and Right Cut need not be active as the frequency of the signal is limited to only the sub.

14. On the underside of the MC3.1 increase the Mono trim increasing the volume of the sub until the desired SPL meter reading is reached.

15. Repeat steps 7 to 12 whilst playing the full bandwidth pink noise and adjusting to suit. The readings should be pretty close and only require fine adjustment.

16. Now the system is calibrated it is time to set the **PRESET** volume control. Set the Master Volume switch to 'PRESET' (6) and with only one set of speakers active in the Speaker Select switches (5) adjust the preset level on the front of the MC3.1 using a screwdriver until the SPL meter reads your desired listening level.



16. You are finished and the calibration process has been completed.

The volume control will have a few dB's of headroom so care must be taken to both your hearing and system when increasing the volume passed the 12 o'clock position. As with all things that are calibrated it's a good idea to regularly check the calibration of your monitors to ensure that nothing has changed.



## **Mix Checking Tips**

Due to the versatility of the MC3.1, and its thorough array of controls, some very useful techniques for checking your mix can easily be achieved, that can help improve the balance within a mix, pinpoint stereo width, phase and mono problems, and also aid when monogising.

The following are a few handy tips to help eradicate problems and bring about a balance within the mix:

### **Not too loud**

Give your ears a break. Do not have the volume too loud - frequent monitoring at anything above 90dB will only make your ears tired, meaning that you won't really hear the problems that may be occurring, and give you a false sense that the mix sounds nice and loud. Also, constant listening at anything above 100dB will probably have a long term detrimental effect on your hearing.

### **Shhhh...**

Get into a habit of listening to your mix at very low levels quite often. Remember that not everyone listening to your song has music blasting out. As well as giving your ears a break, it will heighten problems in the mix - Do the key elements have a good balance, or are some instruments more prominent than they should be? If something is too quiet or loud adjust its volume or use E.Q. to fix it. If the mix sounds good at low levels it's likely that it will when loud.

Note that on the MC3.1 it is better to lower the volume level using the DIM switch and then turn the volume up, rather than only turning the volume down, as you maintain greater control over the volume as well as better left/right channel matching.

### **Increase the Volume of Quiet Passages.**

Because the MC3.1 circuitry is active it allows for the signal level to be increased, rather than only attenuated, making subtle problems within the mix, such as noise at low levels, or unwanted harmonics, more obvious and easier to iron out, especially during passages that would normally be quiet.

### **Hear, There and Everywhere.....**

Listen to your mix on as many systems as possible. The three monitor outputs allows for the addition of a non standard testing setup i.e. the system could be forced to emulate low-quality domestic reproduction systems as well as car speakers or a portable radio, by incorporating limited-bandwidth speakers to output C. In such conditions you may find that an instrument drops out of the mix, or another is too prominent, and adjustment to the mix need to be made. For best results calibrate the speakers to match the output level of the rest of the system.

---

### **Cut It Out...**

Using the left and right cut switches will highlight the stereo balance of each channel. In stereo the mix sounds ok, however, it may be that you want an instrument to be panned so far left that it doesn't occur at all in the right channel, by cutting the left and only hearing the right channel you will hear whether the instrument bleeds across, and panning adjustment can be made.

### **Phase Reverse**

Make use of the phase reverse switch. If the sound doesn't become less focused when the polarity is flipped then there is something wrong somewhere. Not only will the switch help confirm that the monitor speakers are wired up in the correct polarity, phase inversion on a particular instrument can at times improve the way the instrument interacts with the rest of the mix by removing the phase cancellation.

### **Monogising**

Check your mix in mono - often! Just because a mix sounds good in stereo doesn't mean it will sound good when the left and right channels are combined. Why should you care if your mix sounds good in mono? Well, most live music venues and dance club sound systems are mono - running the PA or sound system in mono is common practice to ensure music sounds good everywhere in the room because it removes the 'sweet spot' and the complex phase issues of stereo. In many cases the low frequencies will be put through a crossover and summed to mono before being sent to the sub, such as in a home theatre system, for example. Monogising is also necessary when testing the audio for use on nonstandard applications such as for broadcast or mobile phone.

In addition, monogising will highlight phase problems. In some cases, when you activate the Mono switch you may hear comb-filtering, which will colour the sound of your mix and cause peaks and dips in its frequency response. When a stereo mix is combined into mono any elements that are out of phase will drop in level or may even disappear completely. This could be because left and right outputs are wired out of phase but its more likely to be due to phase cancellation.

What causes phase cancellation?

Many stereo widening effects and techniques, such as chorus;

Simultaneous direct box and mic recording - If you've ever recorded a guitar simultaneously through a direct box and a microphone, you may have noticed the time alignment problems this causes. This type of situation can often be fixed by careful mic placement, or realigning the waveform in a DAW;

Any situation where more than one microphone is used to record a source - on a multi-miked drumkit two mics may pick up exactly the same signal and cancel each other out. It may sound unlikely but one handy tip is to adjust the panning of your drums whilst in mono - suddenly all the phase cancellation of the drums will improve, and sound even better when reverted back to stereo.

# DRAWMER

---

Listening in mono also highlights problems with the stereo width and balance of the mix and is more apparent when you use a lot of stereo-widening or width-enhancing techniques and tools. Switching mono in and out fairly quickly may make it apparent that the centre of the mix is shifting to the left or right, something that may go unnoticed if only working in stereo.

## True Mono

As a mono signal would normally originate from a single source it would be wrong to simply activate the mono switch - as both left and right speakers are still active. When you listen to a mono signal on two speakers, you hear a false or 'phantom' image which is derived midway between the speakers, but because both speakers are contributing to the sound, the level of the bass seems to be over-inflated. To truly hear a monogised signal via one speaker (the way everyone else will hear it) the mono switch should be active but also either Left Cut or Right Cut should also be activated (depending on preference/location) to derive the signal from a single location.

## Listen to the 'Stereo difference' or side signal

A very useful facility of the MC3.1 is the ability to listen to the 'stereo difference' or side signal, very quickly and easily. The side signal is the difference between the two channels, and describes those elements that contribute to the stereo width.

Hearing the stereo difference is so simple using the MC3.1: with the stereo signal playing, activate the **Phase Reverse** switch, and then sum the left and right channels using the **Mono** switch (in other words Left-Right). It's that simple.

Being able to audition the 'side' signal is particularly useful for judging the quality and quantity of any ambience or reverberation in a stereo mix. It is also an invaluable facility if the stereo recording has timing differences between channels (such as caused by an azimuth error on a tape machine), or for aligning a pair of desk channels for use with X-Y stereo mic pairs. In both cases, listening for a deep cancellation null, as the two signals cancel each other out, is a very fast and accurate way of matching levels in each channel, which is the basis of accurate alignment.

## Going Solo

Whilst working on a mix you can get so used to hearing the entire audio as a whole that it's difficult to pinpoint any problems in certain frequency ranges, using the **low**, **mid** and **high solo** buttons can really help. A common problem within many mixes is that there is too much going on in any given frequency range leading to an unbalanced mix. Perhaps the bass is overpowering the vocals, or there is an undesirable noise somewhere that you can't quite put your finger on. Using the **solo** buttons of the MC3.1 you can easily remove the bass to hear what's going on in the mids and highs, or to hear just how the mid range panning is working, for example, and correct the mix to redress the balance.

A common problem when using high levels of compression across the mix is pumping, this can be really desirable in the case of dance music, but not elsewhere. If the majority of energy within the mix is in the bass, every time the kick drum beats it will trigger the compressor, thus lowering the volume, but not only of the bass, but across the whole mix, creating a pumping effect. Soloing the mid and high makes it very easy to hear the extent of the pumping and to rectify it if desired.



---

## Know your Left from your Right

It is useful to get into the habit of using the **Left / Right Swap** button every now and then when working on a stereo mix. We get so used to hearing a mix as it's developing that it's easy to get a stereo imbalance. If when pressing the **Swap** button the stereo image is mirrored around the centre, and you notice that it's more prominent in a certain ear then the stereo image is likely to be out of balance. If it is unclear that it has altered then the stereo mix should be balanced.

The **Swap** button also highlights problems with the monitoring system such as if piece of audio that is panned centrally but actually sounds off centre. If by pressing the button the stereo image remains the same then it shows one speaker is louder than the other and the system should be recalibrated. If the same audio is mirrored around the centre then it shows that the fault is within the mix itself.

### Active vs. Passive Circuits

There is a great debate as to which is best - a passive or active monitor control circuit. The theory is that passive monitor controllers must be best, since they do not add transformers or other components to the signal path, along with the noise and distortion that they can bring, however they have severe disadvantages over active circuits. The most significant is that the output impedance of the connected source equipment and the input impedance of the power amp or active speaker will affect the workings of the passive controller - each needs buffering to remain reliable and consistent, otherwise level matching problems will be inevitable. Since even the best cables have capacitance, it is extremely important to keep cable lengths to an absolute minimum (i.e. less than a couple of meters) to avoid signal degradation especially in high frequency signals. Long cables will act like a simple low frequency filter.

Furthermore, it is incredibly difficult to get a mono signal from a passive circuit without affecting the sound so any kind of reliable mix checking becomes near impossible.

Active designs make it easier and more reliable to guarantee a high performance level as the signal attenuation and switching is actively buffered, as well as providing complete control over distortions, crosstalk, frequency response, and transient fidelity. Moreover, cable lengths of tens of meters should not be an issue. Furthermore, it makes it possible to introduce mix checking features that would otherwise be missing. The disadvantage with active monitor controllers is that the electronics have the potential to introduce noise and distortion. Designing a clean monitor control system is far from simple, however, using only the very best components and clever circuit design, with the Drawmer MC3.1 we have overcome all of these problems and managed to combine the best of both - whilst retaining the transparency and responsiveness that a passive circuit would bring with the advantages of an active one.

**MC3.1 GENERAL INFORMATION**

**IF A FAULT DEVELOPS**

For warranty service please call Drawmer Electronics Ltd. or their nearest authorised service facility, giving full details of the difficulty. A list of all main dealers can be found on the Drawmer webpages. On receipt of this information, service or shipping instructions will be forwarded to you.

No equipment should be returned under the warranty without prior consent from Drawmer or their authorised representative.

For service claims under the warranty agreement a service Returns Authorisation (RA) number will be issued. Write this RA number in large letters in a prominent position on the shipping box. Enclose your name, address, telephone number, copy of the original sales invoice and a detailed description of the problem.

Authorised returns should be prepaid and must be insured.

All Drawmer products are packaged in specially designed containers for protection. If the unit is to be returned, the original container must be used. If this container is not available, then the equipment should be packaged in substantial shock-proof material, capable of withstanding the handling for the transit.

**CONTACTING DRAWMER**

We will be pleased to answer all application questions to enhance your usage of Drawmer equipment.

Please address correspondence to:

**DRAWMER Electronics LTD**  
Coleman Street  
Parkgate  
Rotherham  
South Yorkshire  
S62 6EL  
United Kingdom

Telephone: **+44 (0) 1709 527574**  
Fax: **+44 (0) 1709 526871**

Contact via E-mail: **tech@drawmer.com**

Further information on all Drawmer products, dealers, Authorised service departments and other contact information can be found on our website: **www.drawmer.com**

**SPECIFICATION**

**INPUT**

Maximum Input Level 27dBu

**OUTPUT**

Maximum Output Level before clipping 27dBu

**DYNAMIC RANGE**

@ unity gain 117dB

**CROSSTALK**

L/R @ 1kHz >84dB  
Adjacent Input >95dB

**THD & NOISE**

unity gain 0dBu input 0.003%

**FREQUENCY RESPONSE**

20Hz-20kHz +/- 0.2dB

**PHASE RESPONSE**

20Hz-20kHz +/- 2degrees max

**POWER REQUIREMENTS**

External Power Supply  
Input: 100-240V ~ 50-60Hz, 1.4A MAX.  
Output: 15V  4.34A  
Voltage automatically selected by PSU



Use only the external PSU supplied by Drawmer or an accredited partner. Failure to do so could permanently damage the MC3.1 and will also invalidate the warranty.

**CASE SIZE**

Depth (with Controls & Sockets) 220mm  
Width 275mm  
Height (with Feet) 100mm

**WEIGHT**

2.5kg

# BLOCK DIAGRAM

EXTERNAL POWER SUPPLY

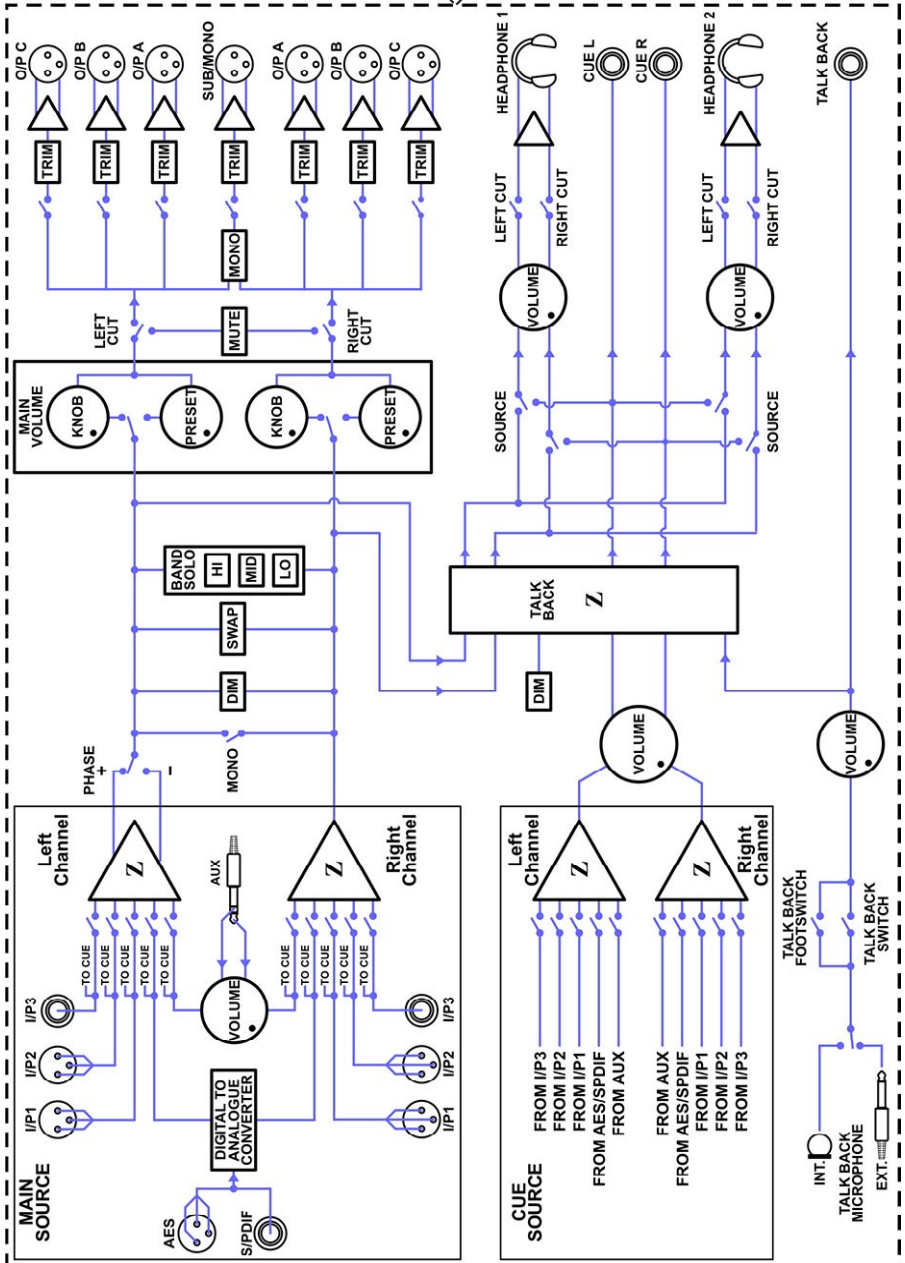

Ref:1v00 A 12-07-16

# ***DRAWMER***

Drawmer Electronics Ltd, Coleman St, Parkgate,  
Rotherham, South Yorkshire, U.K.