



  
STAIRVILLE

MBM40D DMX  
mirror ball motor

Musikhaus Thomann  
Thomann GmbH  
Hans-Thomann-Straße 1  
96138 Burgebrach  
Germany  
Telephone: +49 (0) 9546 9223-0  
E-mail: [info@thomann.de](mailto:info@thomann.de)  
Internet: [www.thomann.de](http://www.thomann.de)

13.11.2017, ID: 384315

# Table of contents

<b>1</b>	<b>General notes</b> .....	<b>4</b>
	1.1 Further information.....	5
	1.2 Notational conventions.....	6
	1.3 Symbols and signal words.....	7
<b>2</b>	<b>Safety instructions</b> .....	<b>10</b>
<b>3</b>	<b>Features</b> .....	<b>13</b>
<b>4</b>	<b>Installation and starting up</b> .....	<b>14</b>
<b>5</b>	<b>Connections and controls</b> .....	<b>19</b>
<b>6</b>	<b>Operating</b> .....	<b>24</b>
<b>7</b>	<b>Technical specifications</b> .....	<b>29</b>
<b>8</b>	<b>Plug and connection assignments</b> .....	<b>30</b>
<b>9</b>	<b>Cleaning</b> .....	<b>31</b>
<b>10</b>	<b>Protecting the environment</b> .....	<b>32</b>

# 1 General notes

This manual contains important instructions for the safe operation of the unit. Read and follow the safety instructions and all other instructions. Keep the manual for future reference. Make sure that it is available to all those using the device. If you sell the unit please make sure that the buyer also receives this manual.

Our products are subject to a process of continuous development. Thus, they are subject to change.

## 1.1 Further information

On our website ([www.thomann.de](http://www.thomann.de)) you will find lots of further information and details on the following points:

Download	This manual is also available as PDF file for you to download.
Keyword search	Use the search function in the electronic version to find the topics of interest for you quickly.
Online guides	Our online guides provide detailed information on technical basics and terms.
Personal consultation	For personal consultation please contact our technical hotline.
Service	If you have any problems with the device the customer service will gladly assist you.

## 1.2 Notational conventions

This manual uses the following notational conventions:

### Letterings

The letterings for connectors and controls are marked by square brackets and italics.

**Examples:** *[VOLUME]* control, *[Mono]* button.

### Displays

Texts and values displayed on the device are marked by quotation marks and italics.

**Examples:** *'24ch'*, *'OFF'*.

## Instructions



The individual steps of an instruction are numbered consecutively. The result of a step is indented and highlighted by an arrow.

### Example:

1. ▶ Switch on the device.
2. ▶ Press *[Auto]*.
  - ⇒ Automatic operation is started.
3. ▶ Switch off the device.

## 1.3 Symbols and signal words

In this section you will find an overview of the meaning of symbols and signal words that are used in this manual.

Signal word	Meaning
<b>DANGER!</b>	This combination of symbol and signal word indicates an immediate dangerous situation that will result in death or serious injury if it is not avoided.
<b>WARNING!</b>	This combination of symbol and signal word indicates a possible dangerous situation that can result in death or serious injury if it is not avoided.
<b>NOTICE!</b>	This combination of symbol and signal word indicates a possible dangerous situation that can result in material and environmental damage if it is not avoided.
Warning signs	Type of danger
	Warning – high-voltage.
	Warning – suspended load.



Warning signs	Type of danger
	Warning – danger zone.

## 2 Safety instructions

### Intended use

This device is designed as a drive motor for mirror balls. Use the device only as described in this user manual. Any other use or use under other operating conditions is considered to be improper and may result in personal injury or property damage. No liability will be assumed for damages resulting from improper use.

This device may be used only by persons with sufficient physical, sensorial, and intellectual abilities and having corresponding knowledge and experience. Other persons may use this device only if they are supervised or instructed by a person who is responsible for their safety.

### Safety



#### **DANGER!**

#### **Danger for children**

Ensure that plastic bags, packaging, etc. are disposed of properly and are not within reach of babies and young children. Choking hazard!

Ensure that children do not detach any small parts (e.g. knobs or the like) from the unit. They could swallow the pieces and choke!

Never let children unattended use electrical devices.



**DANGER!**

**Electric shock caused by high voltages inside**

Within the device there are areas where high voltages may be present. Never remove any covers.

There are no user-serviceable parts inside.



**DANGER!**

**Electric shock caused by short-circuit**

Do not modify the mains cable or the plug. Failure to do so could result in electric shock/death or fire. If in doubt, seek advice from a registered electrician.



**NOTICE!**

**Risk of fire**

Do not cover the device nor any ventilation slots. Do not place the device near any direct heat source. Keep the device away from naked flames.



### **NOTICE!**

#### **Operating conditions**

This device has been designed for indoor use only. To prevent damage, never expose the device to any liquid or moisture. Avoid direct sunlight, heavy dirt, and strong vibrations.



### **NOTICE!**

#### **Power supply**

Before connecting the device, ensure that the input voltage (AC outlet) matches the voltage rating of the device and that the AC outlet is protected by a residual current circuit breaker. Failure to do so could result in damage to the device and possibly injure the user.

Unplug the device before electrical storms occur and when it is unused for long periods of time to reduce the risk of electric shock or fire.

### 3 Features

- Drive motor for mirror balls
- Maximum rated weight load: 40 kg
- Operating modes: Master / slave, automatic, DMX
- Rotational direction selectable
- Rotating speed adjustable

## 4 Installation and starting up

Unpack and carefully check that there is no transportation damage before using the unit. Keep the equipment packaging. To fully protect the device against vibration, dust and moisture during transportation or storage use the original packaging or your own packaging material suitable for transport or storage, respectively.

## Ceiling installation



### **WARNING!**

#### **Risk of injury caused by falling objects**

Make sure that the ceiling installation of the motor is carried out properly, professionally and according to the standards and rules that apply in your country.

Use appropriate mounting hardware to attach the motor to the ceiling. The designated fastening area must be sufficiently stable for the load, level and vibration-free.



*The device is designed for a maximum load of 40 kg (mirror ball, fastening and safety chains, hook). Including the self-weight of the device, a maximum tensile load of 46 kg results for the fastening materials used for ceiling mounting!*

Always work from a stable platform whenever installing or servicing the unit. In doing so, the area underneath the unit must be cordoned off.

The following figure shows the drilling template for the ceiling mounting of the device.

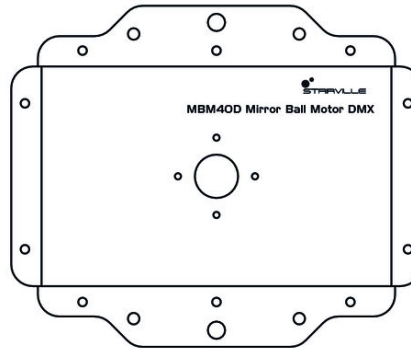

*When installed, the motor axis must be exactly perpendicular to the ceiling level!*



For information and instructions for installing the mirror ball, in particular the applicable safety instructions, please refer to the enclosed manufacturer's guide.



**NOTICE!**

**Possible data transmission errors**

For error-free operation make use of dedicated DMX cables and do not use ordinary microphone cables.

Never connect the DMX input or output to audio devices such as mixers or amplifiers.

Establish all connections as long as the unit is switched off. Use the shortest possible high-quality cables for all connections.

## Connections in DMX mode

Connect the DMX input of the device to the DMX output of a DMX controller or another DMX device. Connect the output of the first DMX device to the input of the second one, and so on to form a daisy chain. Always ensure that the output of the last DMX device in the daisy chain is terminated with a resistor ( $110\ \Omega$ ,  $\frac{1}{4}\text{ W}$ ).

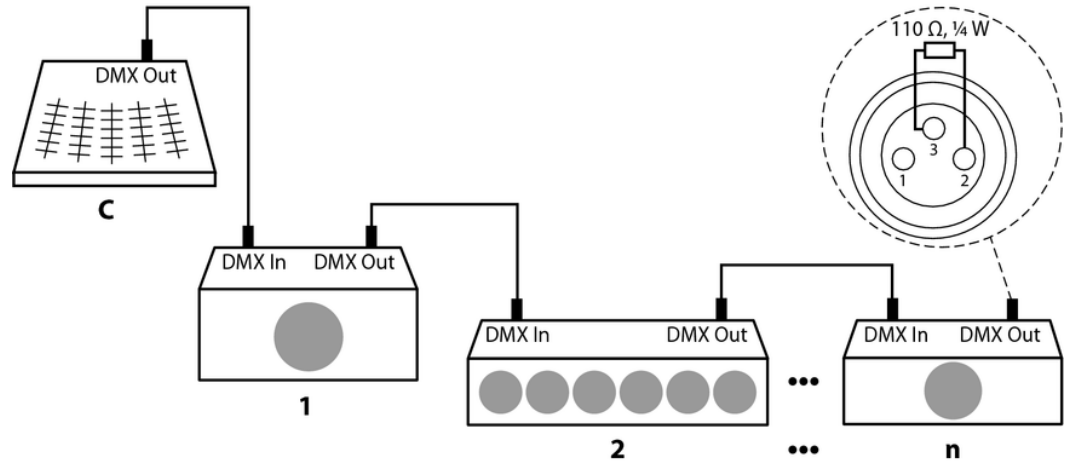

## 5 Connections and controls

Top view

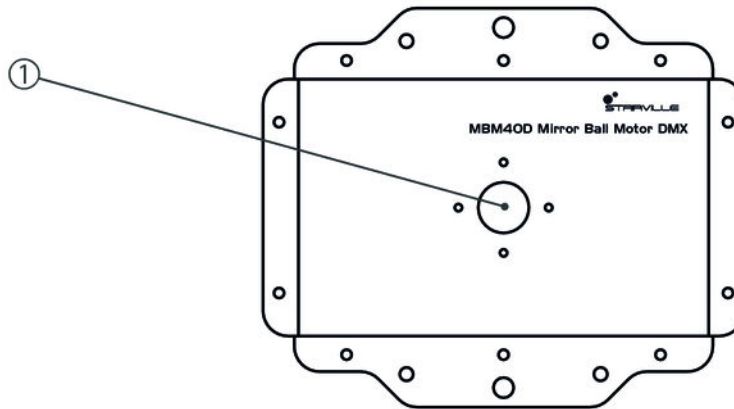

1 Motor axis.

MBM40D DMX

## Front and rear side

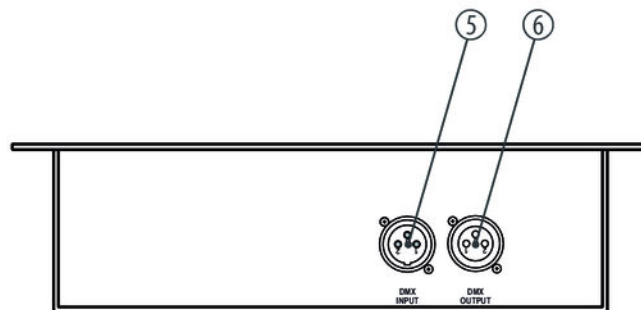
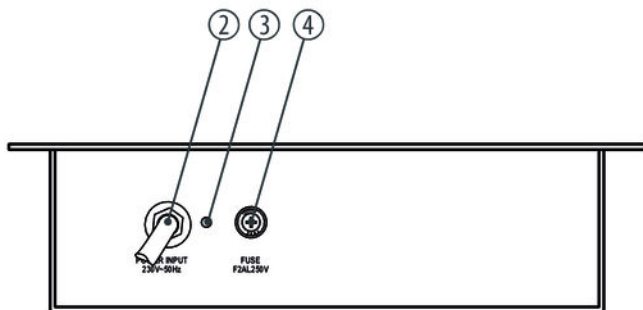

2	<i>[POWER INPUT]</i> Mains cable for power supply.
3	Power indicator. This LED lights up as soon as power is applied to the device.
4	<i>[FUSE]</i> Fuse holder.
5	<i>[DMX INPUT]</i> DMX input.
6	<i>[DMX OUTPUT]</i> DMX output.

## Control panel and display

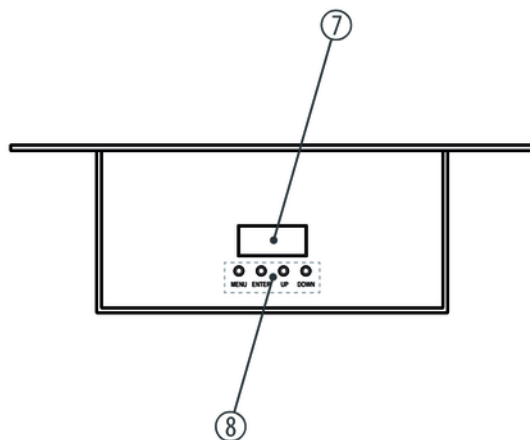

7	Display.
8	<i>[Mode]</i> Activates the main menu and toggles between menu items. Closes an opened submenu.
	<i>[Setup]</i> Selects an option of the respective operating mode, confirms the set value.
	<i>[Up]</i> Increases the displayed value by one.
	<i>[Down]</i> Decreases the displayed value by one.

## 6 Operating

### Before switching on

A suitable safety bolt is part of the delivery and is used to attach a safety chain, which must secure the attached mirror ball against falling.

Attach the safety bolt to the motor axis before turning on. When mounting the mirror ball, follow all manufacturer's advice and instructions and, in particular the applicable safety regulations.

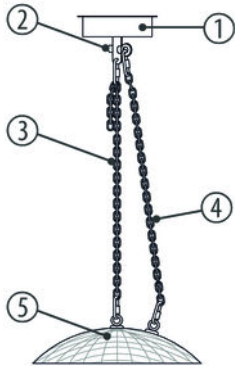

1	Mirror ball motor
2	Safety bolt.
3	Hanging chain of the mirror ball.
4	Safety chain of the mirror ball.
5	Mirror ball.



**Turning the unit on**

To start up the device, connect it to the mains. The device is immediately ready for operation.

**Operating mode 'Master / Slave'**

This setting is only relevant if the device is working as Slave in a Master / Slave configuration and is not controlled via DMX. In this operating mode, the device responds to the control signals of the master device.

- 1.** ▶ Establish all necessary cable connections.
- 2.** ▶ Use *[Menu]* to open the main menu and use *[Up]* or *[Down]* to select the option 'Slave'.
  - ⇒ The device operates in slave mode until you select another operating mode.

## Operating mode 'DMX'

This setting is only relevant when the device is controlled via DMX.

1. ➤ Use *[Menu]* to open the main menu and use *[Up]* or *[Down]* to select the option 'DMX'.
2. ➤ Confirm with *[Enter]* and use *[Up]* or *[Down]* to assign a DMX address in a range from 'A001' ... 'A512'.

Channel	Value	Function
1	0	no rotary movement
	1 ... 127	clockwise rotation movement, speed decreasing
	128	no rotary movement
	129 ... 255	counter-clockwise rotation movement, speed increasing

## Operating mode 'Automatic'

This setting is only relevant if the device is working in Stand Alone mode and is not controlled via DMX. In this operating mode, the device responds to the 'Auto' menu settings.

1. ▶ Use *[Menu]* to open the main menu and use *[Up]* or *[Down]* to select the option 'Auto'.
2. ▶ Confirm with *[Enter]* and use *[Up]* or *[Down]* to select one of the following options:
  - 'direction'
  - 'speed'
3. ▶ You can specify the rotational direction of the motor in the 'direction' menu: 'd1' (clockwise) or 'd3' (counter clockwise).
4. ▶ You can specify the rotational speed of the motor in the 'speed' menu: 'SP01' ... 'SP64' ( $0.5 \text{ min}^{-1}$  ...  $5 \text{ min}^{-1}$ ).

**Menu overview**

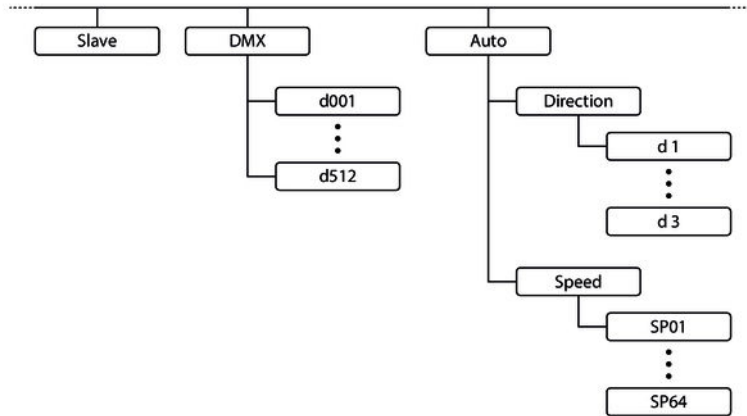

## 7 Technical specifications

Number of DMX channels	1
Rotational speed	adjustable from 0.5 min <sup>-1</sup> ... 5 min <sup>-1</sup>
Rotational direction	right / left switchable
Mechanical resilience	40 kg (maximum tensile load in vertical direction)
Power consumption	16 W
Operating supply voltage	AC 230 V ~ 50 Hz
Fuse	5 mm × 20 mm, 2 A, 250 V, slow-blow
Dimensions (W × H × D)	285 mm × 190 mm × 235 mm
Weight	6 kg

## 8 Plug and connection assignments

### Introduction

This chapter will help you select the right cables and plugs to connect your valuable equipment so that a perfect light experience is guaranteed.

Please take our tips, because especially in 'Sound & Light' caution is indicated: Even if a plug fits into a socket, the result of an incorrect connection may be a destroyed DMX controller, a short circuit or 'just' a not working light show!

### DMX connections

The unit offers a 3-pin XLR socket for DMX output and a 3-pin XLR plug for DMX input. Please refer to the drawing and table below for the pin assignment of a suitable XLR plug.



Pin	Configuration
1	Ground, shielding
2	Signal inverted (DMX-, 'cold signal')
3	Signal (DMX+, 'hot signal')

## 9 Cleaning

### Components

Clean the externally accessible device parts regularly. The frequency of cleaning depends on the operating environment: wet, smoky or particularly dirty surroundings can cause more accumulation of dirt on the device parts.

- Clean with a soft dry cloth.
- Stubborn stains may be removed with a slightly damp cloth.
- Never use cleaners containing alcohol or thinner.

## 10 Protecting the environment

### Disposal of the packaging material



For the transport and protective packaging, environmentally friendly materials have been chosen that can be supplied to normal recycling.

Ensure that plastic bags, packaging, etc. are properly disposed of.

Do not just dispose of these materials with your normal household waste, but make sure that they are collected for recycling. Please follow the notes and markings on the packaging.

### Disposal of your old device



This product is subject to the European Waste Electrical and Electronic Equipment Directive (WEEE). Do not dispose with your normal household waste.

Dispose of this device through an approved waste disposal firm or through your local waste facility. When discarding the device, comply with the rules and regulations that apply in your country. If in doubt, consult your local waste disposal facility.



MBM40D DMX





