

DRAWMER

1978



STEREO TONE SHAPING FET COMPRESSOR

OPERATOR'S MANUAL

CONTENTS

Warranty	2
Safety Consideration	2
<i>Chapter 1 - Introduction</i>	
Introduction	3
Installation	4
Audio Connections	4
Power Connection	5
<i>Chapter 2 - Control Description</i>	
Control Description	6
<i>Chapter 3 - General Information</i>	
If a fault develops	9
Contacting Drawmer	9
Specification	9
Block Diagram	10

COPYRIGHT

This manual is copyrighted © 2015 by Drawmer Electronics Ltd. With all rights reserved. Under copyright laws, no part of this publication may be reproduced, transmitted, stored in a retrieval system or translated into any language in any form by any means, mechanical, optical, electronic, recording, or otherwise, without the written permission of Drawmer Electronics Ltd.

ONE YEAR LIMITED WARRANTY

Drawmer Electronics Ltd., warrants the Drawmer 1978 Stereo Tone Shaping FET Compressor to conform substantially to the specifications of this manual for a period of one year from the original date of purchase when used in accordance with the specifications detailed in this manual. In the case of a valid warranty claim, your sole and exclusive remedy and Drawmer's entire liability under any theory of liability will be to, at Drawmer's discretion, repair or replace the product without charge, or, if not possible, to refund the purchase price to you. This warranty is not transferable. It applies only to the original purchaser of the product.

For warranty service please call your local Drawmer dealer. Alternatively call Drawmer Electronics Ltd. at +44 (0)1709 527574. Then ship the defective product, with transportation and insurance charges pre-paid, to Drawmer Electronics Ltd., Coleman Street, Parkgate, Rotherham, S62 6EL UK. Write the RA number in large letters in a prominent position on the shipping box. Enclose your name, address, telephone number, copy of the original sales invoice and a detailed description of the problem. Drawmer will not accept responsibility for loss or damage during transit.

This warranty is void if the product has been damaged by misuse, modification or unauthorised repair.

THIS WARRANTY IS IN LIEU OF ALL WARRANTIES, WHETHER ORAL OR WRITTEN, EXPRESSED, IMPLIED OR STATUTORY. DRAWMER MAKES NO OTHER WARRANTY EITHER EXPRESS OR IMPLIED, INCLUDING, WITHOUT LIMITATION, ANY IMPLIED WARRANTIES OF MERCHANTABILITY, FITNESS FOR A PARTICULAR PURPOSE, OR NON-INFRINGEMENT. PURCHASER'S SOLE AND EXCLUSIVE REMEDY UNDER THIS WARRANTY SHALL BE REPAIR OR REPLACEMENT AS SPECIFIED HEREIN.

IN NO EVENT WILL DRAWMER ELECTRONICS LTD. BE LIABLE FOR ANY DIRECT, INDIRECT, SPECIAL, INCIDENTAL OR CONSEQUENTIAL DAMAGES RESULTING FROM ANY DEFECT IN THE PRODUCT, INCLUDING LOST PROFITS, DAMAGE TO PROPERTY, AND, TO THE EXTENT PERMITTED BY LAW, DAMAGE FOR PERSONAL INJURY, EVEN IF DRAWMER HAS BEEN ADVISED OF THE POSSIBILITY OF SUCH DAMAGES.

Some states and specific countries do not allow the exclusion of implied warranties or limitations on how long an implied warranty may last, so the above limitations may not apply to you. This warranty gives you specific legal rights. You may have additional rights that vary from state to state, and country to country.

DRAWMER

1978

Stereo Tone Shaping FET Compressor

SAFETY CONSIDERATIONS

CAUTION - MAINS FUSE

TO REDUCE THE RISK OF FIRE
REPLACE THE MAINS FUSE ONLY WITH
A FUSE THAT **CONFORMS TO IEC127-2.**
250 VOLT WORKING, TIME DELAY TYPE
AND BODY SIZE OF 20mm x 5mm.
THE MAINS INPUT FUSE MUST BE
RATED AT 230V=T160mA and 115V=T315mA.

CAUTION - MAINS CABLE

DO NOT ATTEMPT TO CHANGE
OR TAMPER WITH THE
SUPPLIED MAINS CABLE.

CAUTION - SERVICING

DO NOT PERFORM ANY SERVICING.
REFER ALL SERVICING TO QUALIFIED
SERVICE PERSONNEL.

WARNING

TO REDUCE THE RISK OF FIRE OR
ELECTRIC SHOCK DO NOT EXPOSE
THIS EQUIPMENT TO RAIN OR MOISTURE.



In the interests of product development, Drawmer reserve the right to modify or improve specifications of this product at any time, without prior notice.

DRAWMER 1978

STEREO TONE SHAPING FET COMPRESSOR



INTRODUCTION

The Drawmer 1978 builds on the success of the award winning 1973 multiband FET compressor and adorns an unparalleled array of controls to give complete mastering over your mix, and all in a deceptively simple 1U frame.

In addition to the usual Ratio, Threshold, Attack and Release controls, the 1978 features four character switches offering a wide range of compression flavours, as well as a variable saturation control to add harmonic distortion to the signal. Side chain functionality is also included with side chain insert points on both channels and a very comprehensive and flexible Side Chain EQ section which offers LF and HF controls with a choice of specific shapes and frequencies for precise frequency-conscious compression such as de-essing. A wet/mix control also allows you to blend the processed signal with the dry for parallel compression.

In addition, a fast reacting Dual colour backlit VU Meter is employed to provide a visual indication of the amount of saturation added. Time delay relays are incorporated into the outputs to provide clean power-up and down with no pops or bangs, and a low hum toroidal linear power supply. The Drawmer 1978 is a truly flexible compressor made in the UK with high-quality components.

The 1978 is a Buss Compressor like no other - compression with character, controlled distortion, tonal shaping, wet/dry mixing - others have tried but have never managed to build a compressor that is this versatile and yet intuitive. It's never been easier to get that elusive characteristic sound that sets you apart from the rest. Glue your mix, bring out the bass, control the highs, add warmth, distortion, smoothen, widen, sound less digital more analogue - and at a price that's right for even the smallest studio.

The key features are as follows:

- Fast Reacting Stereo FET Design compressor with excellent Left/Right Tracking across the Full Range of compression and in a 1u rack mount housing.
- Threshold, Ratio, Attack and Release controls and Gain Reduction Metering provide familiar and initiativ control over the audio. Anyone that knows how to use a compressor can operate the 1978.
- 4 character switches provide a multitude of compression flavour combinations that allow the 1978 to take on the characteristics of other compressors.
- Comprehensive side chain EQ giving simultaneous control of frequency and level of filtering for the low and high bands. This works in conjunction with the rear panel stereo insert points that provide even further control.
- Variable Wet/Dry Mix plus Output Gain Knobs give a 'Parallel Compression' function without the need for external mixing devices, providing Complete and Effortless Control over the amount of compression used and Output Levels.
- Two Analogue V.U. Meters with Switchable +10dB Meter Rescale Mode. These have additional dual colour backlighting that act as a visual indication for the amount of saturation.
- Time delay relays on outputs for clean power up/down.
- Internal Low Hum Toroidal Linear Power Supply with Voltage Selector Switch.
- Classic Drawmer Build Quality with Rugged Steel Chassis and Aluminium Front Panel.
- Designed and manufactured by Drawmer in the UK.

INSTALLATION

The 1978 is designed for standard 19" rack mounting and occupies 1U of rack space. Avoid mounting the unit directly above power amplifiers or power supplies that radiate significant amounts of heat and always connect the mains

earth to the unit. Fibre or plastic washers may be used to prevent the front panel becoming marked by the mounting bolts. It is also advisable to leave space above the unit to allow the heat to dissipate.

AUDIO CONNECTIONS

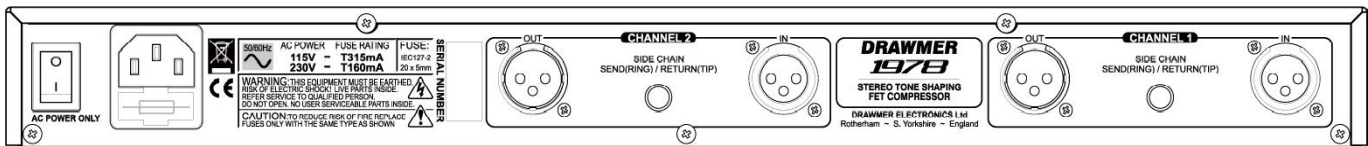

The inputs and outputs are electronically balanced on conventionally wired XLRs (pin 1 screen, pin 2 hot, pin 3 cold and XLR shell is connected to chassis). The operating level is nominally +4dBu. Balanced use is recommended.

• Interference:

If the unit is to be used where it maybe exposed to high levels of disturbance such as found close to a TV or radio transmitter, we advise that the unit is operated in a balanced configuration. The screens of the signal cables should be connected to the chassis connection on the XLR connector as opposed to connecting to pin1. The 1978 conforms to the EMC standards.

• Ground Loops:

If ground loop problems are encountered, never disconnect the mains earth, but instead, try disconnecting the signal screen on one end of each of the cables connecting the outputs of the 1978 to the patchbay. If such measures are necessary, balanced operation is recommended.

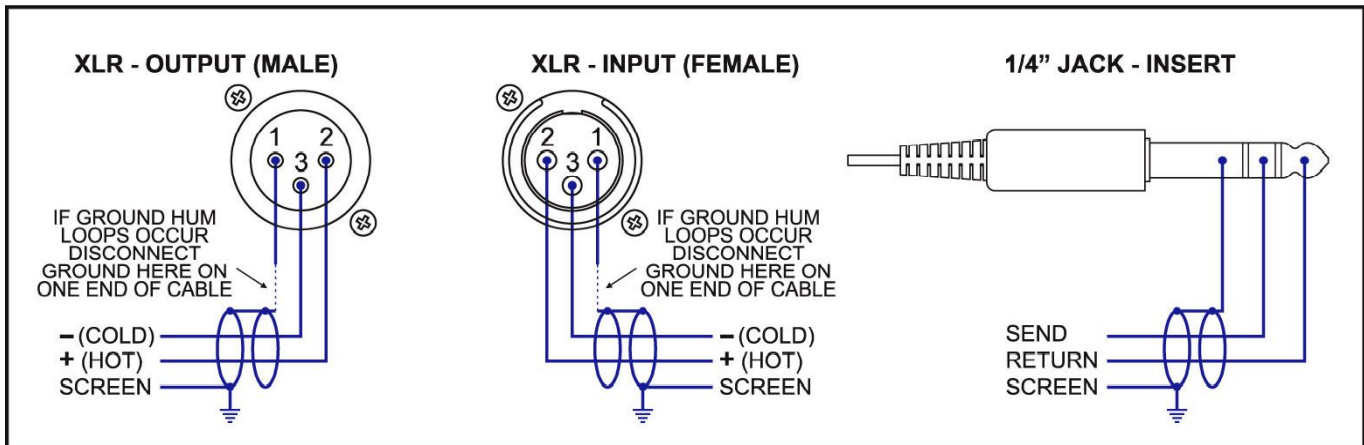

1978 CONNECTOR WIRING

SIDE CHAIN

The external side chain feature on the 1978 is part of the compressor feedback stage and would normally be connected to a normalised or semi-normalised pair of patchbay contacts. This would allow the user to insert EQ in addition to the Tonal shaping on the front panel for some de-essing, or frequency conscious compression. The side-chain access point is unbalanced, connection is via stereo 1/4" jacks, the wiring convention being: ring is signal send, tip is signal return and sleeve ground.

POWER CONNECTION

The 1978 unit will be supplied with a power cable suitable for domestic power outlets in your country. For your own safety, it is important that you use this cable to connect to the mains supply earth. The cable must not be tampered with or modified.

The power supply socket has an integral fuse drawer containing the power fuse of the same value, to suit the mains voltage for which the unit has been supplied. Removal of the drawer is only possible with the power cord removed. The fuse should never blow under normal operation. If the fuse is suspected of having blown, then a fault will have occurred and this fault condition should be inspected by a qualified service engineer. When replacing the fuse, always comply with the Safety Instructions.

If the unit is to be used with a mains input operating voltage different to that for which the unit is supplied, the following procedure must be carried out by a technically competent person, (see following diagrams)

1: Disconnect the unit from the mains.

2: Using a number 1 size pozidrive screwdriver, remove the seven self-tapping screws that retain the top cover. Two screws are found along each side; two along the top edge at the rear; and the upper central screw on the front fascia panel.

3: Slide the voltage change-over switch (**S11**) until the correct (or nearest) mains input voltage is visible on the switch actuator.
(see fig.2)



fig.2 The Voltage Selector Switch

For conversion to 115Volt AC (previously set to 230Volt AC).....

4a: Exchange the 160mA fuse below the mains socket for a similar type rated at 315mA

For conversion to 230Volt AC (previously set to 115Volt AC).....

4b: Exchange the 315mA fuse below the mains socket for a similar type rated at 160mA

In all cases:

5: Replace the top cover using the seven screws.

6: Re-connect to mains power source.

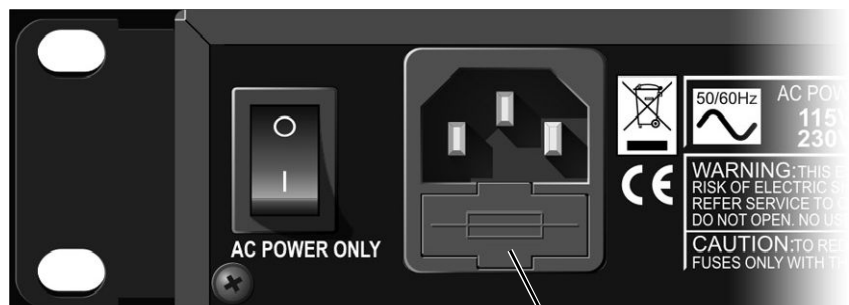
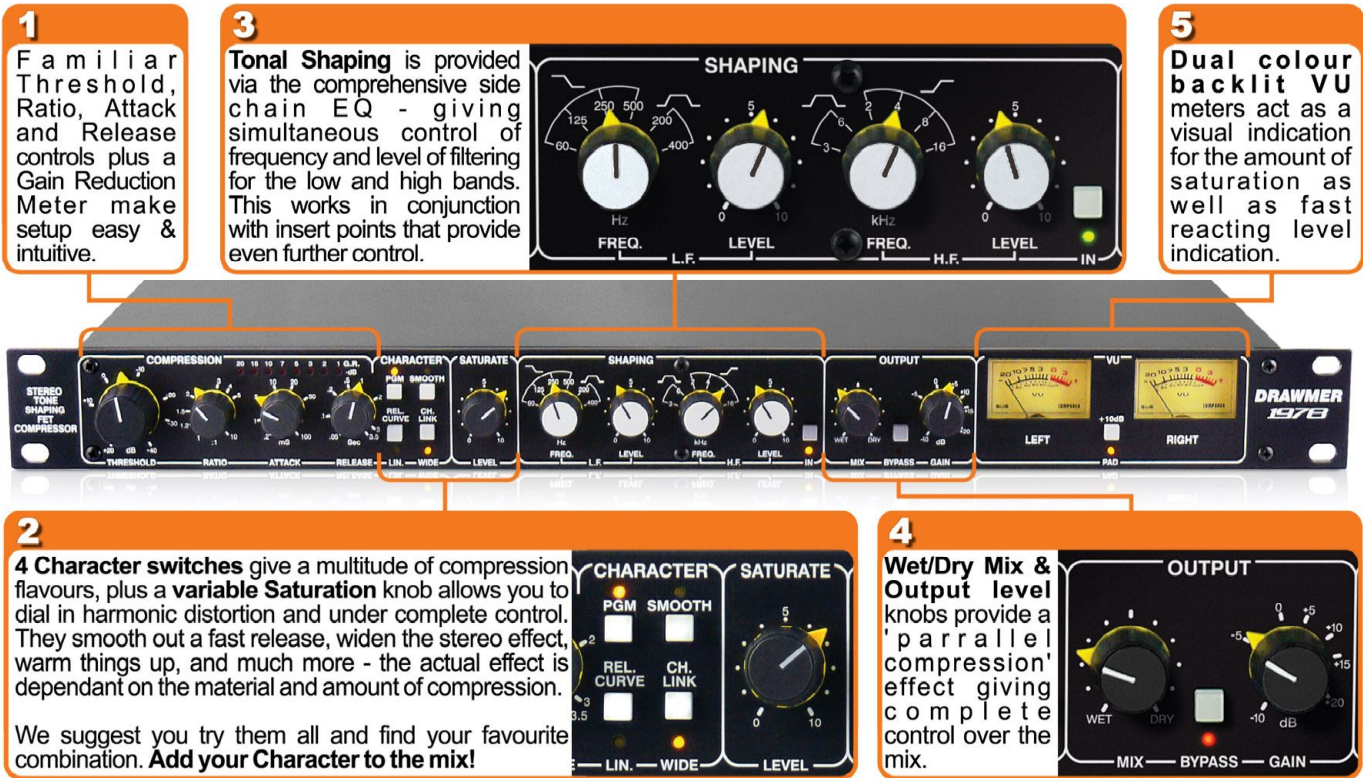

fig.3 The Location of the Fuse

CONTROL DESCRIPTION

The General Layout and Features



1 - COMPRESSOR

Threshold 40.0dB - +20dB

Determines the input level above which gain reduction will be applied. Soft knee compression takes place for signals exceeding the threshold level by a few decibels, above which level conventional 'ratio' compression is applied.

Ratio 1:1 to 10:1

Ratio determines the amount of compression (attenuation) to be used once the 'soft-knee' region is exceeded. If the ratio is set to 5:1 a signal exceeding the threshold by 5dB will be attenuated down to 1dB above the threshold, and likewise, a signal exceeding the threshold by 15dB will be attenuated down to 3dB above it. A ratio of 1:1 provides no compression, 4:1 is moderate, 8:1 strong, whilst 10:1 would be seen as approaching limiting.

Gain Reduction Meter 1 to 20dB

An eight segment LED bargraph meter continuously monitors the gain reduction applied by the compressor and gives an indication of the amount of gain required to bring the signal back to its input level after it has been compressed.

Attack 0.2mS to 100mS

Sets the rate at which the compressor will respond to input signal that exceed the threshold level.

Release 0.05S to 3.5S

Sets the rate at which the system gain returns to normal after the input signal level has fallen below the threshold.

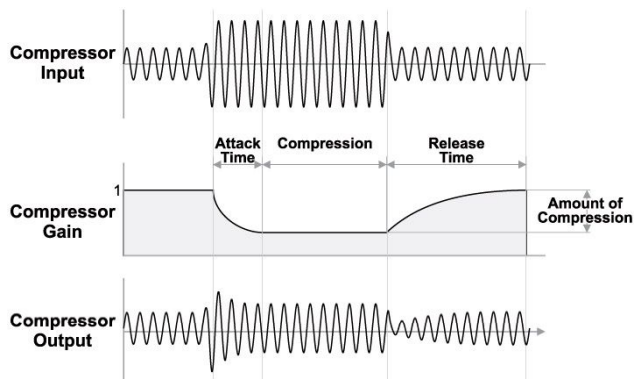
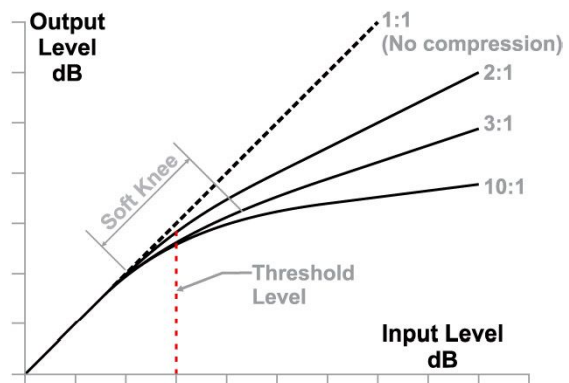

2 - COMPRESSION CHARACTER

Release Curve

Logarithmic / Linear

In its out position this is the classic log release as used on most compressors, when engaged this changes to a linear release which means the initial release isn't as fast but the total release time is the same for 10dB compression. This gives a less aggressive sound, especially at fast release times.

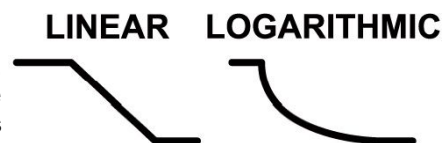

Channel Link

Normal / Wide

Normally, Left and Right channels respond equally under compression.

When engaged, WIDE channel linking changes to partial summing of left and right channels before the side chain, to produce a wider image under compression.

PGM

Off / PGM

This switch when engaged will introduce a second, slower release time in proportion to the density of program material above the threshold. The effect is to reduce excessive 'pumping' under heavy compression.

Smooth

Off / Smooth

When engaged this adds extra circuitry which slows the initial release, which might otherwise introduce distortion at low frequencies (i.e. bass guitar), when using fast release times.

3 - SATURATION

Level

0 to 10

Saturation adds a combination of second and third harmonics to the signal and can range from a subtle sweetening effect up to gritty distortion. It can be used in conjunction with the compressor or stand alone. The V,U, meter backlights start to become red as saturation becomes audible.

Unless excessive saturation is required for a particular effect, this control should be used with caution.

4 - SHAPING

On the 1978 the Shaping section is much more than the standard side chain E.Q. that most compressor's would incorporate, replacing any dulling of high frequency detail by simply adding gain, but a fully variable dynamic process that works in conjunction with the compressor, giving more 'bass' and 'brightness' as and when it's required. **In addition, the shaping on the 1978 can be used in conjunction with an external sidechain via the rear panel insert points to provide even more sidechain control.**

L.F.

The Low Frequency controls are fully variable allowing complete and subtle adjustments to the perceived level of bass, and the control of 'pumping' and ducking that occurs.

L.F. Frequency

Shelf - 60 / 125 / 250 / 500 Bell - 200 / 400 Hz

Sets the frequency that the L.F. Level control operates at, enabling the engineer to target a specific bass frequency.

L.F. Level

0 to 10

As the L.F. Level is increased the compressor's side chain sensitivity to low frequencies is reduced, with the result that less gain reduction is applied to those frequencies, creating the effect that the bass is louder. It also has the benefit of reducing the ducking and pumping effect that occurs by high frequencies being 'pulled down' in sync with the bass, helping to make mix compression much more affable.

H.F. Frequency

Bell - 3/6 Shelf - 2 / 4 / 8 / 16 kHz

Sets the frequency that the H.F. Level control operates at, enabling the engineer to target a specific high frequency.

H.F.

H.F. shaping is used to manipulate the high end of an audio signal so that it sounds more intimate, detailed and transparent, but without making it sound harsh or introducing any noticeably unnatural artefacts. Cymbals are more vibrant without becoming splashy, and vocals sound more open but without becoming sibilant. Being full range the 1978 will compress quiet high frequencies whenever the low frequencies are being brought under control, resulting in a dulling of these high levels, and in the worst cases, pumping - it is here where the V.H.F. controls are at their most effective.

H.F. Level 0 to 10

As the H.F. Level is increased the compressor's side chain sensitivity to high frequencies is reduced, with the result that less gain reduction is applied to those frequencies, creating the effect that the higher frequencies are enhanced. It can be used to add definition, particularly to the human voice and acoustic instruments.

In Off / On

Switches the tonal shaping in and out (i.e. bypassing the sidechain) to allow for A/B comparisons between settings. Note that Tonal Shaping and the rear panel sidechain Inserts work simultaneously and in conjunction with each other - this provides an incredible amount of control over the compressor sidechain. If you wish to use the external inserts only the shaping bypass switch should be out, so that the front panel shaping is not active but the inserts are. Should you wish to use the front panel shaping only either disconnect the jacks from the insert connectors or set the external unit into bypass.

TIP

Because the shaping controls have bell frequencies as well as shelf they cover the full range of frequencies available within the 1978, and thus, it is possible to control the mid frequencies using just the front panel shaping controls, without the need for an external insert. If you set the L.F. Frequency to 400Hz Bell and the H.F. Frequency to 3kHz Bell you are effectively controlling the mid range with a wide bandwidth in just the same way as you would control the L.F. and H.F. This could be used to adjust the overall balance of a mix, or on individual instruments, to bring out the raspiness in a voice, for example.

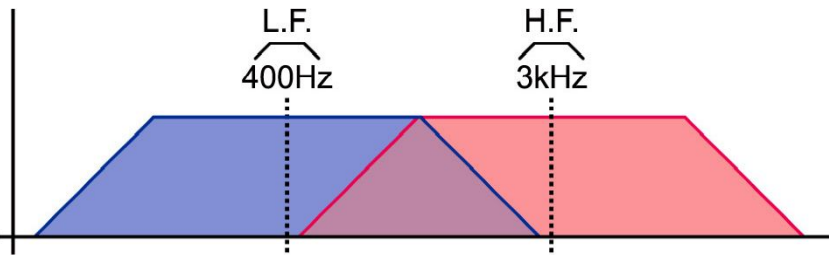

NOTE

As well as affecting the sidechain the shaping controls also add a small amount of E.Q. to the signal. This varies in conjunction with the L.F. and H.F. Level controls - as these are set higher the E.Q. level also rises to a maximum of +3dB when the level controls are in the 10 position. This feature can be disabled using internal jumpers. Please contact mail@drawmer.com for details.

5 - OUTPUT

Mix WET / DRY

A variable control that mixes a user defined amount of 'uncompressed' signal (dry) with the compressed signal (wet) to create a 'parallel compression effect' without the need for external mixing devices. In this way the amount of overall compression on the stereo signal is under complete control - set the 1978 to provide heavy compression but then reduce the overall effect by mixing in some of the dry signal using the mix control.

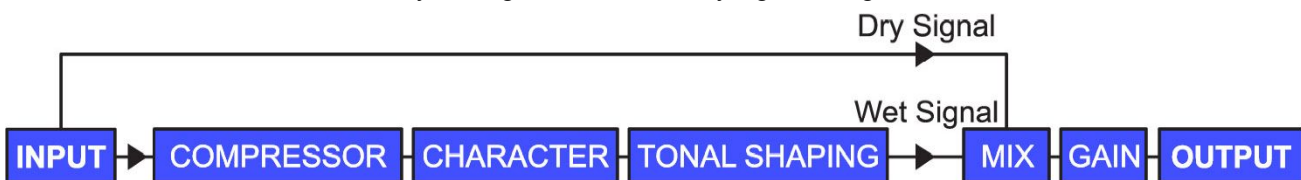

Bypass Off / On

A fully balanced hard-wire unit bypass connects the input directly to the output without alteration. Note: To see the input level on the VU meters the Bypass switch should be on, as the meters display the level found at the output.

Gain -20 to +10dB

During compression the signal is attenuated, gain may be required to produce the required output level. Adjust so that the output signal approaches the desired level only on signal peaks. The amount of gain required in order to bring the signal level to the same as at input is displayed on the G.R. meter.

6 - VU METERS

Left / Right VU Meters

Two moving coil VU meters monitor the level of the output signal. Because the meter has VU characteristics, it closely reflects what is actually being heard, though will not respond quickly enough to register short signal peaks. Note that the meters are back lit yellow to aid reading in low light environments, however, as the Saturation is increased the back light turns red to indicate the 'warmth' that the 1978 is creating.

+10dB Pad 0dB / +10dB

A two position switch adjusts the meters to show either normal output level, and for those working at 'hot' output levels VU +10dB modes. i.e. with the switch at VU +10dB - when the VU meter reads 0dB the actual level is +10dB.

GENERAL INFORMATION

It is the responsibility of the installer to ensure that the continuous power rating of the speakers is not exceeded, as Drawmer Electronics Ltd will not accept any responsibility for speaker damage caused by incorrect settings.

IF A FAULT DEVELOPS

For warranty service please call Drawmer Electronics Ltd. or their nearest authorised service facility, giving full details of the difficulty.

A list of all main dealers can be found on the Drawmer webpages.

On receipt of this information, service or shipping instructions will be forwarded to you.

No equipment should be returned under the warranty without prior consent from Drawmer or their authorised representative.

For service claims under the warranty agreement a service Returns Authorisation (RA) number will be issued.

Write this RA number in large letters in a prominent position on the shipping box. Enclose your name, address, telephone number, copy of the original sales invoice and a detailed description of the problem.

Authorised returns should be prepaid and must be insured.

All Drawmer products are packaged in specially designed containers for protection. If the unit is to be returned, the original container must be used. If this container is not available, then the equipment should be packaged in substantial shock-proof material, capable of withstanding the handling for the transit.

CONTACTING DRAWMER

Drawmer Electronics Ltd., will be pleased to answer all application questions to enhance your usage of this equipment. Please address correspondence to:

Drawmer (Technical Help line)
Coleman Street
Parkgate
Rotherham
S62 6EL
UK

Alternatively contact us by E-mail on :

tech@drawmer.com

Further information on all Drawmer dealers, Authorised service departments and other contact information can be obtained from our web pages on:

<http://www.drawmer.com>

1978 STEREO TONE SHAPING FET COMPRESSOR DATA SPECIFICATION

INPUT

Input Impedance 20k Ohms or greater
Maximum Input Level +21dBu

OUTPUT

Output Impedance <100 Ohms
Maximum Output Level +21dBu into 10k Ohms Load

FREQUENCY RESPONSE

20Hz to 20kHz +/-0.2dB

CROSSTALK

< -70dB @ 1kHz

NOISE AT UNITY GAIN

with flat EQ response switched in circuit
22Hz - 22kHz -88dB

% DISTORTION (THD & NOISE) @ 1kHz

0dB (ref +4) 0.02%
10dB (ref +4) 0.2%

POWER REQUIREMENTS

230Volt or 115V at 50-60hZ, 15VA

FUSE RATING

T160mA for 230Volt,
T315mA for 115Volt
Conforming to IEC 127-2

FUSE TYPE

20mm x 5mm, Class 3 Timed-Blo, 250Volt working

CASE SIZE

482mm (W) x 44mm (H) x 202mm (D)

WEIGHT

2.7Kgs

BLOCK DIAGRAM

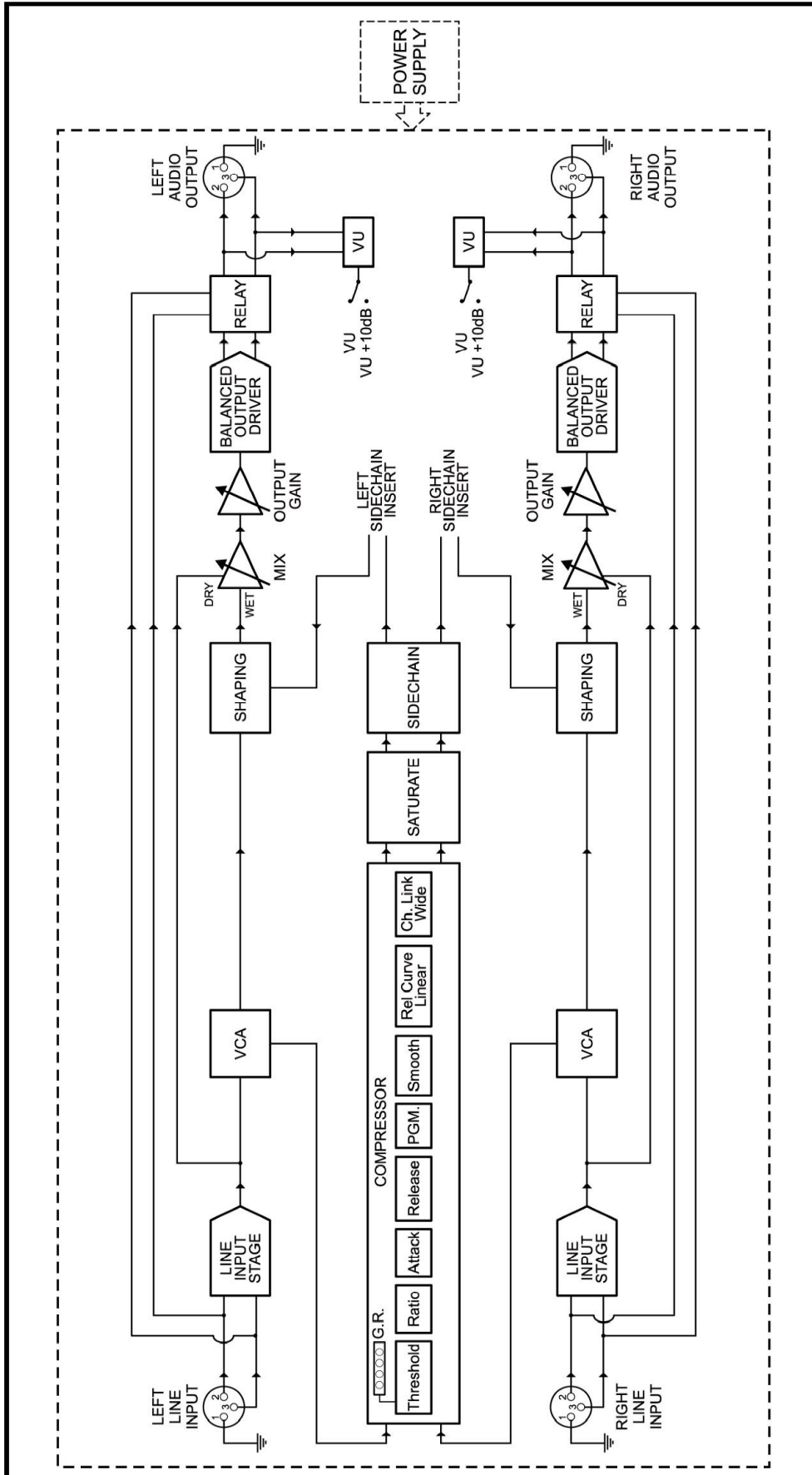

STEREO TONE SHAPING FET COMPRESSOR

COMPRESSION THRESHOLD: +20 dB, 0, -10; RATIO: 1:1, 1.2, 1.5, 2, 3, 4; GAIN REDUCTION: -30, -20; RELEASE: .05, .1, .2, .5, 1, 2, 3, 5, 10, 20, 50, 100, 200, 500, 1000, 2000, 5000, 10000 Hz; CHARACTER: PGM SMOOTH, REL. CURVE, CH. LINK, WIDE; ATTACK: .2, .5, 1, 2, 3, 5, 10, 20, 50, 100, 200, 500, 1000, 2000, 5000, 10000 ms; RELEASE: .05, .1, .2, .5, 1, 2, 3, 5, 10, 20, 50, 100, 200, 500, 1000, 2000, 5000, 10000 Sec; SATURATE: LEVEL 0, 5, 10; SHAPING: L.F. FREQ. 60, 125, 250, 500 Hz; H.F. FREQ. 2, 3, 4, 6, 8, 10 kHz; LEVEL 0, 5, 10; IN

DRAWMER 1978

OUTPUT MIX: WET, DRY; BYPASS; GAIN: -5, 0, +5, +10, +15, +20 dB; **LEFT** VU: -20, -10, 0, 10, 20; **RIGHT** VU: -20, -10, 0, 10, 20; PAD: +10dB; IN

DRAWMER 1978
Session Recall
 DRAWMER ELECTRONICS LTD ~ Coleman Street
 Rotherham ~ S. Yorkshire ~ UK
 © COPYRIGHT DRAWMER ELECTRONICS LTD 2015

Session No.	
Date	
Artist	
Tape Location	