

**th•mann**

DP-33  
digital piano



Musikhaus Thomann  
Thomann GmbH  
Hans-Thomann-Straße 1  
96138 Burgebrach  
Germany  
Telephone: +49 (0) 9546 9223-0  
E-mail: [info@thomann.de](mailto:info@thomann.de)  
Internet: [www.thomann.de](http://www.thomann.de)

24.11.2020, ID: 326890

## Table of contents

<b>1</b>	<b>General notes</b> .....	<b>5</b>
	1.1 Further information.....	5
	1.2 Notational conventions.....	5
	1.3 Symbols and signal words.....	6
<b>2</b>	<b>Safety instructions</b> .....	<b>7</b>
<b>3</b>	<b>Features</b> .....	<b>9</b>
<b>4</b>	<b>Assembly instructions</b> .....	<b>10</b>
<b>5</b>	<b>Control panel and connections</b> .....	<b>14</b>
<b>6</b>	<b>Connectivity options</b> .....	<b>17</b>
<b>7</b>	<b>Switching on / off and basic operation</b> .....	<b>19</b>
	7.1 Switching the digital piano on.....	19
	7.1.1 Normal switching on / off.....	19
	7.1.2 Automatic shutoff.....	19
	7.2 Adjusting the volume.....	19
	7.3 Demo song.....	20
<b>8</b>	<b>Functions</b> .....	<b>21</b>
	8.1 Rehearsal songs.....	21
	8.1.1 Selecting, playing and stopping rehearsal songs.....	21
	8.2 Voices and effects.....	22
	8.2.1 Selecting voices .....	22
	8.2.2 Dual mode.....	22
	8.2.3 Split mode.....	23
	8.2.4 Demo mode.....	23
	8.2.5 Touch sensitivity.....	24
	8.2.6 Digital effects.....	25
	8.2.7 Metronome.....	26
	8.2.8 Tempo.....	26
	8.2.9 Transposing.....	27
	8.2.10 Fine tuning.....	27
	8.2.11 Key Tone.....	28
	8.3 MIDI functions.....	28
	8.3.1 What is MIDI?.....	28
	8.3.2 USB connection.....	28
	8.3.3 MIDI connection.....	29
	8.3.4 MIDI applications .....	29
	8.4 Troubleshooting.....	30
<b>9</b>	<b>Rehearsal and demo songs</b> .....	<b>31</b>
<b>10</b>	<b>MIDI implementation chart</b> .....	<b>33</b>
<b>11</b>	<b>Technical specifications</b> .....	<b>35</b>
<b>12</b>	<b>Plug and connection assignment</b> .....	<b>36</b>

**13 Protecting the environment..... 37**

# 1 General notes

This user manual contains important information on the safe operation of the device. Read and follow all safety notes and all instructions. Save this manual for future reference. Make sure that it is available to all persons using this device. If you sell the device to another user, be sure that they also receive this manual.

Our products and user manuals are subject to a process of continuous development. We therefore reserve the right to make changes without notice. Please refer to the latest version of the user manual which is ready for download under [www.thomann.de](http://www.thomann.de).

## 1.1 Further information

On our website ([www.thomann.de](http://www.thomann.de)) you will find lots of further information and details on the following points:

Download	This manual is also available as PDF file for you to download.
Keyword search	Use the search function in the electronic version to find the topics of interest for you quickly.
Online guides	Our online guides provide detailed information on technical basics and terms.
Personal consultation	For personal consultation please contact our technical hotline.
Service	If you have any problems with the device the customer service will gladly assist you.

## 1.2 Notational conventions

This manual uses the following notational conventions:

### Letterings

The letterings for connectors and controls are marked by square brackets and italics.

**Examples:** *[VOLUME]* control, *[Mono]* button.

### Displays

Texts and values displayed on the device are marked by quotation marks and italics.

**Examples:** '24ch', 'OFF'.

## Instructions

The individual steps of an instruction are numbered consecutively. The result of a step is indented and highlighted by an arrow.

### Example:

1. ➤ Switch on the device.
2. ➤ Press [Auto].  
⇒ Automatic operation is started.
3. ➤ Switch off the device.



## Cross-references

References to other locations in this manual are identified by an arrow and the specified page number. In the electronic version of the manual, you can click the cross-reference to jump to the specified location.

Example: See ➤ 'Cross-references' on page 6.

## 1.3 Symbols and signal words

In this section you will find an overview of the meaning of symbols and signal words that are used in this manual.

Signal word	Meaning
<b>DANGER!</b>	This combination of symbol and signal word indicates an immediate dangerous situation that will result in death or serious injury if it is not avoided.
<b>CAUTION!</b>	This combination of symbol and signal word indicates a possible dangerous situation that can result in minor injury if it is not avoided.
<b>NOTICE!</b>	This combination of symbol and signal word indicates a possible dangerous situation that can result in material and environmental damage if it is not avoided.
Warning signs	Type of danger
	Warning – high-voltage.
	Warning – danger zone.

## 2 Safety instructions

### Intended use

This device is intended to be used for electronic sound generation using a piano keyboard. Use the device only as described in this user manual. Any other use or use under other operating conditions is considered to be improper and may result in personal injury or property damage. No liability will be assumed for damages resulting from improper use.

This device may be used only by persons with sufficient physical, sensorial, and intellectual abilities and having corresponding knowledge and experience. Other persons may use this device only if they are supervised or instructed by a person who is responsible for their safety.

### Safety

**DANGER!****Danger for children**

Ensure that plastic bags, packaging, etc. are disposed of properly and are not within reach of babies and young children. Choking hazard!

Ensure that children do not detach any small parts (e.g. knobs or the like) from the unit. They could swallow the pieces and choke!

Never let children unattended use electrical devices.

**DANGER!****Electric shock caused by short-circuit**

Always use proper ready-made insulated two-wire mains cabling (power cord). Do not modify the mains cable or the plug. Failure to do so could result in electric shock/death or fire. If in doubt, seek advice from a registered electrician.

**DANGER!****Electric shock caused by high voltages inside**

Within the device there are areas where high voltages may be present. Never remove any covers.

There are no user-serviceable parts inside.

Do not use the device if covers, protectors or optical components are missing or damaged.

**CAUTION!****Possible hearing damage**

With loudspeakers or headphones connected, the device can produce volume levels that may cause temporary or permanent hearing impairment.

Do not operate the device permanently at a high volume level. Decrease the volume level immediately if you experience ringing in your ears or hearing impairment.

**CAUTION!****Risk of injury due to heavy weight**

Due to the heavy weight of the device, at least two persons are required for transport and installation.

**NOTICE!****Operating conditions**

This device has been designed for indoor use only. To prevent damage, never expose the device to any liquid or moisture. Avoid direct sunlight, heavy dirt, and strong vibrations.

**NOTICE!****Power supply**

Before connecting the device, ensure that the input voltage (AC outlet) matches the voltage rating of the device and that the AC outlet is protected by a residual current circuit breaker. Failure to do so could result in damage to the device and possibly injure the user.

Unplug the device before electrical storms occur and when it is unused for long periods of time to reduce the risk of electric shock or fire.



### 3 Features

The digital piano is characterized by the following features:

- Keyboard: 88 weighted keys with hammer action and adjustable touch response.
- 26 sounds
- 64-voice polyphony
- Reverb
- Chorus
- Split mode
- Metronome
- Transpose function
- Equalizer (3 different timbres)
- Music Library with 60 rehearsal songs
- Speaker: 2 × 15 W
- 3 pedals
- Connections: 2 × headphones out, stereo AUX IN/OUT, USB MIDI 2.0
- Weight: 37 kg
- Dimensions (W × D × H): 1365 × 330 × 790 mm
- Finish: matt black
- Automatic switchoff

## 4 Assembly instructions

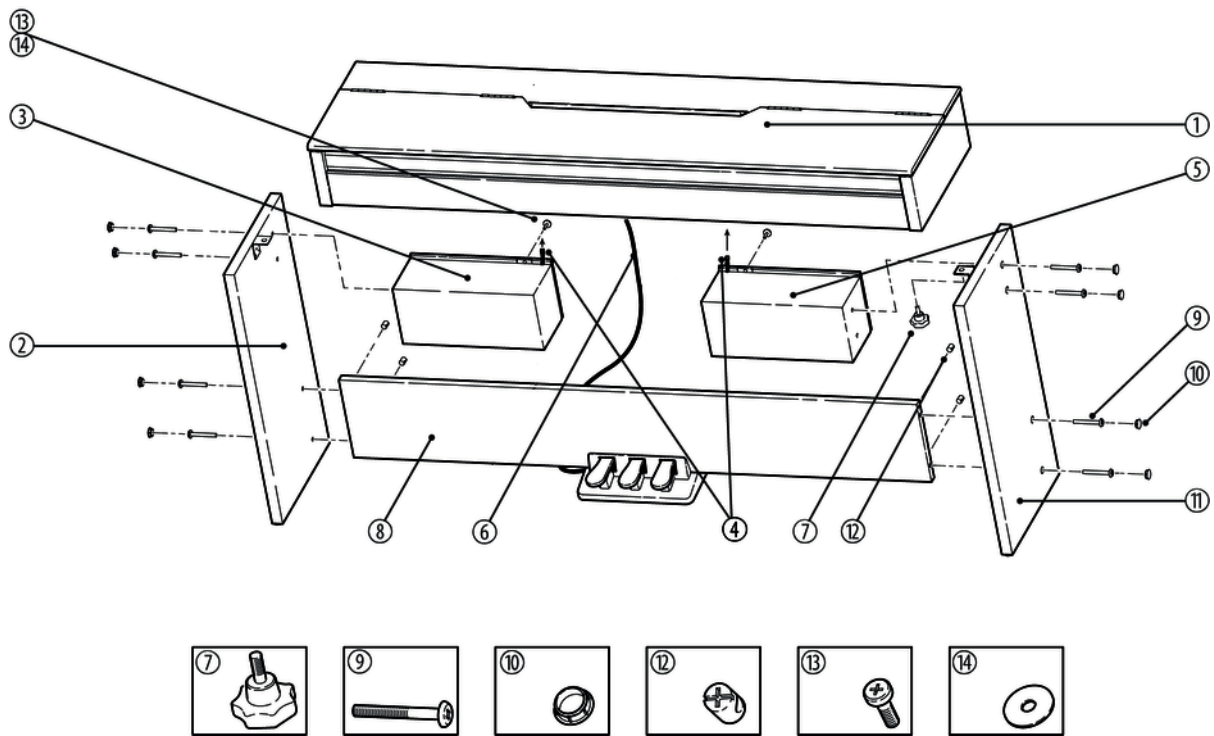

You need a Phillips screwdriver (not supplied) for the assembly of the digital piano. Open the package and please make sure before assembling that the entire scope of delivery is present, as posted here.

1. Digital piano housing	8. Pedal box with rear panel
2. Left side panel	9. Phillips-head screws 6 × 50 (8 pcs.)
3. Left speaker box	10. Screw caps (8 pcs.)
4. Speaker cable	11. Right side panel
5. Right speaker box	12. Phillips-head barrel nuts (4 pcs.)
6. Pedal cable	13. Phillips-head screws 4 × 15 (2 pcs.)
7. Hand screws (2 pcs.)	14. Seals (2 pcs.)

**Mechanical assembly**

Proceed according to the illustrations and exclusively use the supplied screws. Using other screws could damage the digital piano housing or the speaker boxes or result in a reduced stability of the digital piano.

- (7) Hand screws (2 pcs.)
- (9) Phillips-head screws 6 × 50 (8 pcs.) and
- (11) Phillips-head screws 4 × 15 (2 pcs.)

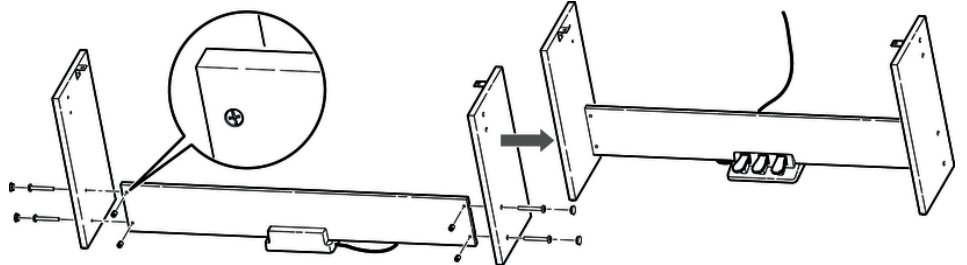

Insert the four Phillips-head barrel nuts (12) into the rear panel of the pedal box as shown in the left part of the figure. Use two screws 6 × 50 on each side to attach the two side panels to the pedal box and cover the four screws with screw caps.

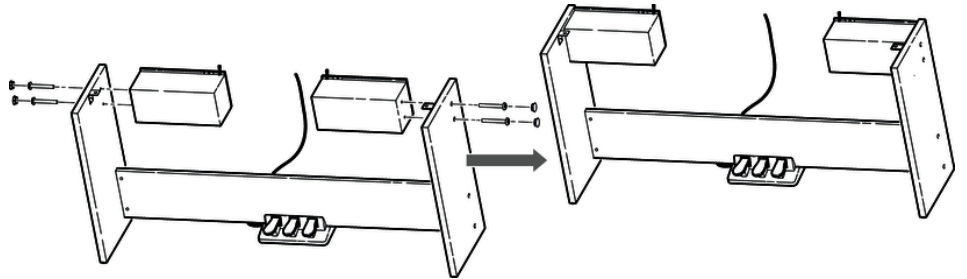

Attach the speakers with each two screws 6 × 50 to the side panels and cover the screws with screw caps.

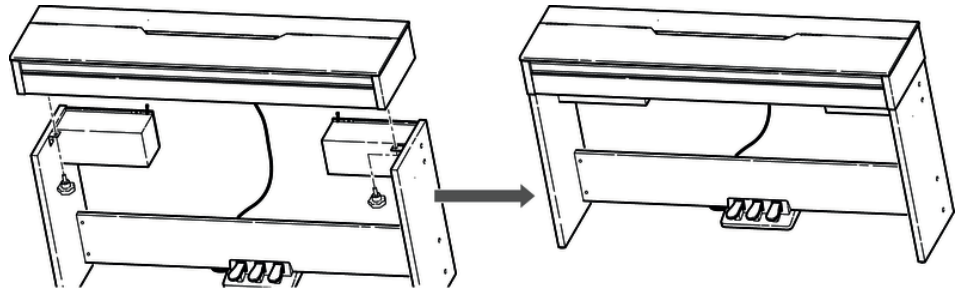

Put the digital piano housing on the stand and affix it using the two hand screws.

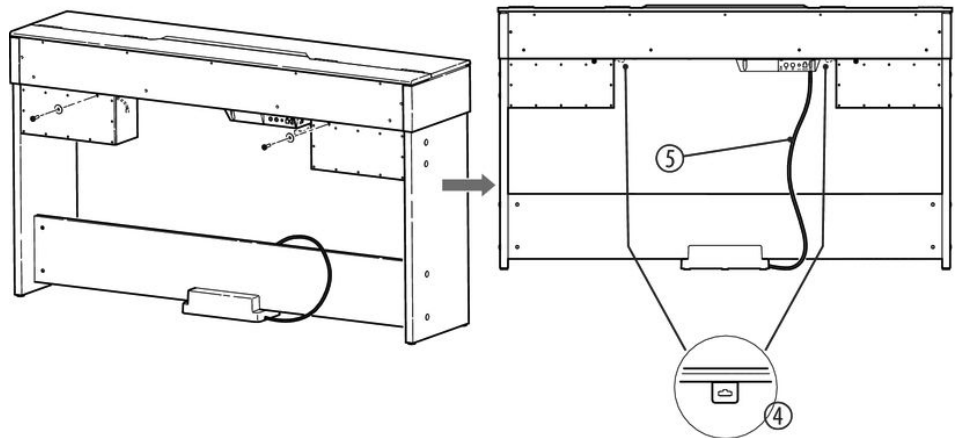

First fix the two speaker boxes with one screw each 4 × 15 and the associated seal on the digital piano housing.

Then connect the speaker cable on the right and left sides with the two connecting sockets at the bottom of the digital piano housing (4).



*Note that before connecting the speaker cable, the two speaker boxes must be installed on the digital piano housing. The speaker cables protrude a few centimetres based on the construction from the respective speaker housing!*

Connect the pedal cable (5) with the [PEDAL] connecting socket on the terminal box at the rear of the digital piano housing.

Move the digital piano to its designated location.

**Connecting the power supply**

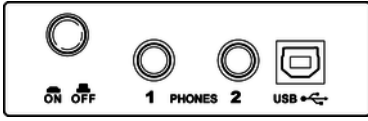

Make sure that the device is turned off before you connect it to the power supply or disconnect it.

**VOLUME**

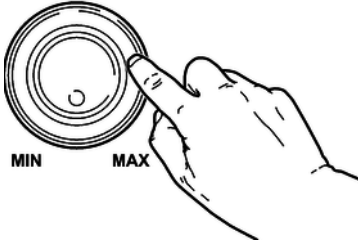

Turn the volume knob counter-clockwise to minimum before connecting the digital piano to the power supply or to other devices. This is to protect the speakers from damage.

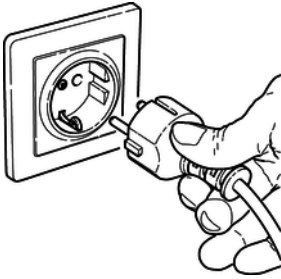

Connect the cable from the power adapter outlet to the input socket [DC IN] on the rear panel of the digital piano.

Plug the AC power cord into a properly wired mains wall outlet.

## 5 Control panel and connections

### Control panel left and right

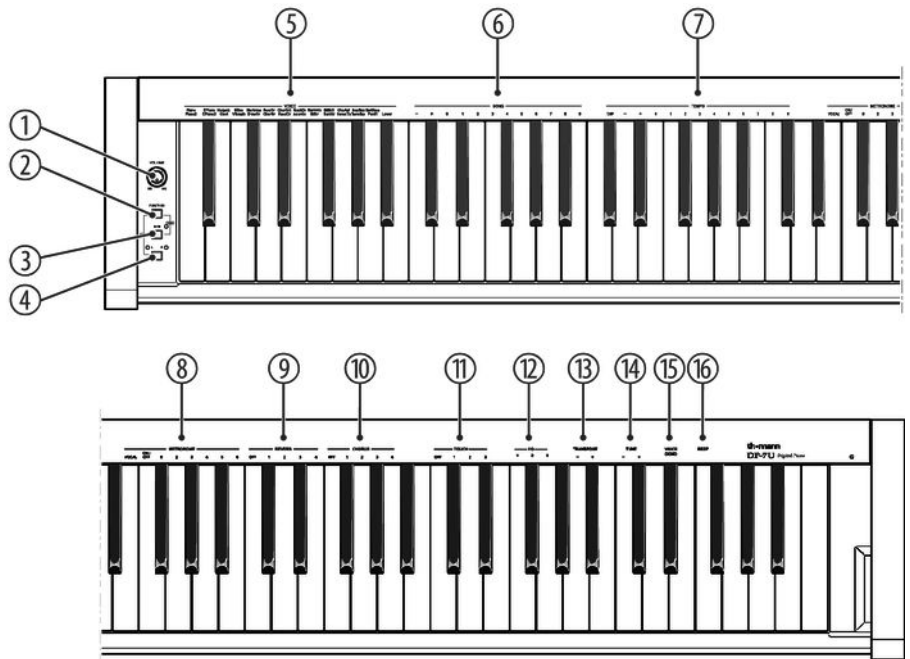

- |   |  |
|---|--|
| 1 | Rotary control <i>[VOLUME]</i> to set the volume.  |
| 2 | <i>[FUNCTION]</i> button. Press and hold this key while you call up a specific function with a piano key.  |
| 3 | <i>[START/STOP]</i> button to playback rehearsal songs.  |
| 4 | <i>[DEMO L – R]</i> button. In <i>[SONG]</i> mode, you can use it to select the left or right hand.  |
| 5 | Piano keys <i>[VOICE]</i> for sound selection. Keep the <i>[FUNCTION]</i> button pressed and select the desired sound with one of the piano keys.  |
| 6 | Piano keys <i>[SONG]</i> to select rehearsal songs. Keep the <i>[FUNCTION]</i> button pressed and select the desired practise song with the piano keys.  |
| 7 | Piano keys <i>[TEMPO]</i> to adjust the tempo. Keep the <i>[FUNCTION]</i> button pressed and select the desired tempo with the piano keys.   |
| 8 | Piano keys <i>[METRONOME]</i> to adjust the metronome and the time signature. Keep the <i>[FUNCTION]</i> button pressed and press the piano key <i>[ON/OFF]</i> to turn the metronome on or off. Keep the <i>[FUNCTION]</i> button pressed and press one of the other piano keys to adjust the time signature. |
| 9 | Piano keys <i>[REVERB]</i> to adjust the Reverb effect and the effects depth. Keep the <i>[FUNCTION]</i> button pressed and press the piano key <i>[OFF]</i> to turn the Reverb effect off. Keep the <i>[FUNCTION]</i> button pressed and press one of the other piano keys to adjust the effects depth.       |

10	Piano keys <i>[CHORUS]</i> to adjust the Chorus effect and the effects depth. Keep the <i>[FUNCTION]</i> button pressed and press the piano key <i>[OFF]</i> to turn the Chorus effect off. Keep the <i>[FUNCTION]</i> button pressed and press one of the other piano keys to adjust the effects depth.
11	Piano keys <i>[TOUCH]</i> to adjust the touch sensitivity. Keep the <i>[FUNCTION]</i> button pressed and select the desired touch sensitivity with one of the piano keys.
12	Piano keys <i>[EQ]</i> to adjust the timbre. Keep the <i>[FUNCTION]</i> button pressed and select the desired timbre with one of the piano keys.
13	Piano keys <i>[TRANSPOSE]</i> to transpose the note values. Keep the <i>[FUNCTION]</i> button pressed and transpose the note value by up to 12 semitones up or downwards using the <i>[+]</i> or <i>[-]</i> buttons.
14	Piano keys <i>[TUNE]</i> to fine tune the entire keyboard. Keep the <i>[FUNCTION]</i> button pressed and tune up or downwards in 2-cent increments using the piano keys <i>[+]</i> or <i>[-]</i> .
15	Piano key <i>[VOICE DEMO]</i> . Keep the <i>[FUNCTION]</i> button pressed and press the piano key <i>[VOICE DEMO]</i> to play the demo song. (see <a href="#">Chapter 8.2.4 'Demo mode'</a> on page 23)
16	Piano key <i>[BEEP]</i> . Keep the <i>[FUNCTION]</i> button pressed and press the piano key <i>[BEEP]</i> to turn the beep sound on pressing the function button on or off.

**Pedals**

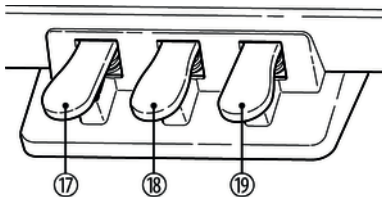

17	Soft-Pedal Using the Soft-Pedal softens the sound and reduces the overall volume.
18	Sostenuto-Pedal Depressing the Sostenuto-Pedal while striking a note or notes will hold those until the pedal is released.
19	Sustain-Pedal The Sustain-Pedal emulates the effect achieved lifting the string damper of an analog piano. All struck notes will sound longer.

**Rear panel connections**

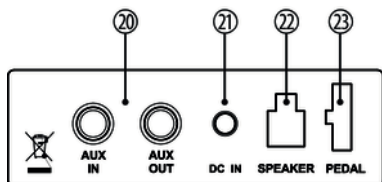

20	<i>[AUX IN]</i> Input for external audio devices like MP3 or CD players, playback via internal speakers. <i>[AUX OUT]</i> Output for external audio devices like active speakers or amplifiers.
21	<i>[DC IN]</i> Connection for the power adapter

22	[SPEAKER] Connection for speaker cable
23	[PEDAL] Connection for pedal cable

### Connection of the speaker cables

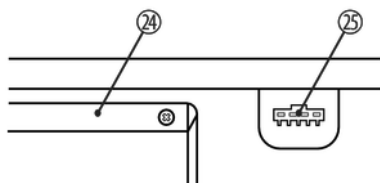

The two connector plugs for the cables of the speaker boxes are located at the notches on the left and right sides at the bottom of the digital piano housing.

24	Connecting box
25	Connector plug for the speaker boxes

### Piano keys

The keyboard keys are referred to in this manual as shown below.





## 6 Connectivity options

### Headphones

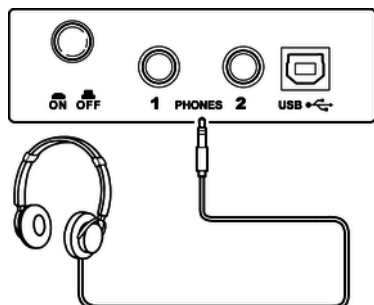

To the left beneath the keyboard you find the headphones outlets 1 and 2.

Connecting headphones (not supplied) to outlet 2 mutes the speakers.

Using outlet 2 maintains the sound output through the speakers.

### External audio devices via the AUX OUT socket

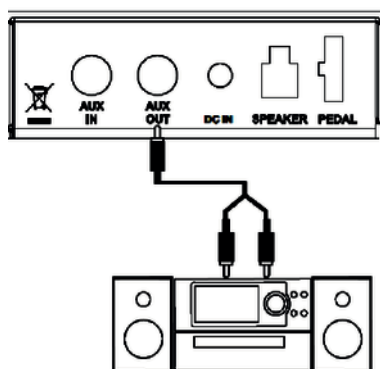

Use the AUX OUT socket to connect the digital piano to an amplifier, stereo device, mixing console or recording device. Plug one end of the audio cable into the AUX OUT socket on the rear panel of the digital piano and the other end into the input of the respective audio device.



#### NOTICE!

To prevent damage to the speakers, turn the volume down to 'Minimum' before you connect other devices to the digital piano.

### External audio devices via the AUX IN socket

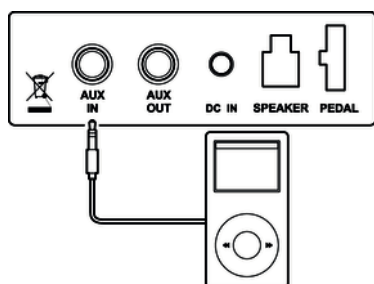

Use the AUX IN socket to connect a, for example, CD or MP3 player to the digital piano. So you can playback music through the internal speakers of the digital piano and simultaneously play along to it. Plug one end of the audio cable into the AUX IN socket on the rear panel of the digital piano and the other end into the output of the respective audio device.

### Computer

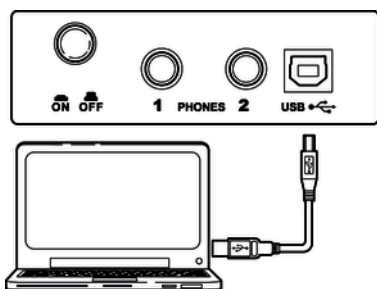

- USB/MIDI interface  
MIDI data is sent and received through the USB/MIDI interface.
- MIDI connections  
MIDI stands for 'Musical Instrument Digital Interface' and represents a global standard for the communication of numerous electronic instruments and sound modules.
  - MIDI IN: The device receives MIDI data from other devices through this port.
  - MIDI OUT: MIDI data generated by the digital piano is sent to other MIDI devices through this port.

## 7 Switching on / off and basic operation

### 7.1 Switching the digital piano on

#### 7.1.1 Normal switching on / off

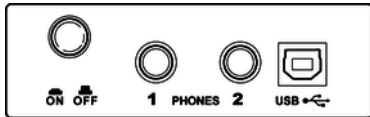

To turn the digital piano on or off, use the *[On / Off]* button located besides the headphones outlet on the bottom side (left) of the keyboard.

#### 7.1.2 Automatic shutoff

If the digital piano is not in use, it shuts off after 30 minutes automatically. To turn it back on, press the On/Off button.

By default, the automatic shutoff function gets initialized when you turn on the unit. To disable the function, keep the first left white key on the keyboard pressed while turning the unit on.

### 7.2 Adjusting the volume

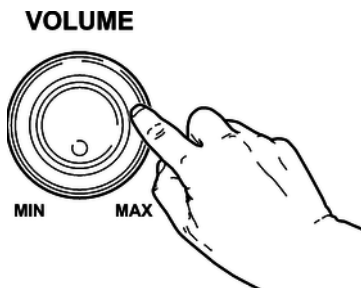

Adjust the rotary control *[VOLUME]* for a pleasant volume for playback and rehearsal. Turn this control clockwise to increase the volume. Turn it counter-clockwise to reduce the volume.

### 7.3 Demo song

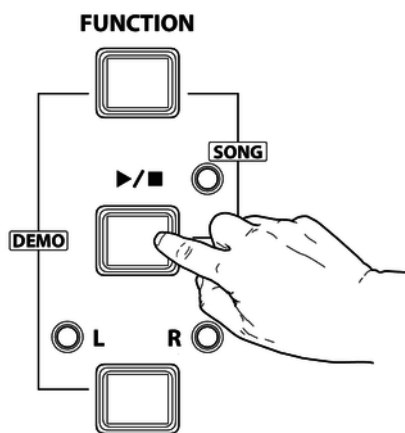

The built-in demo song shows the sound and the pitch range of the instrument.

1. ▶ Press the button *[START/STOP]* to start the playback of the demo song. At the same time, all the LEDs flash on the control panel. The demo song is playing in an endless loop. Press *[DEMO L – R]* to select separately the left or the right hand.
2. ▶ Press the button *[START/STOP]* again to stop playback and exit the current mode.

## 8 Functions

### 8.1 Rehearsal songs

#### 8.1.1 Selecting, playing and stopping rehearsal songs

The digital piano offers 60 rehearsal songs for practising in total (see [Chapter 9 'Rehearsal and demo songs'](#) on page 31).

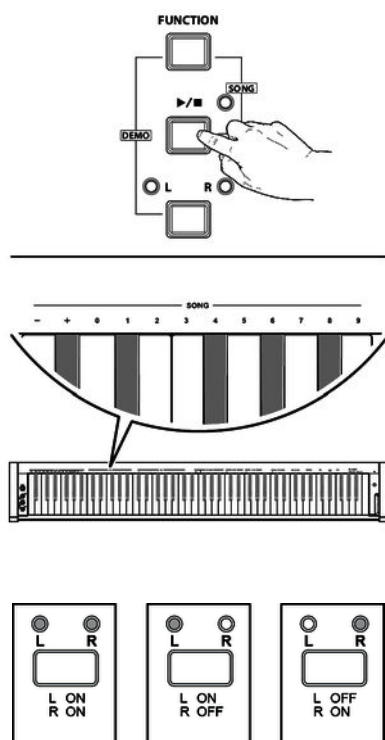

1. ➤ Keep the button *[FUNCTION]* pressed and press the *[START/STOP]* button, to enter the playback mode for rehearsal songs. All rehearsal songs are played in an endless loop.
2. ➤ Press the *[START/STOP]* button, to stop the currently playing rehearsal song. This will not quit the mode for rehearsal song playback *[SONG]*. If you press the *[START/STOP]* button again, this song is repeated in an endless loop until you press the *[START/STOP]* button again.

#### 3. ➤ Selecting rehearsal songs

Keep the *[FUNCTION]* button pressed and press the respective piano key in the *[SONG]* area to select the desired rehearsal song.



- Press the piano keys *[+]* and *[-]* simultaneously to select the first rehearsal song.
- To select the rehearsal song with the numeric keys, always enter the number in two-digit format. If you want to select the eighth rehearsal song, for example, press the piano keys *[0] [8]*.

#### 4. ➤ Practising left and / or right hand.

In *[SONG]* mode, you can repeatedly press the *[L – R]* buttons, to select either both tracks of the rehearsal songs for playback, or only the left or right track, so that you can practise your hands individually or both together. The setting is indicated by the LEDs.

## 8.2 Voices and effects

### 8.2.1 Selecting voices

You can call up to 26 voices via the piano keys in the [VOICE] area. Each piano key in the [VOICE] area is assigned to two voices. With the first keystroke you activate the voice that is given in the first row above the button, with the second keystroke you activate the voice that is specified in the second line above the key.

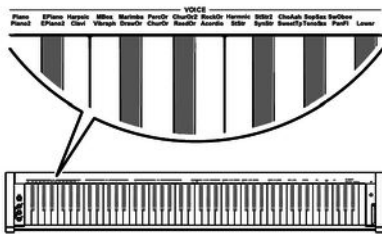
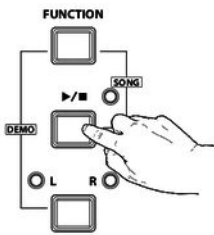

1. ➔ Keep the [FUNCTION] button pressed and press the desired piano key in the [VOICE] area.
2. ➔ To select a different voice, keep the [FUNCTION] button pressed and press the desired piano key in the [VOICE] area. Depending on whether the previously selected voice is shown in the first or second line above the piano key, when changing the voice that voice is selected that is specified in the corresponding line above the piano key.



*When selecting a voice, Dual and Split mode will automatically be disabled.*

### 8.2.2 Dual mode

In Dual mode, you can play two voices simultaneously.

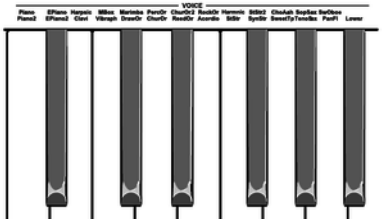
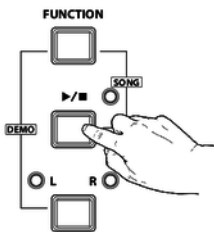

- ➔ Keep the [FUNCTION] button pressed and press the two desired piano keys in the [VOICE] area. Select the first voice with the first piano key and the second voice with the second piano key.



*If Dual mode is selected, the Split mode is automatically switched off.*



### 8.2.5 Touch sensitivity

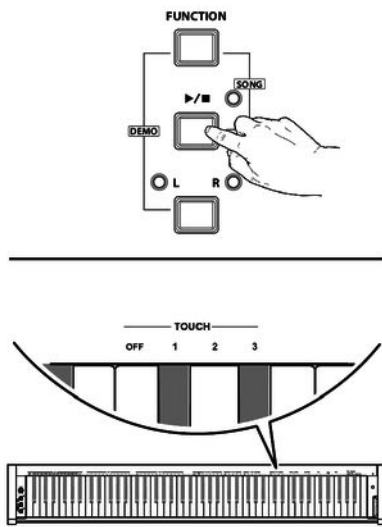

With this function you can adjust the touch response of the keyboard at four different levels.

Parameter	Description
[OFF]	Touch sensitivity is off. This can be very recommendable when playing the organ voice.
[1]	Soft In this setting, the volume is higher than usual even when playing with a soft touch.
[2]	Normal This setting corresponds to the usual touch response of a keyboard.
[3]	Hard In this setting, the volume is lower than usual even when playing with a hard touch.

➔ Keep the [FUNCTION] button pressed and press one of the piano keys in the [TOUCH] area to adjust the touch sensitivity.



## 8.2.6 Digital effects

### 8.2.6.1 Reverb and Chorus

With the reverb and chorus functions you can simulate acoustic effects under different environmental conditions.

→ Keep the *[FUNCTION]* button pressed and press one of the piano keys in the *[REVERB]* or *[CHORUS]* area to adjust the desired effect.

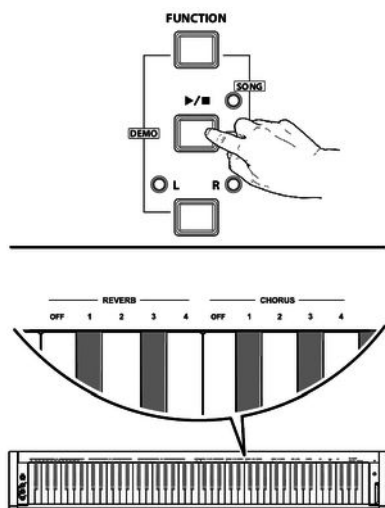

Piano key	in the <i>[REVERB]</i> area	in the <i>[CHORUS]</i> area
<i>[OFF]</i>	No Reverb	No Chorus
<i>[1]</i>	Chamber	Slight Chorus effect
<i>[2]</i>	Small hall	Medium Chorus effect
<i>[3]</i>	Large hall	Strong Chorus effect
<i>[4]</i>	Stadium	Flanger effect

### 8.2.6.2 Equalizer effect

The equalizer function allows three different settings.

→ Keep the *[FUNCTION]* button pressed and press one of the piano keys in the *[EQ]* area to adjust the desired effect.

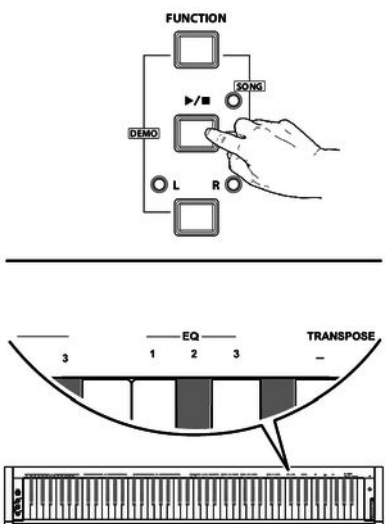

Piano key	Equalizer setting
<i>[1]</i>	Standard
<i>[2]</i>	Classic
<i>[3]</i>	Modern

## 8.2.7 Metronome

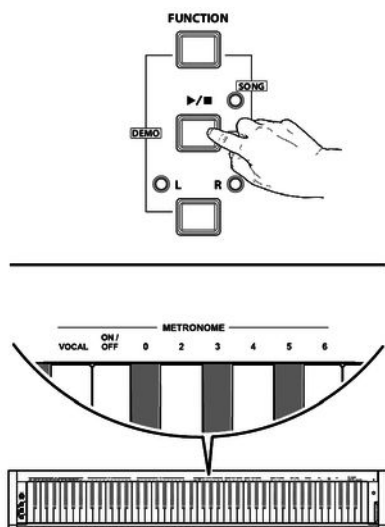

### 1. ▶ Turning the metronome on / off

Keep the [FUNCTION] button pressed and press the piano key [ON/OFF] in the [METRONOME] area to turn the metronome on or off.

### 2. ▶ Setting the time signature

Keep the [FUNCTION] button pressed and press one of the piano keys [0], [2], [3], [4], [5], [6] in the [METRONOME] area to set the desired time signature.

### 3. ▶ Setting the metronome sound

Keep the [FUNCTION] button pressed and press the piano key [VOCAL] in the [METRONOME] area to set a human voice or the click sound as the metronome sound.

## 8.2.8 Tempo

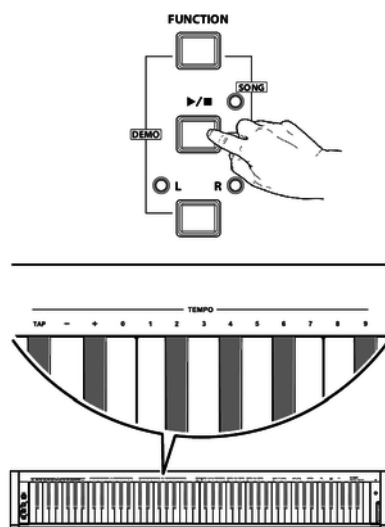

- ▶ Keep the [FUNCTION] button pressed and press the respective piano key in the [TEMPO] area to set the desired Tempo. You can set the Tempo by pressing the piano key [TAP] twice, or using the piano keys [+] and [-] or using the piano keys [0] to [9].



- If you press the buttons [+] and [-] in the [TEMPO] area simultaneously, the Tempo will be reset to the default standard value (120 beats per minute).
- The tempo can be adjusted in a range from 30 to 280 bpm.
- If you want to change the tempo with the piano keys [0] to [9], you always have to enter it in three-digit format. For example, to set tempo 85, you have to press the piano keys [0][8][5] in a row in the [TEMPO] area.

## 8.2.9 Transposing

With this function you can adjust the pitch of the keyboard in 12 semitone steps up or down.

→ Keep the [FUNCTION] button pressed and press the piano keys [+] and [-] in the [TRANSCOPE] area to adjust the keyboard pitch in semitone steps up or down.

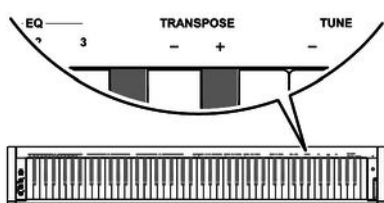
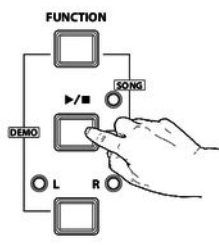

– Press the [+] and [-] buttons in the [TRANSCOPE] area simultaneously to restore the default setting (no transposition).

## 8.2.10 Fine tuning

With this function you can fine tune the entire keyboard in 0.2-Hz steps.

→ Keep the [FUNCTION] button pressed and press the piano keys [+] and [-] in the [TUNE] area to fine tune the keyboard. The value changes by 0.2 Hz in a range from -100 to +100 Hz per keystroke.

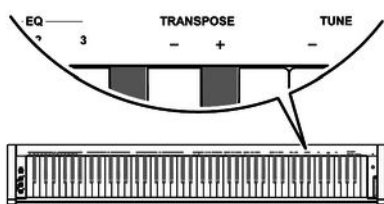
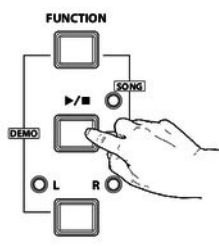

– Press the [+] and [-] buttons in the [TUNE] area simultaneously to restore the default setting (0 Hz).

### 8.2.11 Key Tone

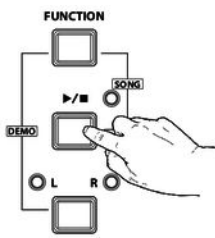

With this function, you can turn the Key Tone on or off. By default, the Key Tone is turned on. Keep the [FUNCTION] button pressed and press the piano key [BEEP] to turn the Key Tone on or off.

If you keep the [FUNCTION] button pressed and turn on the Key Tone, you will hear a beep tone every time you press a function button.

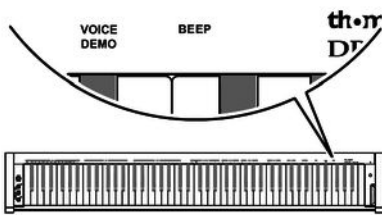

## 8.3 MIDI functions

### 8.3.1 What is MIDI?

1. ▶ MIDI stands for 'Musical Instrument Digital Interface' and represents the standard interface between a computer and electronic instruments.
2. ▶ You can use the USB connection to exchange MIDI data with computers or other USB devices that support USB audio via USB cable.
3. ▶ The digital piano can be connected to computers or other USB devices.
4. ▶ MIDI data from computers or other USB devices can be played back by the sound module of the piano.

### 8.3.2 USB connection

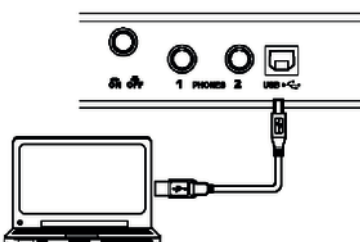

1. ▶ System requirements
  - CPU: 300 MHz, Pentium 2 or higher.
  - RAM: 64 MB min.
  - 2 MB free hard disc space.
  - Operating system: Windows® 2000/XP, Vista, Windows 7, Windows 8.
2. ▶ Connecting
 

Connect the USB port on the rear panel of the digital piano to the USB port on your computer using a standard USB cable (not included).

**3.** ▶ USB precautions

Please heed the following instructions when connecting USB instruments to computers. Otherwise, the instrument or the computer may 'crash', which can result in data loss. If a 'crash' should occur, turn off computer and instrument and restart them after a few seconds.



- If the computer is in standby or hibernation, wake the computer before connecting the USB cable.
- Establish the USB connection between computer and instrument before turning on the instrument.

**8.3.3 MIDI connection**

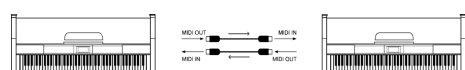
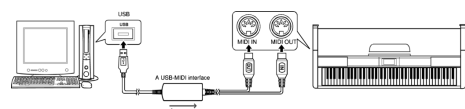

**1.** ▶ Tips on connecting

At MIDI connections, the device that controls other devices, is referred to as the 'Master'. A device that is controlled via MIDI is called 'Slave'. Connect the MIDI OUT of the master to the MIDI IN of the slave. You can not connect the MIDI OUT of a device to the MIDI IN of the same device.

**2.** ▶ Connection method

Connect the MIDI interface to the computer.

**3.** ▶ Additional devices

Connect additional devices via the MIDI interface.

**8.3.4 MIDI applications**

- The digital piano can control other equipment or electronic instruments.
- You can use other devices to control the digital piano.
- The digital piano can play MIDI files from a computer.

## 8.4 Troubleshooting

Problem	Possible causes and solutions
You hear a 'pop' sound from the speakers when switching the digital piano on and off.	This is normal. No need to worry.
No sound can be heard when playing the piano.	Make sure that the volume control is set appropriately. Check if headphones are plugged into the headphone output 2. Connecting headphones will mute the speakers of the digital piano.
Malfunction occurs when using a mobile phone.	Using a mobile phone near the digital piano can cause interference. To prevent this, turn off the mobile phone or use it only at a safe distance.

## 9 Rehearsal and demo songs

No.	Name	No.	Name
1	Waltz in A Flat Op.39, No.15	31	Mazurka
2	The Happy Farmer	32	Minuet 1
3	Etude	33	Minuet 2
4	Dance Of The Four Swans From 'Swan Lake'	34	Minuet 3
5	Carmen Suite No.2 Habanera	35	Minuet In G
6	A Little Polish Dance	36	Neapolitan Song
7	Jesus Saviour Pilot Me	37	Prelude
8	Old Macdonald Had A Farm	38	Salut D' Amour
9	O Sole Mio	39	Pizzicato Polka
10	Wedding March From 'Lohengrin'	40	Piano Sonata No.11 in A major KV 331, Andante grazioso
11	2-Part Invention No.13 In A Minor BWV 784	41	Songs Without Words Op.30 No. 6 F sharp minor Venetian Gondola Song
12	Turkish March	42	Duke Aria From 'The Rigoletto'
13	Italian Polka	43	Burgmuller Op.100 No.15 - Ballade
14	Musette	44	Spinning Song
15	Bourree	45	In The Theatre
16	To A Wild Rose	46	Alfredo and Violetta Column Tower Duet
17	Away In A Manger	47	Come Back To Sorrento
18	Für Elise	48	Piano Sonatina In F Major
19	Marriage Of Figaro	49	Tchaikovsky Waltz
20	Angels We Have Heard On High	50	Military March No.1 In D Major
21	Waltz	51	Als die alte Mutter mich noch lehrte singen
22	America The Beautiful	52	Etude on Leger Lines 1
23	Did You Ever See A Lassie	53	Etude on Leger Lines 2
24	Arabesque	54	At the Ball
25	Old France	55	Dancing Raindrops
26	Santa Claus Is Coming To Town	56	From a Story Book
27	Music Box Dancer	57	Comin' 'Round the Mountain
28	Symphony No.9 In E Minor Largo From 'The New World'	58	Song of the Brook
29	Larghetto	59	Puck
30	French Suites	60	Cotton-pickin' Fingers

### Demo song

No.	Name
1	Fantasia



## 10 MIDI implementation chart

Function		Sent	Received	Notes
Basic Channel	Default	1	ALL	
	Changed	1-16	1-16	
Mode	Default	No	Mode 3	
	Messages	No	Mode 3	
	Altered	*****	No	
Note Number		0 – 127	0 – 127	
	True voice	*****	0 – 127	
Velocity Note	Note ON	Yes, 9nH, v = 1 – 127	Yes, 9nH, v = 1 – 127	
	Note OFF	No, 9nH, v = 0	Yes, 9nH, v = 0 or 8nH, v = 0 – 127	
After Touch	Keys	No	No	
	Channels	No	No	
Pitch Bend		No	Yes	
Control Change	0	Yes	Yes	Bank Select
	1	No	Yes	Modulation
	5	No	Yes	Portamento Time
	6	Yes	Yes	Data Entry
	7	Yes	Yes	Volume
	10	No	Yes	Pan
	11	No	Yes	Expression
	64	Yes	Yes	Sustain Pedal
	65	No	Yes	Portamento ON/OFF
	66	Yes	Yes	Sostenuto Pedal
	67	Yes	Yes	Soft Pedal
	80	No	Yes	Reverb Program
	81	No	Yes	Chorus Program
	91	Yes	Yes	Reverb Level
	93	Yes	Yes	Chorus Level
	120	No	Yes	All Sound Off
121	No	Yes	Reset All Controllers	
123	Yes	Yes	All Notes Off	

## MIDI implementation chart

Function		Sent	Received	Notes
Program Change	True #	Yes *****	Yes 0 – 127	
System Exclusive		No	Yes	
System Common	Song Position Pointer	No	No	
	Song Select	No	No	
	Tune Request	No	No	
System Real Time	Clock	No	No	
	Commands	No	No	
Aux Messages	Local ON/OFF	No	No	
	ALL Notes OFF	Yes	Yes	
	Active Sensing	Yes	Yes	
	System Reset	No	Yes	

### MIDI channel modes

	POLY	MONO
OMNI ON	Mode 1	Mode 2
OMNI OFF	Mode 3	Mode 4

## 11 Technical specifications

Keyboard	88 weighted keys with hammer action and adjustable touch response
Polyphony	64-voice
Voices	26
Rehearsal songs	60
Demo songs	1
Operating elements	On / Off switch, Volume control, Start / Stop button, Piano function keys to select Voices, Demo and Rehearsal songs, Dual mode, Split mode, Tempo, Metronome, Reverb and Chorus effect, Velocity sensitivity, Transposition, Fine tune, Equalizer settings, Key Tone.
Pedals	Soft, Sostenuto, Sustain
Connections	DC IN, 2 × head phones (1/4" phone jack), AUX IN, AUX OUT, USB
Speaker	2 × 15 W
Operating supply voltage	230 V ~ (AC)
Dimensions (W × D × H)	1365 mm × 330 mm × 790 mm
Weight	37 kg

## 12 Plug and connection assignment

### Introduction

This chapter will help you select the right cables and plugs to connect your valuable equipment in such a way that a perfect sound experience is ensured.

Please note these advices, because especially in 'Sound & Light' caution is indicated: Even if a plug fits into the socket, an incorrect connection may result in a destroyed power amp, a short circuit or 'just' in poor transmission quality!

### Balanced and unbalanced transmission

Unbalanced transmission is mainly used in semi-professional environment and in hifi use. Instrument cables with two conductors (one core plus shielding) are typical representatives of the unbalanced transmission. One conductor is ground and shielding while the signal is transmitted through the core.

Unbalanced transmission is susceptible to electromagnetic interference, especially at low levels, such as microphone signals and when using long cables.

In a professional environment, therefore, the balanced transmission is preferred, because this enables an undisturbed transmission of signals over long distances. In addition to the conductors 'Ground' and 'Signal', in a balanced transmission a second core is added. This also transfers the signal, but phase-shifted by 180°.

Since the interference affects both cores equally, by subtracting the phase-shifted signals, the interfering signal is completely neutralized. The result is a pure signal without any noise interference.

### 1/4" TRS phone plug (stereo, unbalanced)



1	Signal (left)
2	Signal (right)
3	Ground

### Three-pole 1/8" mini phone jack (stereo, unbalanced)

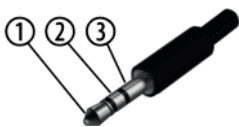

1	Signal (left)
2	Signal (right)
3	Ground, shielding

## 13 Protecting the environment

### Disposal of the packaging material



For the transport and protective packaging, environmentally friendly materials have been chosen that can be supplied to normal recycling.

Ensure that plastic bags, packaging, etc. are properly disposed of.

Do not just dispose of these materials with your normal household waste, but make sure that they are collected for recycling. Please follow the notes and markings on the packaging.

### Disposal of your old device



This product is subject to the European Waste Electrical and Electronic Equipment Directive (WEEE) in its currently valid version. Do not dispose with your normal household waste.

Dispose of this device through an approved waste disposal firm or through your local waste facility. When discarding the device, comply with the rules and regulations that apply in your country. If in doubt, consult your local waste disposal facility.





