

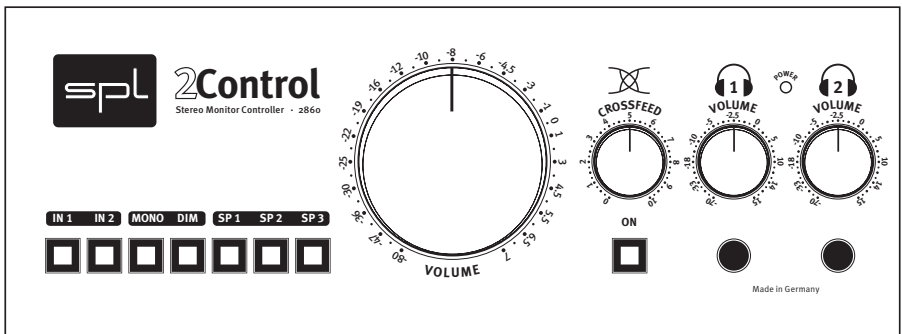

Manual



2Control

Model 2860

Version 1.2 – 11/2009

Designer: Vincenzo Triolo

This user's guide contains a description of the product. It in no way represents a guarantee of particular characteristics or results of use. The information in this document has been carefully compiled and verified and, unless otherwise stated or agreed upon, correctly describes the product at the time of packaging with this document.

Sound Performance Lab (SPL) continuously strives to improve its products and reserves the right to modify the product described in this manual at any time without prior notice. This document is the property of SPL and may not be copied or reproduced in any manner, in part or fully, without prior authorization by SPL.

SPL electronics GmbH

Sohlweg 80, 41372 Niederkruechten, Germany

Phone +49 (0)2163 983 40

Fax +49 (0)2163 983 420

E-Mail: info@spl.info

Internet: www.spl.info

The construction of the 2Control, Model 2860, is in compliance with the standards and regulations of the European Community.



Notes on Environmental Protection

At the end of its operating life, this product must not be disposed of with regular household waste but must be returned to a collection point for the recycling of electrical and electronic equipment. The wheelee bin symbol on the product,  user's manual and packaging indicates that. The materials can be re-used in accordance with their markings. Through re-use, recycling of raw materials, or other forms of recycling of old products, you are making an important contribution to the protection of our environment. Your local administrative office can advise you of the responsible waste disposal point.

WEEE Registration: 973 349 88

© 2009 SPL electronics GmbH. All rights reserved. Names of other companies and their products are trademarks of their respective owners.

Symbols And Notes, Scope of Delivery	4
Important Security Information	5
Hook Up	7
Introduction	8
Speakers or headphones?	9
Applications	10
The speaker and headphone monitoring center, Analog volume control for your DAW, Two excellent headphone amplifiers, Extend the range of headphone applications, High-grade balancing stages, Separate mono speaker output	10
Connections	11
Wiring	11
Rear Panel/Switches & Connections	12
Voltage Selector	12
Power Connection, Power Switch, GND Lift Switch, Input Sensitivity IN 2	13
XLR Sockets, Unbalanced Connections (i. e. RCA, TS Jack)	14
Front Panel/Connections	15
Headphone connection, Recommendations, Warning	15
Control Elements	16
IN 1 and IN 2 Switches, Mono, Dim, Volume Control (Speakers)	16
Calibration of the Monitoring System	17
Crossfeed	18
Headphone Volume Controls 1 and 2, Optimal Control Range of the Potentiometers, Protect your Hearing	19
Specifications	20
Block Diagram	21
Copy Master: Recall Settings	22
Guarantee	23

Symbols and Notes



Symbols And Notes

IN THIS MANUAL A LIGHTNING SYMBOL WITHIN A TRIANGLE WARNS YOU ABOUT THE POTENTIAL FOR DANGEROUS ELECTRICAL SHOCKS – WHICH CAN ALSO OCCUR EVEN AFTER THE MACHINE HAS BEEN DISCONNECTED FROM A POWER SOURCE.



AN EXCLAMATION MARK (!) WITHIN A TRIANGLE IS INTENDED TO MAKE YOU AWARE OF IMPORTANT OPERATIONAL ADVICE AND/OR WARNINGS THAT MUST BE FOLLOWED. BE ESPECIALLY ATTENTIVE TO THESE AND ALWAYS FOLLOW THE ADVICE THEY GIVE.



The symbol of a lamp directs your attention to explanations of important functions or applications.

Attention

Do not attempt any alterations to this machine without the approval or supervision of SPL electronics GmbH. Doing so could nullify completely any and all of your warranty/guarantee rights and claims to user support.

Scope of Delivery

- 2Control, Model 286o
- This manual
- Power cord

Important Security Information

Please note and retain this manual. Carefully read and follow all of the safety and operating instructions before you use the machine. Be doubly careful to follow all warnings and special safety instructions noted in this manual and on the unit.

Connections: Only use the connections as described. Other connections can lead to health risks and equipment damage.

Water and humidity: Do NOT use this machine anywhere near water (for example near a wash basin or bath, in a damp cellar, near swimming pools, or the like). In such cases there is an extremely high risk of fatal electrical shocks!



Insertion of foreign objects or fluids: NEVER allow a foreign object through any of the machine's chassis openings. You can easily come into contact with dangerous voltage or cause a damaging short circuit. NEVER allow any fluids to be spilled or sprayed on the machine. Such actions can lead to dangerous electrical shocks or fire!

Opening the Unit: Do NOT open the machine housing, as there is great risk you will damage the machine, or – even after being disconnected – you may receive a dangerous electrical shock!

Electrical power: Run this machine ONLY from sources which can provide proper power at the prescribed rating. When in doubt about a source, contact your dealer or a professional electrician. To be sure you have isolated the machine, do so by disconnecting the power cord from your wall connection. Be sure that the power cord plug is always accessible. When not using the machine for a longer period, make sure to unplug it from your wall power socket.

Power cord protection: Make sure that your power cord is arranged to avoid being stepped on or any kind of crimping and damage related to such event. Do not allow any equipment or furniture to crimp this power cord.

Power connection overloads: Avoid any kind of overload in connections to wall sockets, extension or splitter power cords. Always keep manufacturer warnings and instructions in mind. Overloads create fire hazards and risk of dangerous shocks!

Lightning: Before thunderstorms or other severe weather, disconnect the machine from wall power (but to avoid life threatening lightning strikes, not during a storm). Similarly, before any severe weather, disconnect ALL the power connections of other machines and antenna and phone/network cables which may be interconnected so that no lightning damage or overload results from such secondary connections.

Important Security Information



Air circulation: Chassis openings offer ventilation and serve to protect the machine from overheating. NEVER cover or otherwise close off these openings. NEVER place the machine on a soft surface (carpet, sofa, etc.). Make sure to provide for a mounting space of 4-5 cm/2 inches to the sides of the unit when mounting the unit in racks or cabinets.

Controls And switches: Operate the controls and switches only as described in the manual. Incorrect adjustments outside safe parameters can lead to damage and unnecessary repair costs. Never use the switches or level controls to effect excessive or extreme changes.

Repairs: Unplug the unit and immediately contact a qualified technician when you think repairs are needed – or when moisture or foreign objects may accidentally have gotten in to the housing, or in cases when the machine may have fallen and shows any sign of having been damaged. This also applies to any situation in which the unit has not been subjected to any of these unusual circumstances but still is not functioning normally or its performance is substantially altered.

In cases of damage to the power cord or its plug, first consider turning off the main circuit breaker before unplugging the power cord.

Replacement/substitute parts: Be sure that any service technician uses original replacement parts or those with identical specifications as the originals. Incorrectly substituted parts can lead to fire, electrical shock, or other dangers, including further equipment damage.

Safety inspection: Be sure always to ask a service technician to conduct a thorough safety check and ensure that the state of the repaired machine is in all respects up to factory standards.

Cleaning: In cleaning, do NOT use any solvents, as these can damage the chassis finish. Use a clean, dry cloth (if necessary, with an acid-free cleaning oil). Disconnect the machine from your power source before cleaning.

Be very careful to check that the rear chassis power selection switch is set to the correct local line voltage position before using the unit (230V position: 220-240V/50Hz, 115V position: 110-120V/60Hz)!

When in doubt about a source, contact your dealer or a professional electrician.



Before connecting any equipment make sure that any machine to be connected is turned off. Follow all safety instructions from page 5.

Place the unit on a level and stable surface. The unit's enclosure is EMC-safe and effectively shielded against HF interference. Nonetheless, you should carefully consider where you place the unit to avoid electrical disturbances. It should be positioned so that you can easily reach it, but there are other considerations. Try not to place it near heat sources or in direct sunlight, and avoid exposure to vibrations, dust, heat, cold or moisture. It should also be kept away from transformers, motors, power amplifiers and digital processors. Always ensure sufficient air circulation by keeping a distance of 4-5 cm/2 inches to the sides of the unit.

Before You Begin

Make sure all volume controls are turned hard left before you power up the unit. Now control volume. Note that too high levels can damage speakers, headphones and hearing!



Introduction

The 2Control combines loudspeaker and headphone monitoring in a compact, user-friendly and high quality control device. Any studio based on a digital audio workstation (DAW) can benefit from its important and essential monitoring functions. The concept of the 2Control is based on a dual-channel operation that allows for connection of two sources, two stereo speaker sets and two headphones.

The advantages of an analog monitoring controller becomes especially apparent in combination with modern audio and video production tools such as ProTools™, Nuendo™, Cubase™, Logic™, Deck™, etc. Monitor levels and source management can be handled independently of the software and with virtually no loss in quality. You no longer need to set up additional aux sends for monitoring. In addition, you won't have to worry about over- or underdriving the converters when changing monitor levels.

The high-quality 2Control speaker volume potentiometer and active circuits correspond with the high demands in professional audio applications regarding sound quality and usability. In contrast to passive circuits, the 2Control's active designs do not influence impedances when levels change. Altering impedances would again have effects on the frequency response, so the 2Control's active design guarantees linearity. Often there is the need to “zoom” into audio material when listening to quiet passages or checking for artifacts etc. – and only active designs offer signal amplification.

Each of the three speaker outputs (2 x stereo, 1 x mono) is driven by its own balancing stage to exclude signal degrading mutual influences. Each headphone output is supplied by a separate amplifier to allow for completely independent operation of two headphones without any interaction from the other output.

There is more than meets the eye in working with headphones. One reason for this is that modern audio production often necessitates decentralized processes. In turn, many musicians or producers might wish to – or be able to – mix at home (to say nothing of having to). Then the headphone becomes a clear must, enabling an evening or late night session that can only take place thanks to its being unhindered by the local acoustic environment.

Now each and every careful headphone user should know about the analytical advantages of headphone monitoring, but also about the main disadvantage: the difficulty (if not impossibility) in properly judging room ambience.>

Crossfeed

A new feature of the 2Control is the CROSSFEED control for both headphone outputs, which was derived from the high-end headphone amplifier *Phonitor*. From their principle, headphones have the disadvantage of producing a 180 degree stereo panorama – the CROSSFEED control can be used to adjust a stereo panorama that corresponds to a stereo speaker image. Based upon the imaging of a speaker set positioned on angle of 30 degrees towards the listener, the crosstalk of both channels can be regulated to meet individual demands. Whenever speaker monitoring may not be possible or if an monitoring alternative to speakers is required, the 2Control allows for judging mixes also on headphones.

Source and speaker output switches as well as mono and dim switches provide the main monitoring functions for a complete controller – without overloading user interface and electronics.

Speakers or headphones?

The 2Control encompasses advantages of both kinds of monitoring methods: On one hand the analytical headphone monitoring is like working with an acoustic magnifier but without external room influences; on the other hand, loudspeaker monitoring forgoes the microscopic effect, but provides for room ambience.

Working with the magnifier effect of headphones has the advantage of safely hearing clicks or similar defects and helps in fine tuning crossfades or to judge tonal problems in individual tracks. On loudspeakers such analyses are much more difficult, as such problems just are not as apparent when one is working without being able to “zoom in” aurally.

Conversely, loudspeakers provide monitoring with the advantage of spatial balance in a (definable through placement) stereo width, which in turn provides the illusion of an acoustic stage.

With the analog Crossfeed control you can match headphone listening to speaker listening. The range of headphone applications becomes much broader and you may find more or new scenarios in your working life.



The speakers and headphones monitoring center

The 2Control combines loudspeaker and headphone monitoring in a compact, user-friendly and high quality control device. Control near-field monitors, full-range speakers and headphone monitoring for two listeners from one central unit!

Analog volume control for your DAW

A majority of D/A converters and sound cards provide nothing in the way of analog level monitoring control, and this means the necessity of varying signal levels at the converter outputs. The result is a lowered bit rate in the monitoring signal, which can lead to commensurate loss of audio quality.

Two excellent headphone amplifiers

Friends, colleagues, customers: in the end there's always someone else who wants to listen in, too. With the 2Control you also have the second headphone under control – and can rely on first-class quality.

Extend the range of headphone applications

At home, nocturnal engineers now have an alternative to full range monitors for judging stereo imaging in their mixes. Furthermore, the headphone monitoring is not restricted for analytical listening only, but can serve as full stereo monitoring alternative. And the compact housing makes it easy to transport the 2Control to have familiar monitoring conditions at foreign places.

High-grade balancing stages

We use custom made balancing stages to drive long distances reliably and for first class common mode rejection values. Note that only balanced connections exclude hum and interferences. We recommend employing balanced connections wherever possible – especially connections over long distances (e. g. to speakers).



Separate mono speaker output

In addition to two stereo speaker sets you can also connect a mono speaker or a subwoofer.

Tip for working with headphones: Listen with subwoofer to enjoy the physical impact of the low end.

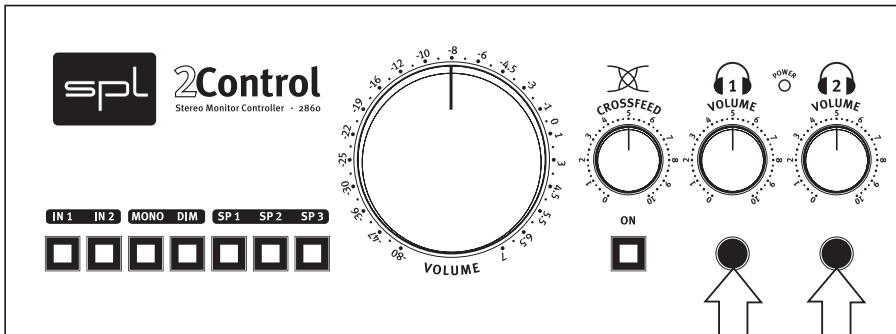

Two headphones



2nd stereo source (e. g. player)



DAW

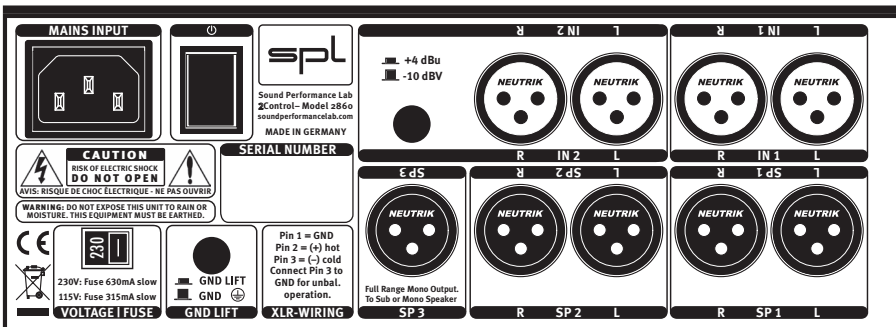

Mono speaker/
subwoofer

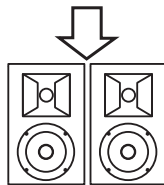

Stereo speakers
set 2

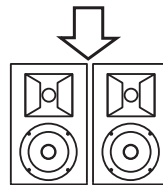

Stereo speakers
set 1

Rear Panel/Switches & Connections

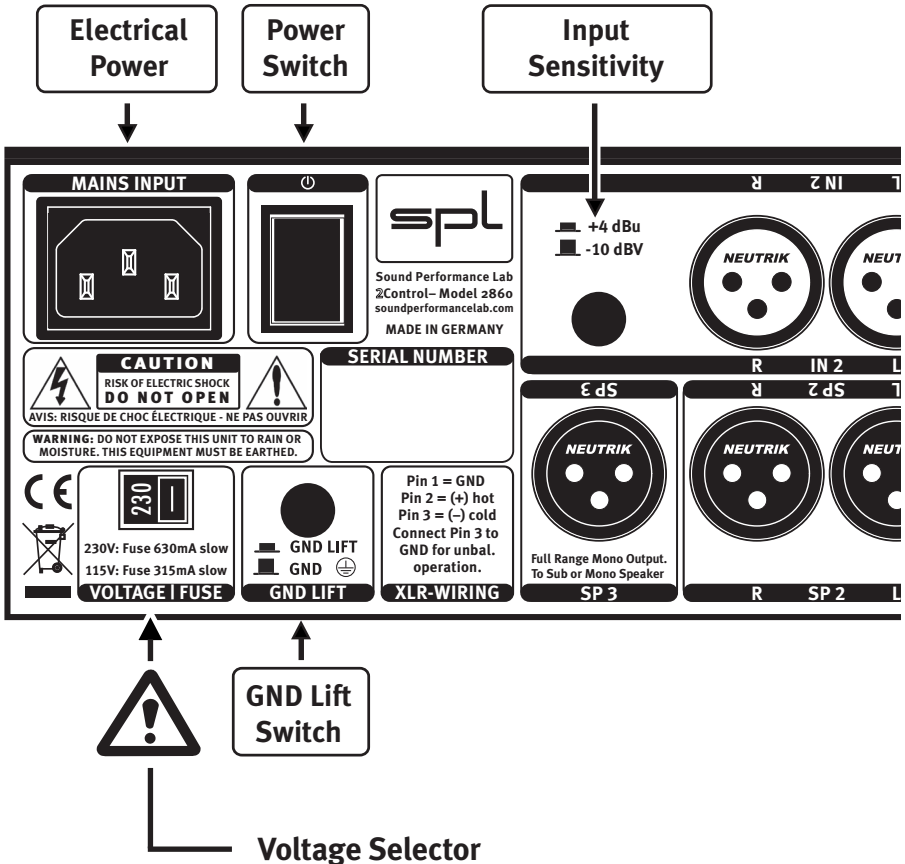

Voltage Selector

The rear panel VOLTAGE SELECTOR serves to let you switch to the local line voltage standard (115V position: 110-120 volts/60 Hz, 230V position: 220-240 volts/50 Hz). The diagram above shows the correct switch position for 230V power supply.

BEFORE you connect electrical power make sure that the **VOLTAGE SELECTOR** setting reflects the correct local power line voltage!

Rear Panel/Switches & Connections

Power Connection

Connect the included power cord to the rear Mains Input. Transformer, power cord and case connection conform to VDE, UL and CSA requirements. Power fuse ratings are 315 mA slow blow (220-240 volts) or 630 mA slow blow (110-120 volts).

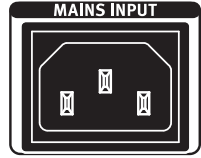

Power Switch

The rear panel POWER switch activates the unit, confirmed by the Power LED on the front panel (between the headphone symbols).



IMPORTANT ADVICE: Switch on the unit only after you have turned all VOLUME controls fully left, and wait to set your desired volume level until the unit is powered on. Neglecting this can damage either or both your ears and your headphones!

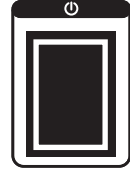

GND LIFT Switch

The rear panel GND LIFT switch eliminates hum by separating the internal ground from the unit's housing ground. Hum can, for example, result when this unit's housing has a common ground connection with other machines that might have a different ground potential.

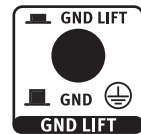

Input Sensitivity IN 2

Inputs IN 1 and IN 2 are gauged to analog line level signals at +4 dBu. The second input IN 2 can alternatively be set to another input sensitivity of -10dBV nominal level with the switch next to the IN2 inputs. A nominal level of +4 dBu represents the international standard of professional studio equipment, -10dBV corresponds to the standard in consumer electronics, for example a CD/DVD-Player for home use.

If the switch is actuated, IN 2 is set to +4 dBu, if the switch is not actuated, sensitivity of IN 2 is set to -10 dBV. If you connect a unit adjusted to -10dBV to a +4 dBu input, the signal is too quiet (and too loud vice versa). In this case change the switch position accordingly.



Rear Panel/Switches and Connections



XLR Sockets

Switch off the unit before you begin the process of making the first or any subsequent connections (rear panel power switch). Neglecting this can damage either or both your ears and your headphones!

Connect the monitoring signal(s) to the XLR sockets of the first or second input IN 1 and IN 2 (A/D converter outputs of DAWs and interfaces or playback devices).

Connect your speakers to the XLR sockets of outputs SP1, SP2 or SP3. SP1 and SP2 are supposed to feed stereo pairs, SP3 delivers a mono signal by summing left and right channel. Aside from mono speakers you can also connect a subwoofer to SP3.

Unbalanced Connections (i. e. RCA, TS Jack)

You can establish unbalanced connections easily and without adaptors – for example from CD-Players with RCA outputs or to (HiFi) power amplifiers with RCA inputs. It is important to pay attention to the correct polarity of the three XLR wires. The diagram shows the pin wiring of all XLR sockets as well as the correct polarity to establish unbalanced connections:

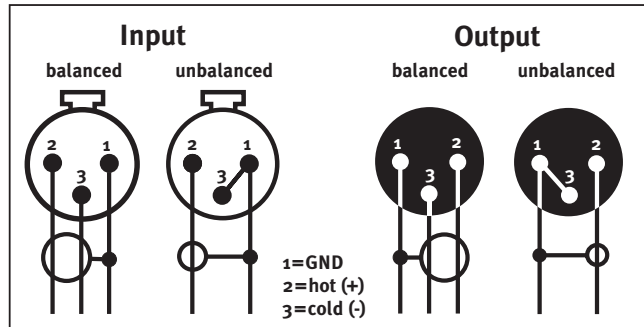

Connections to RCA and TS Jack inputs or outputs are always unbalanced. Connections to TRS inputs or outputs may be balanced or unbalanced. In any case we recommend to use readily configured cables from XLR to the respective RCA or TS/TRS connector to dispense with adaptors. Ask your dealer for configured cables. With the diagram above any audio expert can ensure to select or configure the right cables for connections from the 2Control to any other device.

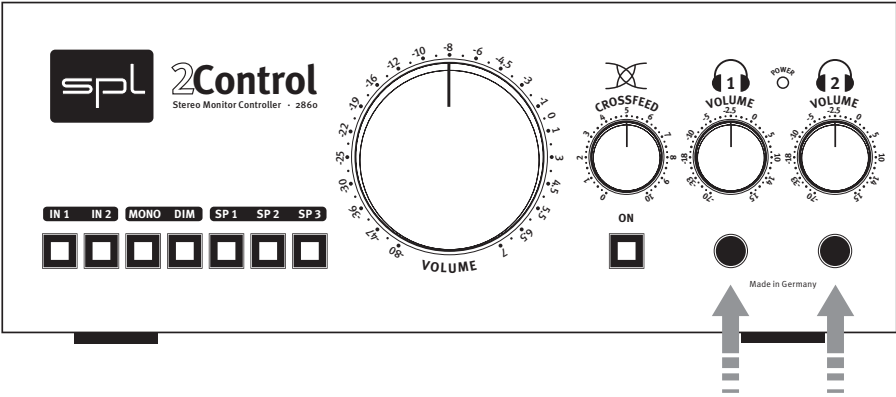

Headphone Connection

Connect headphones to the standard 1/4" (TRS) stereo jack plugs on the front panel.

The layout is: Tip = left channel, Ring = right channel, Sleeve = ground.

Make sure that the plug is firmly seated for a solid connection.

Recommendations

Reduce volume level or press DIM before you remove or plug in a headphone (or when switching headphones). This excludes louder clicks and pops reaching the ear. In addition, this can avoid the unpleasant surprise that follows when a headphone's lower impedance suddenly reproduces an otherwise acceptable 2Control volume setting of a first headphone at a much higher – even painful – level.



Warning

NEVER plug in a mono 1/4" jack (TS) to the headphone output. The use of a mono 1/4" will lead to a short-circuit that will destroy the final amplifier stage! Standard headphone connectors always have stereo plugs, and thus a correct connection will be assured when you only connect headphones directly. Double check that you use stereo 1/4" TRS plugs when you connect headphones via patchbays or extension cables etc.



Control Elements

IN 1 **IN 2**



IN 1 and IN 2 Switch

With IN 1 and IN 2 you select the source to listen to on speakers and headphones. Like all switches they illuminate after activation so that you can easily see which source is selected. Activation of both switches sums the input signals.

Mono

The MONO switch creates a sum of the left and right channel, so you can listen to stereo sources also in mono on speakers and headphones. You can also listen to a mono source on both monitoring channels.

MONO **DIM**



The MONO switch is of course also important and useful to examine the mono compatibility of a mix. Phase alterations or reversionations that may not be too obvious in the stereo panorama can be detected more clearly in a mono sum – in extreme cases they lead to cancellations.

Dim

The DIM function reduces the listening level (Volume) by around 15 dB. Normally you employ this function when mixing to choose between two defined volumes to avoid having to move the VOLUME control.

Volume Control (Speakers)

The VOLUME level control allows you to increase or decrease the signal level of both channels for all speaker outputs (SP1, SP2 and SP3). The VOLUME control is calibrated in a relative dB scale that references the input level. At the 0 dB position the input signal is led to the output with an unaltered level (unity gain).

The VOLUME potentiometer covers a control range from -80 dB to +7 dB. Thanks to the signal amplification you can listen louder to quiet passages and in general better check the material if you are hearing for acoustical problems (artifacts, noise etc.).

Calibrate the whole monitoring system (refer to page 17) so that the effectively used control range is always somewhere between the 8 and 4 o'clock positions. In this case, the potentiometer is working optimally and you insure a well-aligned, low-noise gaining for the whole monitoring chain. →

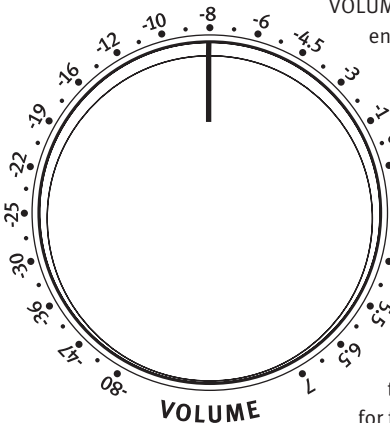

The high-grade potentiometer regulates the audio signal directly to avoid any coloration/distortion typical of VCAs, DCAs, etc., which require higher inter-channel tolerances and tend toward higher distortion figures. Moreover, this potentiometer possesses an optimal rotational torque and “feel” for precise hand control.

Calibration of the Monitoring System

Both the signal level which is sent to the 2Control as well as the input sensitivity of the power amps or active speakers should be matched to ensure a proper overall gain. An inappropriate adjustment might occur when, for example, a fairly small volume level setting at the 2Control might already result in an extremely high playback level.

Important: You can encounter very loud signals during calibration, so be sure to keep your ear protection on. For calibration we recommend measurement with a SPL Meter (in this case, SPL means “Sound Pressure Level”). Place the measuring microphone on the listening position run pink noise from a generator calibrated to 0dBu.

Each measurement should be done through one channel and loud-speaker at a time. A recommendable calibration is the playback of a 83 dB SPL reference signal at the playback location—a common reference volume level. The DAW output level should be adjusted to 0dB, and next, the power amp’s or active speaker’s input level should also be set to 0dB. Now the 2Control level control is adjusted until the SPL Meter measures 83 dB with the pink noise playback. For a perfectly matched gaining the VOLUME control would now be set above a 12 o’clock scale position. At this point one can record or note the exact value for 83 dB. Should this 83 dB SPL occur markedly above a 60-80% scale position, one should lower the power amp’s/active speaker’s input sensitivity. On the other hand, the power amp’s/active speaker’s input sensitivity should be raised if the 83 dB SPL point is reached far before the 60% control level. In cases where regulating power amp/active speaker inputs is not enough, one may achieve optimal values by changing the D/A converter output level (for example from +4 dBu to 0dBu or -10dBV in cases where this switch option may exist). In any case, the converters should always be driven at full scale from the DAW.

Please also note that you can adjust sensitivity of IN2 for other sources (refer to „Input Sensitivity IN2“ on page 13).



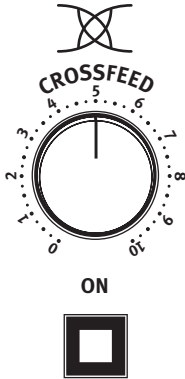

Crossfeed

The CROSSFEED control interacts with a complex analog circuitry that – simply put – serves to simulate the listening experience from loudspeakers on headphones. The ON switch below the control activates and deactivates the circuitry. CROSSFEED regulation is always applied to both headphone outputs simultaneously and is present at the headphone outputs only (no effect on the speaker outputs).

Adjustments can be made between a minimum and maximum value. The more you turn the control to the right, the more of the headphone’s super stereo width is reduced – in a maximum setting almost up to a mono signal impression.

Adjusting CROSSFEED is an individual process. Depending on headphones, music, individual preferences etc., your CROSSFEED adjustment simply should achieve the most significant advantage in monitoring your stereo mixes. We recommend comparing CROSSFEED settings to your own speaker monitors in order to get a familiar imaging – this ensures coherent conditions in speaker and headphone monitoring.

The circuitry for the CROSSFEED control is derived from the reference headphone amplifier *Phonitor*. In the *Phonitor*, the loudspeaker imaging simulation is realized with three controls: Crossfeed, Speaker Angle and Center Level. The *Phonitor* Crossfeed control allows to adjust the frequency-dependent crossfeed simulation of both channels by adjustments of interaural *level difference*. The Speaker Angle switch provides for frequency-dependent simulation of your stereo image width by adjustments of interaural *time difference*. Finally, with Center Level you can adjust the intensity of center signals – the relation between center and side signals changes when the super stereo width is transferred to a stereo image that is equivalent to loudspeakers.

For the 2Control the parameters “Speaker Angle” and “Center Level” are adjusted to a simulated speaker angle positioning of 30 degrees (the standard speaker angle) at the respective CROSSFEED settings.*

* also refer to Dipl.-Ing. Eberhard Sengpiel, <http://www.sengpielaudio.com/LaufzeitdifferenzenBeimNatuerlichenHoeren.pdf>.

Headphone Volume Controls 1 and 2

With these two detented controls you regulate the amplification of the headphone signals. Output and amplification specifications allow operation with a wide variety of headphones from ranges 30 to 600 Ohms. The 2Control provides two separate headphone amplifiers. This excludes mutual influences while VOLUME controls are independent from each other as well as from speaker volume. For further details on connecting headphones please refer to “Headphone Connection“ on page 15.

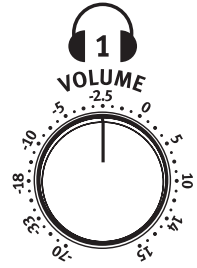

Optimal Control Range of the Potentiometers

The control range of the headphone volume covers a very large bandwidth in order to provide a production tool that simply works with all headphones. You can listen to loud levels with 30 Ohm headphones and you can “zoom” into quiet passages with 600 Ohm headphones. In order to achieve this large bandwidth, we can not guarantee that the potentiometers run with perfect left/right alignment already at the very first few clicks. This is component-related and no design flaw or damage. A reduction of overall amplification would decrease audible tolerances at the start of the control range, but it also would reduce the overall amplification which may be needed when listening to low level signals in a mix. Use the control range above scale position “1” for critical listening to remain within the optimal control range of the potentiometer.

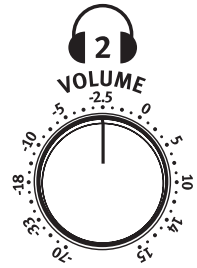

Protect your Hearing

Always reduce volume before you put on headphones or before you remove or plug in the headphone. This excludes louder clicks and pops reaching the ear. In addition, this can avoid unpleasant surprise that follows when a headphone’s lower impedance suddenly reproduces a much higher – even painful – level.

Always take care of your hearing when monitoring – especially with headphones. Reduce volume all the time as far as possible and expose your hearing to higher volumes only for short periods. As an orientation: German laws oblige ear protection in the professional area if the hearing is exposed to more than 85 dB sound pressure level – this level can already damage the hearing in the long term.

The 2Control can produce sound pressure levels that may be dangerous for your hearing because the large impedance scale of headphones requires a large performance range. Always regulate volume by starting from the zero position especially when you start working or switch headphones.

Specifications

Inputs & Outputs

Electronically balanced instrumentation amplifiers

Input sockets:	XLR
Output sockets:	XLR (rear), TRS (front)
Nominal input level:	IN 1: +4 dBu, IN 2: +4 dBu/-10 dBV
Input impedance:	22 kOhm
Output impedance:	75 Ohm/Headphones: 22 Ohm
Max. input level:	21,3 dBu
Max. output level:	21,3 dBu
Volume control range:	-80 dB to +6,6 dB Headphones: -65 dB to +14,9 dB

Measurements

Frequency range:	10 Hz to 200 kHz, -3 dB
CMRR: <i>(@1 kHz, 0 dBu input level, unity gain)</i>	> 60 dB
THD & N: <i>(@1 kHz, 0 dBu input level, unity gain)</i>	0,002 %
Signal to noise ratio: <i>(A-weighted)</i>	-96 dB/Headphones: -85 dB
Crosstalk L/R: <i>(@ 1 kHz)</i>	> 70 dB
Dynamic range:	116 dB
Power consumption:	ca. 25 W

Power Supply

Features:	Toroidal transformer with voltage selector
Fuses (slow blow):	230 V/50 Hz: 315 mA 120 V/60 Hz: 630 mA

Dimensions and Weight

Housing (B x H x T):	215 x 80 x 220 mm
Depth w. controls & sockets:	245 mm
Height with feet:	95 mm
Front height w. opened feet:	126 mm
Weight:	2,1 kg

Note: 0 dBu = 0,775 V. Specifications are subject to change without notice.

Block Diagram

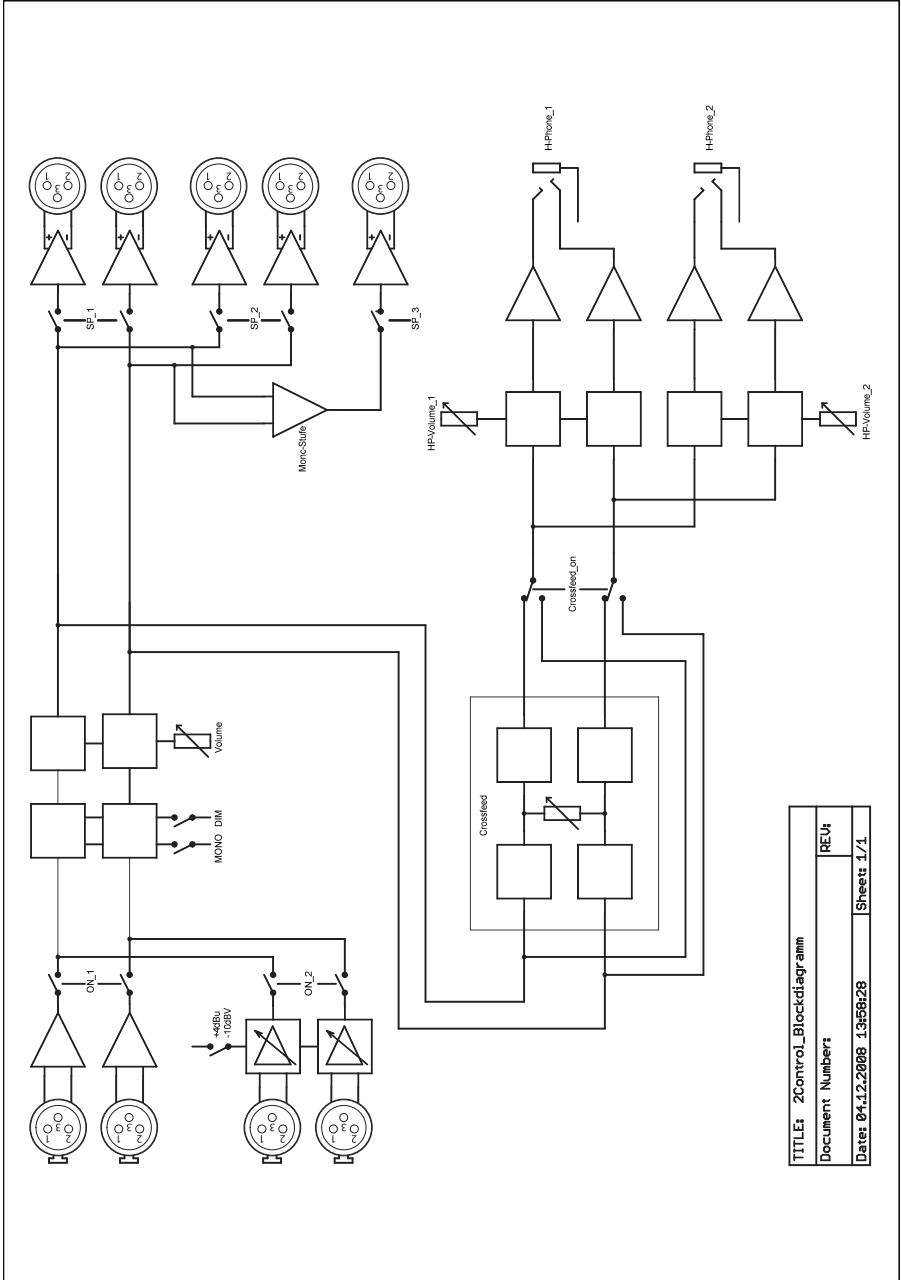

TITLE: 2Control_BlockDiagram	REV:
Document Number:	Sheet 1/1
Date: 04.12.2008 13:58:28	



Copy Master: Recall Settings

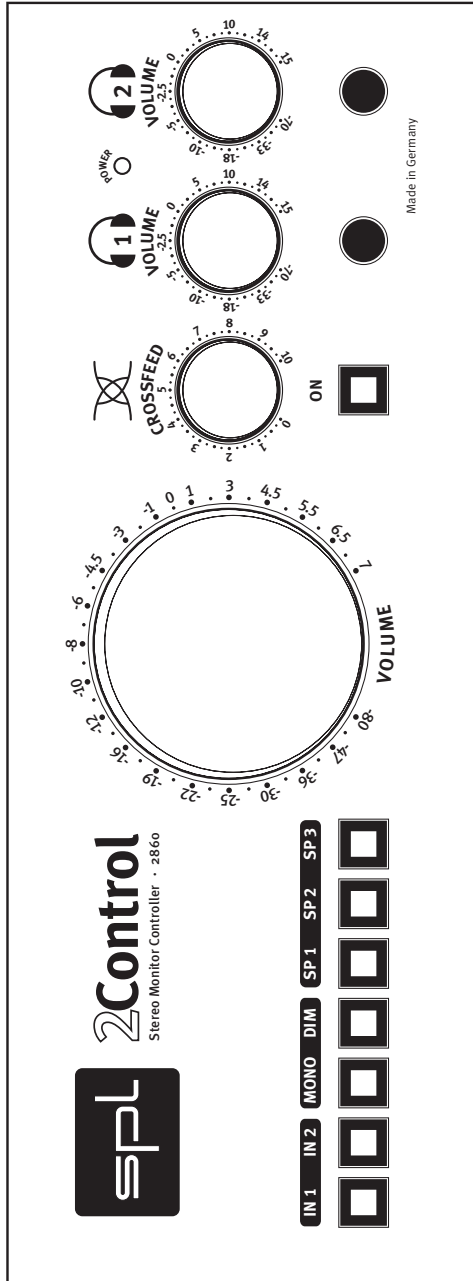

Made in Germany

Please note the terms on the supplied guarantee card.

Direct SPL product support requires product registration. Please fill out the guarantee card in printed letters and send it directly to SPL. Or use the **online registration** form that may be reached at **www.spl.info**.

