

KEY FEATURES

- Real 900 W AES power handling
- Sensitivity: 96 dB @ 2.83V
- 4" duo technology voice coil
- Forced air convection circuit for low power compression
- Extended controlled displacement: $X_{max} \pm 8$ mm.
- Massive mechanical displacement capability: 52 mm p-p



GENERAL DESCRIPTION

This model is the result of an extensive and intense research of every single constituent part of an electro-dynamic loudspeaker, rethinking the basics and taking care of every detail, to withstand the extreme power conditions it has been designed to work in. All this investigation is reflected in the new and innovative technologies developed by Beyma and applied in this new transducer.

DUO TECHNOLOGY 4" VOICE COIL

- Laminated former combining two different advanced technology materials to enhance the voice coil life.
- Voice coil winding coiled over the two faces of the former.
- Double insulation paper (inner and outer) for optimum force transmission.
- Superficial treatment of the voice coil winding to provide further protection to the voice coil wire.

HEAT DISSIPATION

- Low power compression due to the use of a forced convection mechanism.
- This design has been optimized with the extensive use of miniature high temperature probes and real-time temperature acquisition systems, together with a thermographic camera to obtain real images of the heat distribution in the voice coil and forced convection effects.

MOVING ASSEMBLY

- High stiffness weather resistant paper cone.
- Beyma Double Conex Spider technology (D.C.S.): the conex is a fireproof material that insures the preservation of the spider mechanical properties under extreme power conditions.
- Beyma Mechanical Mirror Suspension System (M.M.S.S.): the diaphragm surround and the double spider have been carefully designed with the assistance of Finite Element calculations in order to match coherently, enabling long and controlled cone displacements.

UNDER-POLE NEODYMIUM MAGNET TOPOLOGY

- F.E.A. optimized under-pole magnet topology. This geometry maximizes the flux density in the air-gap and completely eliminate the leakage magnetic field, avoiding any possible magnetic interference with other equipment.
- High temperature neodymium magnets.

FREQUENCY RESPONSE AND DISTORTION CURVES

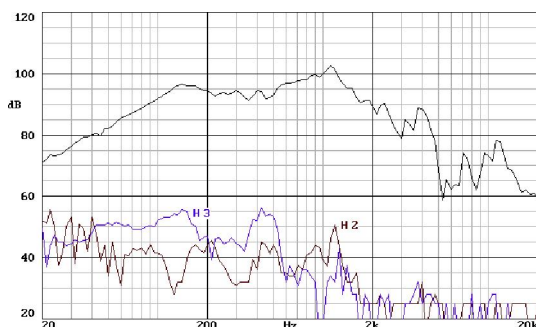

Note: on axis frequency response measured with loudspeaker standing on infinite baffle in anechoic chamber, 1w @ 1m.

FREE AIR IMPEDANCE CURVE

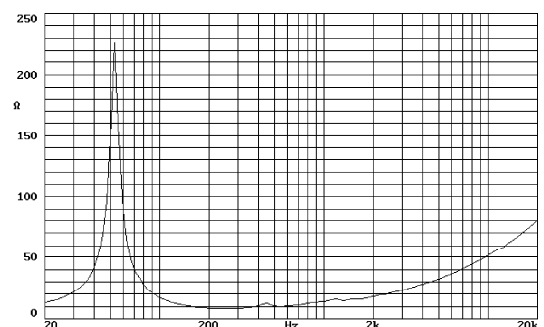

TECHNICAL SPECIFICATIONS

Nominal diameter	300 mm. 12 in.
Rated impedance	8 ohms
Minimum impedance	6.5 ohms
Power capacity*	900 w AES
Program power	1800 w
Sensitivity	96 dB 2.83v @ 1m @ 2π
Frequency range	30 - 2500 Hz
Recom. enclosure vol.	20 / 60 l 0.7 / 2.24 ft. ³
Voice coil diameter	100 mm. 4 in.
Magnetic assembly weight	4.62 kg. 10.16 lb.
BL factor	23.5 N / A
Moving mass	0.100 kg.
Voice coil length	21 mm
Air gap height	12 mm
X damage (peak to peak)	52 mm

DIMENSION DRAWINGS

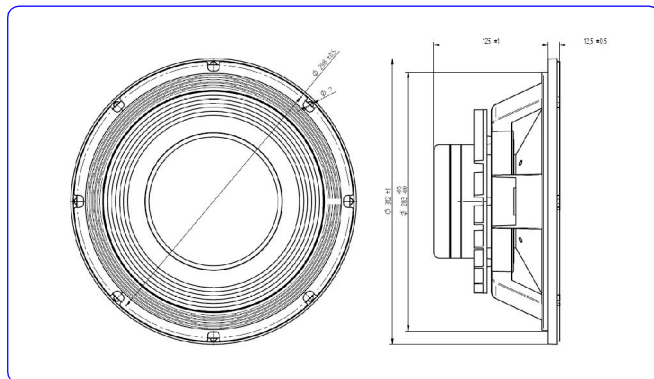

MOUNTING INFORMATION

Overall diameter	312 mm. 12.28 in.
Bolt circle diameter	298 mm. 11.73 in.
Baffle cutout diameter:	
- Front mount	283 mm. 11.14 in.
- Rear mount	280 mm. 11.02 in.
Depth	131 mm. 5.16 in.
Volume displaced by driver	4 l 0.14 ft. ³
Net weight	5.4 kg. 11.88 lb.
Shipping weight	6.1 kg. 13.42 lb.

MATERIALS

- **Basket:** Cast aluminium
- **Cone:** Paper
- **Surround:** Treated cloth
- **Voice coil:** Copper wire
- **Magnet:** Neodymium

THIELE-SMALL PARAMETERS**

Resonant frequency, fs	47 Hz
D.C. Voice coil resistance, Re	5.1 ohms.
Mechanical Quality Factor, Qms	7.89
Electrical Quality Factor, Qes	0.27
Total Quality Factor, Qts	0.26
Equivalent Air Volume to Cms, Vas	49 l
Mechanical Compliance, Cms	115 μm / N
Mechanical Resistance, Rms	3.7 kg / s
Efficiency, ηo (%)	1.8
Effective Surface Area, Sd (m ²)	0.0550 m ²
Maximum Displacement, Xmax***	8 mm
Displacement Volume, Vd	440 cm ³
Voice Coil Inductance, Le @ 1 kHz	2 mH

Notes:

*The power capacity is determined according to AES2-1984 (r2003) standard. Program power is defined as the transducer's ability to handle normal music program material.

**T-S parameters are measured after an exercise period using a preconditioning power test. The measurements are carried out with a velocity-current laser transducer and will reflect the long term parameters (once the loudspeaker has been working for a short period of time).

***The Xmax is calculated as (Lvc - Hag)/2 + Hag/3.5, where Lvc is the voice coil length and Hag is the air gap height.