



©2017 ADJ Products, LLC all rights reserved. Information, specifications, diagrams, images, and instructions herein are subject to change without notice. ADJ Products, LLC logo and identifying product names and numbers herein are trademarks of ADJ Products, LLC. Copyright protection claimed includes all forms and matters of copyrightable materials and information now allowed by statutory or judicial law or hereinafter granted. Product names used in this document may be trademarks or registered trademarks of their respective companies and are hereby acknowledged. All non-ADJ Products, LLC brands and product names are trademarks or registered trademarks of their respective companies.

ADJ Products, LLC and all affiliated companies hereby disclaim any and all liabilities for property, equipment, building, and electrical damages, injuries to any persons, and direct or indirect economic loss associated with the use or reliance of any information contained within this document, and/or as a result of the improper, unsafe, insufficient and negligent assembly, installation, rigging, and operation of this product.

## DOCUMENT VERSION

Please check [www.adj.com](http://www.adj.com) for the latest revision/update of this guide.

Date	Document Version	Software Version $\geq$	DMX Channel Mode	Notes
08/04/17	1	1.01	6/10/12/36	Initial Release

Europe Energy Saving Notice  
 Energy Saving Matters (EuP 2009/125/EC)  
 Saving electric energy is a key to help protecting the environment.  
 Please turn off all electrical products when they are not in use. To avoid power consumption in idle mode, disconnect all electrical equipment from power when not in use. Thank you!

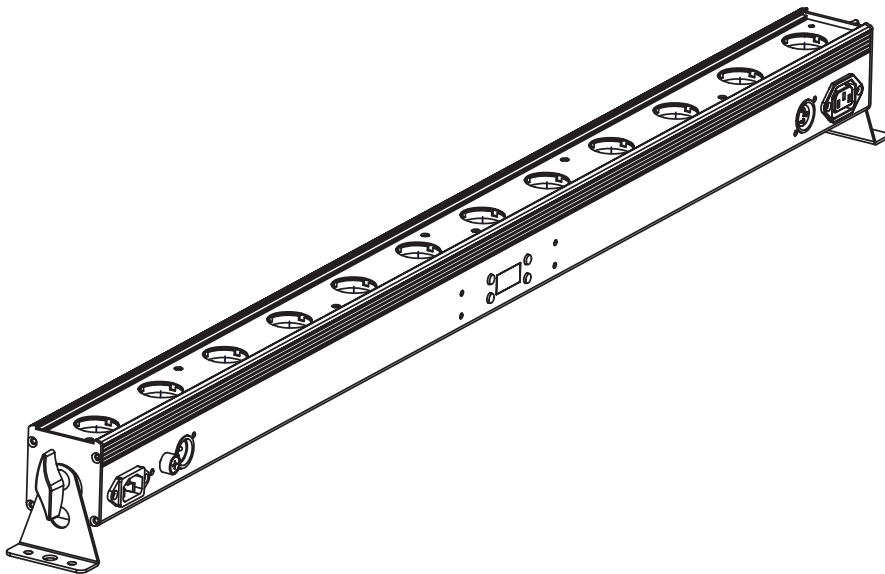

## User Instructions

## UB 12H

## Introduction

**Unpacking:** Thank you for purchasing the UB 12H by ADJ Products, LLC. Every UB 12H has been thoroughly tested and has been shipped in perfect operating condition. Carefully check the shipping carton for damage that may have occurred during shipping. If the carton appears to be damaged, carefully inspect your fixture for any damage and be sure all accessories necessary to operate the unit has arrived intact. In the case damage has been found or parts are missing, please contact our toll free customer support number for further instructions. Do not return this unit to your dealer without first contacting customer support.

**Introduction:** The UB 12H is a DMX intelligent, LED bar fixture. This fixture can be used in a stand alone mode or connected in a Master/Slave configuration. This fixture has six operating modes: Static Color mode, RGBWA+UV Dimmer mode, Program mode, Auto mode, Sound Active mode, and DMX control mode.

**Customer Support:** ADJ Products, LLC provides a customer support line, to provide set up help and to answer any question should you encounter problems during your set up or initial operation. You may also visit us on the web at [www.adj.com](http://www.adj.com) for any comments or suggestions. Service Hours are Monday through Friday 8:00 a.m. to 4:30 p.m. Pacific Standard Time.

Voice: (800) 322-6337  
Fax: (323) 582-2941  
E-mail: [support@americandj.com](mailto:support@americandj.com)

**Warning!** To prevent or reduce the risk of electrical shock or fire, do not expose this unit to rain or moisture.

**Caution!** There are no user serviceable parts inside this unit. Do not attempt any repairs yourself, doing so will void your manufactures warranty. In the unlikely event your unit may require service please contact ADJ Products, LLC.

**PLEASE recycle the shipping carton when ever possible.**

## UB 12H

## Features

- Multi-Colors
- Six Operating Modes
- Electronic Dimming 0-100%
- Built in Microphone
- DMX-512 protocol
- 3-Pin DMX Connection
- Magnetic Quick Align (See page 25)
- 4 DMX Modes: 6 Channel Mode, 10 Channel Mode, 12 Channel Mode, and 36 Channel Mode
- ADJ UC IR compatible and Airstream IR compatible
- Multiple Unit Power Linking (See page 13)

## UB 12H

## Warranty Registration

The UB 12H carries a 2 year limited warranty. Please fill out the enclosed warranty card to validate your purchase. All returned service items whether under warranty or not, must be freight pre-paid and accompany a return authorization (R.A.) number. The R.A. number must be clearly written on the outside of the return package. A brief description of the problem as well as the R.A. number must also be written down on a piece of paper included in the shipping carton. If the unit is under warranty, you must provide a copy of your proof of purchase invoice. You may obtain a R.A. number by contacting our customer support team on our customer support number. All packages returned to the service department not displaying a R.A. number on the outside of the package will be returned to the shipper.

## UB 12H

## Installation

The unit should be mounted using a mounting clamp (not provided), affixing it to the mounting bracket that is provided with the unit. Always ensure that the unit is firmly fixed to avoid vibration and slipping while operating. Always ensure that the structure to which you are attaching the unit is secure and is able to support a weight of 10 times the unit's weight. Also, always use a safety cable that can hold 12 times the weight of the unit when installing the fixture. The equipment must be installed by a professional, and it must be installed in a place where it is out of the reach of people's grasp.

- To reduce the risk of electrical shock or fire, do not expose this unit rain or moisture
- Do not spill water or other liquids into or on to your unit.
- Do not attempt to operate this unit if the power cord has been frayed or broken. Do not attempt to remove or break off the ground prong from the electrical cord. This prong is used to reduce the risk of electrical shock and fire in case of an internal short.
- Disconnect from main power before making any type of connection.
- Do not remove the cover under any conditions. There are no user serviceable parts inside.
- Never operate this unit when it's cover is removed.
- Never plug this unit in to a dimmer pack
- Always be sure to mount this unit in an area that will allow proper ventilation. Allow about 6" (15cm) between this device and a wall.
- Do not attempt to operate this unit, if it becomes damaged.
- This unit is intended for indoor use only, use of this product out doors voids all warranties.
- During long periods of non-use, disconnect the unit's main power.
- Always mount this unit in safe and stable matter.
- Power-supply cords should be routed so that they are not likely to be walked on or pinched by items placed upon or against them, paying particular attention to the point they exit from the unit.
- Cleaning -The fixture should be cleaned only as recommended by the manufacturer. See page 26 for cleaning details.
- Heat -The appliance should be situated away from heat sources such as radiators, heat registers, stoves, or other appliances (including amplifiers) that produce heat.
- The fixture should be serviced by qualified service personnel when:
  - A. The power-supply cord or the plug has been damaged.
  - B. Objects have fallen, or liquid has been spilled into the fixture.
  - C. The fixture has been exposed to rain or water.
  - D. The fixture does not appear to operate normally or exhibits a marked change in performance.

**! CAUTION**

**HIGH  
INTENSITY  
ULTRAVIOLET  
LIGHT**



**AVOID DIRECT EYE & SKIN EXPOSURE.  
WEAR PROPER EYE & SKIN PROTECTION.  
SEE MANUAL FOR SAFETY INSTRUCTIONS.**

**RISK GROUP 3 - RISK OF EXPOSURE TO ULTRAVIOLET (UV) RADIATION!**

**FIXTURE EMITS HIGH INTENSITY ULTRAVIOLET (UV) LIGHT  
AT A WAVELENGTH OF 390NM - 410NM.**

**WEAR PROPER EYE AND SKIN PROTECTION.**

**AVOID PROLONGED PERIODS OF EXPOSURE.**

**AVOID WEARING WHITE COLOR CLOTHING AND/OR  
USING (UV) PAINTS ON SKIN.**

**AVOID DIRECT EYE AND/OR SKIN EXPOSURE AT DISTANCES  
SHORTER THAN 11 feet (3.3m).**

**DO NOT OPERATE FIXTURE WITH DAMAGED OR MISSING EXTERNAL  
COVER PROTECTIVE LENS.**

**DO NOT LOOK DIRECTLY INTO THE (UV) LIGHT AND/OR VIEW (UV)  
LIGHT DIRECTLY WITH OPTICAL INSTRUMENTS THAT MAY CONCEN-  
TRATE THE LIGHT/RADIATION OUTPUT.**

**INDIVIDUALS SUFFERING FROM A RANGE OF EYE CONDITIONS, SUN-  
LIGHT EXPOSURE DISORDERS, OR INDIVIDUALS USING PHOTSEN-  
SITIVE MEDICATION, MAY RECEIVE DISCOMFORT IF EXPOSED TO THE  
ULTRAVIOLET (UV) LIGHT EMITTED FROM THIS FIXTURE.**

**Power Supply:** The ADJ UB 12H contains a automatic voltage switch, which will auto sense the voltage when it is plugged into the power source. With this switch there is no need to worry about the correct power voltage, this unit can be plugged in anywhere.

**DMX-512:** DMX is short for Digital Multiplex. This is a universal protocol used as a form of communication between intelligent fixtures and controllers. A DMX controller sends DMX data instructions from the controller to the fixture. DMX data is sent as serial data that travels from fixture to fixture via the DATA “IN” and DATA “OUT” XLR terminals located on all DMX fixtures (most controllers only have a DATA “OUT” terminal).

**DMX Linking:** DMX is a language allowing all makes and models of different manufactures to be linked together and operate from a single controller, as long as all fixtures and the controller are DMX compliant. To ensure proper DMX data transmission, when using several DMX fixtures try to use the shortest cable path possible. The order in which fixtures are connected in a DMX line does not influence the DMX addressing. For example; a fixture assigned a DMX address of 1 may be placed anywhere in a DMX line, at the beginning, at the end, or anywhere in the middle. When a fixture is assigned a DMX address of 1, the DMX controller knows to send DATA assigned to address 1 to that unit, no matter where it is located in the DMX chain.

**Data Cable (DMX Cable) Requirements (For DMX Operation):**

The UB 12H can be controlled via DMX-512 protocol. The UB 12H has 4 DMX channel modes, please see page 10 for the different modes. The DMX address is set on the back panel of the UB 12H. Your unit and your DMX controller require a standard 3-pin XLR connector for data input and data output (Figure 1). We recommend Accu-Cable DMX cables. If you are making your own cables, be sure to use standard 110-120 Ohm shielded cable (This cable may be purchased at almost all pro lighting stores). Your cables should be made with a male and female XLR connector on either end of the cable. Also remember that DMX cable must be daisy chained and cannot be split.



Figure 1

**Notice:** Be sure to follow figures two and three when making your own cables. Do not use the ground lug on the XLR connector. Do not connect the cable’s shield conductor to the ground lug or allow the shield conductor to come in contact with the XLR’s outer casing. Grounding the shield could cause a short circuit and erratic behavior.

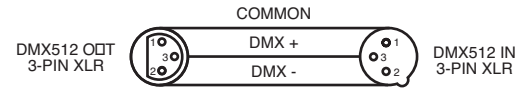

Figure 2

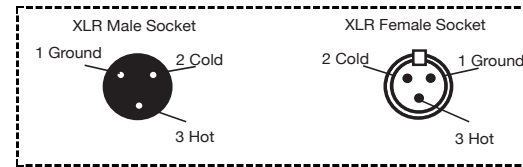

Figure 3

XLR Pin Configuration	
Pin 1	= Ground
Pin 2	= Data Compliment (negative)
Pin 3	= Data True (positive)

**Special Note: Line Termination.** When longer runs of cable are used, you may need to use a terminator on the last unit to avoid erratic behavior. A terminator is a 110-120 ohm 1/4 watt resistor which is connected between pins 2 and 3 of a male XLR connector (DATA + and DATA -). This unit is inserted in the female XLR connector of the last unit in your daisy chain to terminate the line. Using a cable terminator (ADJ part number Z-DMX/T) will decrease the possibilities of erratic behavior.



Termination reduces signal errors and avoids signal transmission problems and interference. It is always advisable to connect a DMX terminal, (Resistance 120 Ohm 1/4 W) between PIN 2 (DMX-) and PIN 3 (DMX +) of the last fixture.

Figure 4

**5-Pin XLR DMX Connectors.** Some manufactures use 5-pin DMX-512 data cables for DATA transmission in place of 3-pin. 5-pin DMX fixtures may be implemented in a 3-pin DMX line. When inserting standard 5-pin data cables in to a 3-pin line a cable adaptor must be used, these adaptors are readily available at most electric stores. The chart below details a proper cable conversion.

3-Pin XLR to 5-Pin XLR Conversion		
Conductor	3-Pin XLR Female (Out)	5-Pin XLR Male (In)
Ground/Shield	Pin 1	Pin 1
Data Compliment (- signal)	Pin 2	Pin 2
Data True (+ signal)	Pin 3	Pin 3
Not Used		Do Not Use
Not Used		Do Not Use

**LED Display On/Off:**

To set the LED display to turn off after 10 seconds, press the MODE button until “don” is displayed, press the UP button to display “doff”. Now the display will disappear after 10s. Press any button to turn the display on again. Be advised though that the display will turn off automatically after 10 seconds.

**LED Display Inversion:**

Follow these instructions to flip the display 180° so that the display can be read upside down.

1. Plug the fixture in and press the MODE button until “dXX” is displayed. “XX” represents either “on” or “oFF”.
2. Press the SET UP button until “Std” is displayed.
3. Press the UP or DOWN buttons to “flip” the display 180°.

**Operating Modes:**

The UB 12H has six operating modes:

- Static Color Mode - There are 63 colors to choose from.
- RGBWA+UV Dimmer Mode - Choose one of the 6 colors to remain static or adjust the intensity of each color to make your desired color.
- Built-In Program - There are 22 built-in programs to choose from with multiple adjustments.
- Auto Run - A auto program will run with adjustable fade speed and strobe.
- Sound-Active mode - The unit will react to sound, chasing through the built in programs.
- DMX control mode - This function will allow you to control each individual fixtures traits with a standard DMX 512 controller.

**Static Color Mode:**

1. Plug the fixture in and press the MODE button until “CLXX” is displayed.
2. There are 63 colors to choose from. Select your desired color by pressing the UP and DOWN buttons. After you have selected your desired color you can activate strobing by pressing the SET UP button to enter the Flash (strobe) mode.
3. “FS.XX” will now be displayed, this is Flash mode. The Flash can be adjusted between “FS.00” (flash off) to “FS.15” (fastest flash).

**RGBWA & UV Dimmer Mode:**

1. Plug the fixture in and press the MODE button until “r.XXX” is displayed. You are in Red dimming mode.
2. Press the UP and DOWN buttons to adjust intensity. After you have finished adjusting the intensity, or if you would like to skip to the next color, press the SET UP button.
3. When “G.XXX” is displayed you are in Green dimming mode. Press the UP and DOWN buttons to adjust intensity.
4. When “b.XXX” is displayed you are in Blue dimming mode. Press the UP and DOWN buttons to adjust intensity.
5. When “U.XXX” is displayed you are in White dimming mode. Press the UP and DOWN buttons to adjust intensity.
6. When “A.XXX” is displayed you are in Amber dimming mode. Press the UP and DOWN buttons to adjust intensity.
7. When “u.XXX” is displayed you are in UV dimming mode. Press the UP and DOWN buttons to adjust intensity.
8. After you have adjusted the colors to make your desired color you can then activate strobing by pressing the SET UP button to enter the strobe mode.
9. “FSXX” will be displayed, this is strobe mode. The strobe can be adjusted between “00” (flash off) to “15” (fastest flash).

**Auto Run Mode:**

In this mode the UB 12H will run a auto program.

1. Plug the fixture in and press the MODE button until “AUTO” is displayed.
2. After you have activated Auto Run mode, press the SET UP button to adjust the fade time.
3. Once you press SET UP “Fd.XX” should be displayed. Use the UP or DOWN buttons to set the fade speed to either “Fd.00” (fade off) or between “Fd.01” (fastest speed) and “Fd.99” (slowest speed). After adjusting the fade speed, press SET UP if you wish to activate the Flash mode.
4. “FS.XX” will now be displayed, this is Flash mode. The Flash can be adjusted between “FS.00” (flash off) to “FS.15” (fastest flash).



**Built-In Program Mode:**

1. Plug the fixture in and press the MODE button until “Pr.XX” is displayed. “XX” represents a number from 1-22. Use the UP or DOWN buttons to scroll through the 22 programs. Programs 21 and 22 have adjustable base and scrolling colors. Once you have found your desired program press the SET UP button.
2. Pressing the SET UP button will display “SP.XX”. When this is displayed you can adjust the running speed of your desired program. Use the UP or DOWN button to adjust the speed between “SP.01” (slowest) and “SP.99” (fastest). Once you have set your desired running speed, you can press the SET UP button to enter the Fade adjustment mode.
3. Pressing the SET UP button will display “Fd.XX”. When this is displayed you can adjust the fade speed of your desired program. Use the UP or DOWN button to adjust the speed between “Fd.01” (fastest) and “Fd.99” (slowest) or “Fd.00” (Off). Once you have set your desired fade speed, you can press the SET UP button to enter the Flash (Strobe) mode.
4. After pressing SET UP, “FS.XX” will be displayed, this is Flash mode. The Flash can be adjusted between “FS.00” (flash off) to “FS.15” (fastest flash).
  - **PROGRAMS 21 & 22** - If you have chosen programs 21 or 22, after the Flash mode, press the SET UP button. “C1.XX” will be displayed. This is the base color, use the UP and DOWN buttons to scroll through the 7 colors. Once you have chosen your base color, press the SET UP button again so that “C2.XX” is displayed. This is the moving color, use the UP and DOWN buttons to scroll through the 7 colors.

**Sound Active Mode:**

1. Plug the fixture in and press the MODE button until “SU.XX” is displayed. “XX” represents the sound sensitivity level.
2. Use the UP or DOWN buttons to adjust the sound sensitivity. “SU.00” is off, “SU.01” is the lowest sensitivity, and “SU.31” is the highest. After adjusting the sound sensitivity, press SET UP if you wish to activate the Flash mode.
3. “FS.XX” will now be displayed, this is Flash mode. The Flash can be adjusted between “FS.00” (flash off) to “FS.15” (fastest flash).

**DMX Mode:**

Operating through a DMX controller gives the user the freedom to create their own programs tailored to their own individual needs. This function also allows you to use your fixtures as spot lights. The UB 12H has 4 DMX modes: 6 Channel mode, 10 Channel mode, 12 Channel mode, and 36 Channel mode. See pages 15-21 for each mode’s DMX traits.

1. This function will allow you to control each individual fixture’s traits with a standard DMX 512 controller.
2. To run your fixture in DMX mode press the MODE button until “d.XXX” is displayed. “XXX” represents the current displayed address. Use the UP or DOWN buttons to select your desired DMX address, then press the SETUP button so that “Ch.XX” is displayed.
3. Use the UP or DOWN buttons to scroll through the DMX Channel modes. The Channel modes are listed below:
  - To run the 6 Channel Mode, press the MODE button until “Ch06” is displayed. This is the 6 Channel DMX Mode.
  - To run the 10 Channel Mode, press the MODE button until “Ch10” is displayed. This is the 10 Channel DMX Mode.
  - To run the 12 Channel Mode, press the MODE button until “Ch12” is displayed. This is the 12 Channel DMX Mode.
  - To run the 36 Channel Mode, press the MODE button until “Ch36” is displayed. This is the 36 Channel DMX Mode.
4. Please see pages 15-21 for DMX values and traits.
5. After you have chosen your desired DMX Channel mode plug in the fixture via the XLR connections to any standard DMX controller.

**ADJ Remote Activation:**

This function is used to activate and deactivate the IR sensor. When this function is activated you can control the fixture using either the ADJ UC IR or Airstream App. Please see page 14 for the controls and functions.

1. Plug the fixture in and press the MODE button until “dXX” is displayed. “XX” represents either “on” or “off”.
2. Press the SET UP button until “lrXX” is displayed. “XX” represents either “on” or “off”.
3. Press the UP or DOWN buttons to either activate the remote function (On) or deactivate it (Off).

**DMX State:**

This mode can be used as a precaution mode, that in case the DMX signal is lost, the operating mode chosen in the setup is the running mode the fixture will go into when the DMX signal is lost. You can also set this as the operating mode you would like the unit to return to when power is applied.

1. Plug the fixture in and press the MODE button until “d.XXX” is displayed. “XXX” represents the current displayed DMX address.
2. Press the SET UP button so that “nodn” is displayed. Use the UP and DOWN buttons to scroll through the DMX states.
  - “bLAC” (Blackout) - If the DMX signal is lost or interrupted, the unit will automatically go into stand by mode.
  - “LAsT” (Last State) - If the DMX signal is lost or interrupted, the fixture will stay in the last DMX set up. If power is applied and this mode is set, the unit will automatically go into the last DMX set up.
  - “ProG” (Auto Run) - If the DMX signal is lost or interrupted, the unit will automatically go into Auto Run mode.
3. Use the UP and DOWN buttons to find your desired DMX state and press SET UP to confirm and exit.

**Dimmer Curve:**

This is used to set the dimming curve used with DMX mode. See page 23 for the different dimming curves.

1. Plug the fixture in and press the MODE button until the current DMX address is displayed.
2. Press the SET UP button until “dr-X” is displayed. “X” represents the displayed dimmer curve (0-4).
  - 0 - Standard
  - 1 - Stage
  - 2 - TV
  - 3 - Architectural
  - 4 - Theatre
3. Press the UP or DOWN buttons to scroll through and select your desired dimming curve.

**Default Running Mode:**

This is a default running mode. When this mode is activated all modes will return to their default settings and a Auto program will run.

1. Plug the fixture in and press the MODE button until “dXX” is displayed. “XX” represents either “on” or “off”.
2. Press the SET UP button until “dEFA” is displayed.
3. Press the UP and DOWN buttons at the same time.

**Master-Slave Configuration:**

This function will allow you to link units together to run in a Master-Slave mode. In Master-Slave operation one unit will act as the controlling unit and the others will react to the controlling units built-in programs. Any unit can act as a Master or as a Slave however, only one unit can be programmed to act as the “Master.”

**Master-Slave Connections and Settings:**

1. Daisy chain your units via the XLR connector on the rear of the unit. Use standard XLR data cables to link your units together. Remember that the Male XLR connector is the input and the Female XLR connector is the output. The first unit in the chain (master) will use the female XLR connector only. The last unit in the chain will use the male XLR connector only.
2. Set the “Master” unit to your desired operating mode and then connect the “Slave” unit or units.
3. For the “Slave” unit(s) press the MODE button until “SLAu” is displayed. The “Slave” unit(s) will now follow the “Master” unit.

**With this feature you can connect the fixtures to one another using the IEC input and output sockets. The maximum that can be connected is 7 fixtures @ 120V and 13 fixtures @ 240V. After the maximum connected fixtures you will need to use a new power outlet.**

**NOTE: USE CAUTION WHEN POWER LINKING OTHER FIXTURES TO THE UB 12H AS THE POWER CONSUMPTION OF OTHER LIGHTING FIXTURES WILL VARY!**

**UB 12H****ADJ UC IR/Airstream IR Operation**

The **UC IR** infrared remote gives you control of various functions (See below). To control the fixture you must aim the remote at the front of the fixture and be no more than 30 feet away. To use the ADJ UC IR you must first activate the fixtures infrared sensor, to activate the sensor please see the instructions on page 11.

The **Airstream IR** remote transmitter plugs into the headphone jack of your iOS phone or tablet. To control your IR fixture you must raise the volume to the maximum on your iOS phone or tablet and aim the transmitter at the fixture sensor and be no more than 15 feet away. After you have purchased the Airstream IR transmitters, the app is a free download from the app store for your iOS phone or tablet. The app comes with 3 pages of control depending on the fixture you are using. Please see below for IR functions including the corresponding app page.

**Works with App page 1.**

**STAND BY** - Pressing this button will blackout the fixture. Press the button again to return to the initial state.

**FULL ON** - Press this button down to fully light up the unit. Press this button again to return the unit to its last mode of operation.

**FADE/GOBO** - This button activates fade mode. Use buttons 1-3 to adjust the fade speed.

**“DIMMER +” and “DIMMER -”** - Use these buttons to adjust the output intensity.

**STROBE** - Press this button to activate strobing. Use buttons 1-4 to adjust the strobe speed. “1” being the slowest, “4” being the fastest. Press this button again to stop strobing.

**COLOR** - Press this button to activate color mode. Use buttons 1-9 to find your desired color.

**1-9** - Use buttons 1-9 to select your desired color when color mode is active or your desired program when show mode is active. Use buttons 1-4 to select you desired strobe rate when strobing is active.

**SOUND ON & OFF** - Use the buttons to activate and deactivate sound active mode.

**SHOW 0** - Press this button to activate show mode. Use buttons 1-9 to select your desired show. Press this button twice for show 10. Press button 1 twice for show 11.

**UB 12H****6 Channel Mode**

Channel	Value	Function
1	0 - 255	RED 0% - 100%
2	0 - 255	GREEN 0% - 100%
3	0 - 255	BLUE 0% - 100%
4	0 - 255	WHITE 0% - 100%
5	0 - 255	AMBER 0% - 100%
6	0 - 255	UV 0% - 100%



UB 12H		10 Channel Mode
Channel	Value	Function
1	0 - 255	RED 0% - 100%
2	0 - 255	GREEN 0% - 100%
3	0 - 255	BLUE 0% - 100%
4	0 - 255	WHITE 0% - 100%
5	0 - 255	AMBER 0% - 100%
6	0 - 255	UV 0% - 100%
7	0 - 255	COLOR MACROS (See the Color Macro Chart on page 22)
8	0 - 31 32 - 63 64 - 95 96 - 127 128 - 159 160 - 191 192 - 223 224 - 255	STROBING LED OFF LED ON STROBING SLOW - FAST LED ON PULSE STROBING SLOW - FAST LED ON RANDOM STROBING SLOW - FAST LED ON
9	0 - 255	MASTER DIMMER 0% - 100%
10	0 - 20 21 - 40 41 - 60 61 - 80 81 - 100 101 - 255	DIMMER CURVES STANDARD STAGE TV ARCHITECTURAL THEATRE DEFAULT TO UNIT SETTING

UB 12H		12 Channel Mode
Channel	Value	Function
1	0 - 255	RED 0% - 100%
2	0 - 255	GREEN 0% - 100%
3	0 - 255	BLUE 0% - 100%
4	0 - 255	WHITE 0% - 100%
5	0 - 255	AMBER 0% - 100%
6	0 - 255	UV 0% - 100%
7	0 - 255	COLOR MACROS (See the Color Macro Chart on page 22)

12 Channel Mode DMX Traits continued on the next page.

UB 12H		12 Channel Mode Cont.
Channel	Value	Function
8	0 - 15	PROGRAMS NO FUNCTION
	16 - 25	PROGRAM 1
	26 - 35	PROGRAM 2
	36 - 45	PROGRAM 3
	46 - 55	PROGRAM 4
	56 - 65	PROGRAM 5
	66 - 75	PROGRAM 6
	76 - 85	PROGRAM 7
	86 - 95	PROGRAM 8
	96 - 105	PROGRAM 9
	106 - 115	PROGRAM 10
	116 - 125	PROGRAM 11
	126 - 135	PROGRAM 12
	136 - 145	PROGRAM 13
	146 - 155	PROGRAM 14
	156 - 165	PROGRAM 15
	166 - 175	PROGRAM 16
176 - 185	PROGRAM 17	
186 - 195	PROGRAM 18	
196 - 205	PROGRAM 19	
206 - 215	PROGRAM 20	
216 - 225	PROGRAM 21	
226 - 235	PROGRAM 22	
236 - 245	AUTO RUN	
246 - 255	SOUND ACTIVE	
9	0 - 255	PROGRAM SPEED/SOUND SENSE

UB 12H		12 Channel Mode Cont.
Channel	Value	Function
10	0 - 31	STROBING LED OFF
	32 - 63	LED ON
	64 - 95	STROBING SLOW - FAST
	96 - 127	LED ON
	128 - 159	PULSE STROBING SLOW - FAST
	160 - 191	LED ON
	192 - 223	RANDOM STROBING SLOW - FAST
224 - 255	LED ON	
11	0 - 255	MASTER DIMMER 0% - 100%
12	0 - 20	DIMMER CURVES STANDARD
	21 - 40	STAGE
	41 - 60	TV
	61 - 80	ARCHITECTURAL
	81 - 100	THEATRE
	101 - 255	DEFAULT TO UNIT SETTING

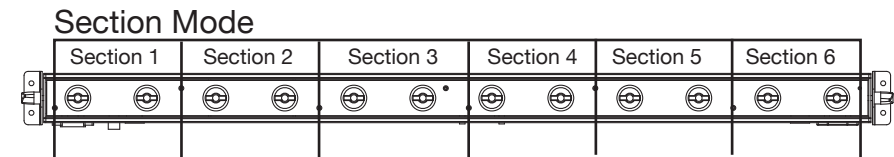

Section Mode refers to 36 Channel Mode.

UB 12H		36 Channel Mode
Channel	Value	Function
1	0 - 255	RED SECTION 1 0% - 100%
2	0 - 255	GREEN SECTION 1 0% - 100%
3	0 - 255	BLUE SECTION 1 0% - 100%
4	0 - 255	WHITE SECTION 1 0% - 100%
5	0 - 255	AMBER SECTION 1 0% - 100%
6	0 - 255	UV SECTION 1 0% - 100%
7	0 - 255	RED SECTION 2 0% - 100%
8	0 - 255	GREEN SECTION 2 0% - 100%
9	0 - 255	BLUE SECTION 2 0% - 100%
10	0 - 255	WHITE SECTION 2 0% - 100%
11	0 - 255	AMBER SECTION 2 0% - 100%
12	0 - 255	UV SECTION 2 0% - 100%
13	0 - 255	RED SECTION 3 0% - 100%
14	0 - 255	GREEN SECTION 3 0% - 100%
15	0 - 255	BLUE SECTION 3 0% - 100%
16	0 - 255	WHITE SECTION 3 0% - 100%
17	0 - 255	AMBER SECTION 3 0% - 100%
18	0 - 255	UV SECTION 3 0% - 100%

UB 12H		36 Channel Mode Cont.
Channel	Value	Function
19	0 - 255	RED SECTION 4 0% - 100%
20	0 - 255	GREEN SECTION 4 0% - 100%
21	0 - 255	BLUE SECTION 4 0% - 100%
22	0 - 255	WHITE SECTION 4 0% - 100%
23	0 - 255	AMBER SECTION 4 0% - 100%
24	0 - 255	UV SECTION 4 0% - 100%
25	0 - 255	RED SECTION 5 0% - 100%
26	0 - 255	GREEN SECTION 5 0% - 100%
27	0 - 255	BLUE SECTION 5 0% - 100%
28	0 - 255	WHITE SECTION 5 0% - 100%
29	0 - 255	AMBER SECTION 5 0% - 100%
30	0 - 255	UV SECTION 5 0% - 100%
31	0 - 255	RED SECTION 6 0% - 100%
32	0 - 255	GREEN SECTION 6 0% - 100%
33	0 - 255	BLUE SECTION 6 0% - 100%
34	0 - 255	WHITE SECTION 6 0% - 100%
35	0 - 255	AMBER SECTION 6 0% - 100%
36	0 - 255	UV SECTION 6 0% - 100%

0-3=Off	64-67=B+W	128-131=G+B+W	192-195=R+B+W+A
4-7=Red	68-71=B+A	132-135=G+B+A	196-199=R+B+W+UV
8-11=Green	72-75=B+UV	136-139=G+B+UV	200-203=R+B+A+UV
12-15=Blue	76-79=W+A	140-143=G+W+A	204-207=R+W+A+UV
16-19=White	80-83=W+UV	144-147=G+W+UV	208-211=G+B+W+A
20-23=Amber	84-87=A+UV	148-151=G+A+UV	212-215=G+B+W+UV
24-27=UV	88-91=R+G+B	152-155=B+W+A	216-219=G+B+A+UV
28-31=R+G	92-95=R+G+W	156-159=B+W+UV	220-223=G+W+A+UV
32-35=R+B	96-99=R+G+A	160-163=B+A+UV	224-227=B+W+A+UV
36-39=R+W	100-103=R+G+UV	164-167=W+A+UV	228-231=R+G+B+W+A
40-43=R+A	104-107=R+B+W	168-171=R+G+B+W	232-235=R+G+B+W+UV
44-47=R+UV	108-111=R+B+A	172-175=R+G+B+A	236-239=R+G+B+A+UV
48-51=G+B	112-115=R+B+UV	176-179=R+G+B+UV	240-243=R+G+W+A+UV
52-55=G+W	116-119=R+W+A	180-183=R+G+W+A	244-247=R+B+W+A=UV
56-59=G+A	120-123=R+W+UV	184-187=R+G+W+UV	248-251=G+B+W+A+UV
60-63=G+UV	124-127=R+A+UV	188-191=R+G+A+UV	252-255=R+G+B+W+A+UV

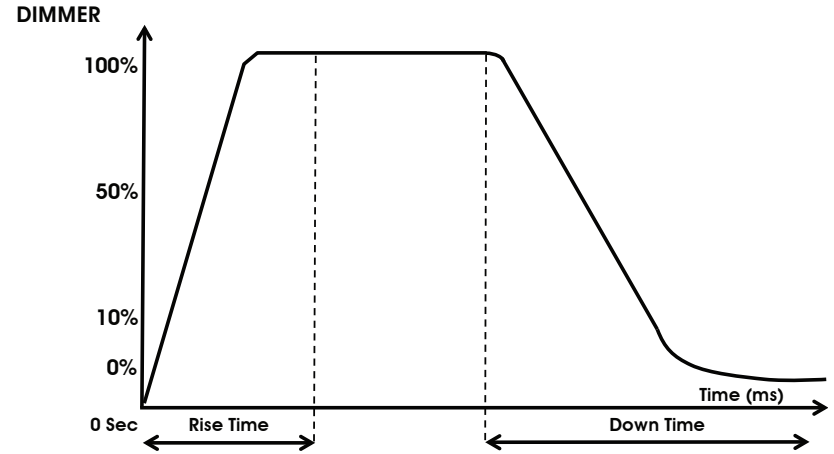

Dimming Curve Ramp Effect	0 sec Fade Time		1 sec Fade Time	
	Rise Time (ms)	Down Time (ms)	Rise Time (ms)	Down Time (ms)
Standard (default)	0	0	0	0
Stage	780	1100	1540	1660
TV	1180	1520	1860	1940
Architectural	1380	1730	2040	2120
Theatre	1580	1940	2230	2280

# UB 12H

## Dimensional Drawings

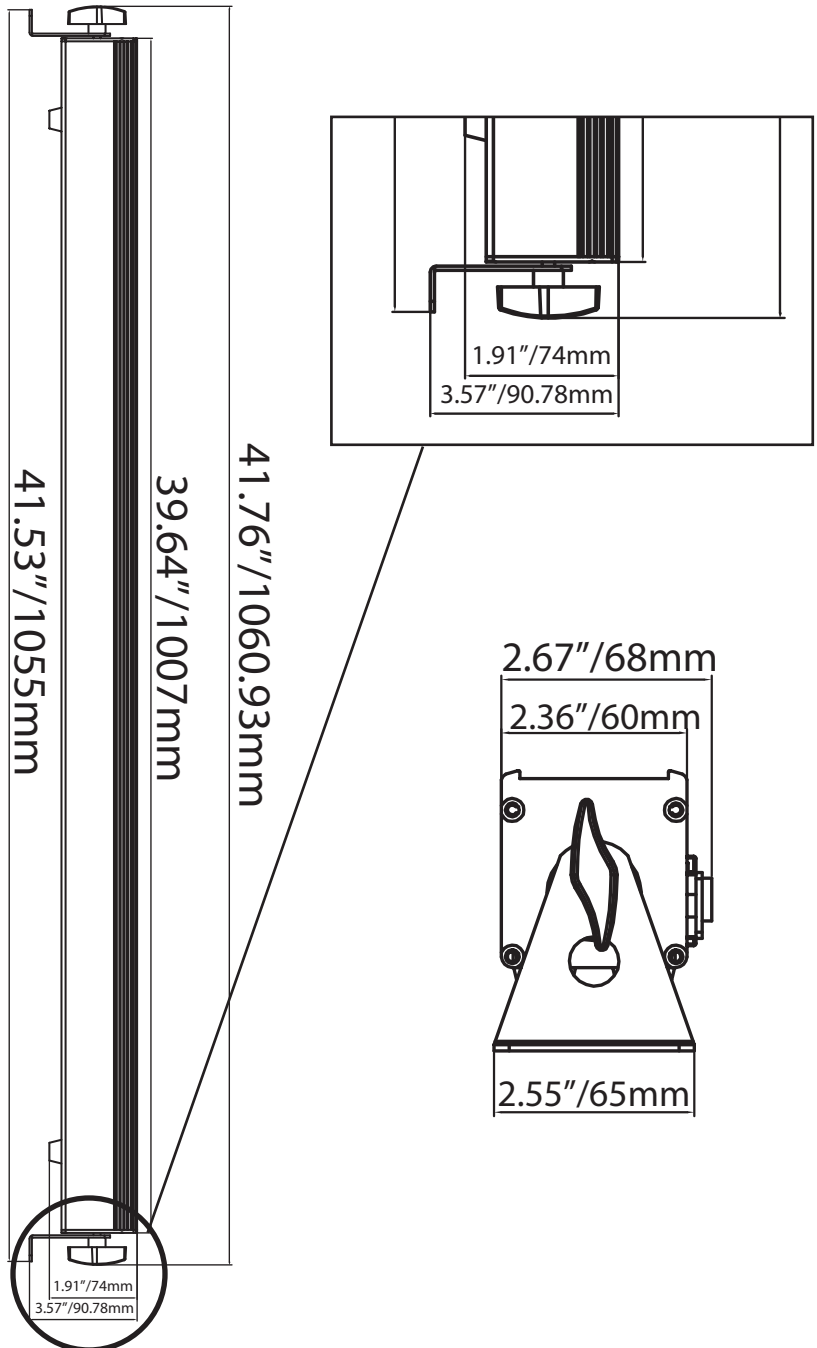

# UB 12H

## Magnetic Quick Align

This unit features a magnetic quick align feature which allows you to connect multiple fixtures securely end-to-end. This feature is exclusively used for when the fixtures are used on a flat surface such as a floor or stage for uplighting. To use this feature, unscrew the thumb screws on both ends of the fixture and remove both brackets. Position the fixtures on a flat surface and connect them end-to-end.

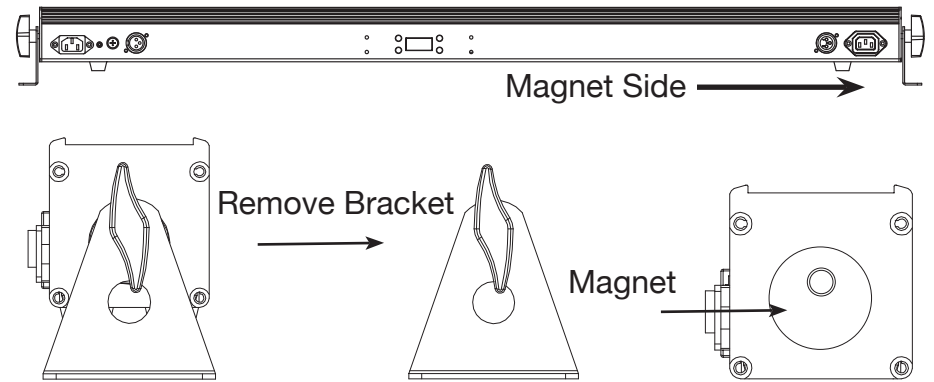



## UB 12H

## Fuse Replacement

Disconnect the unit from its power source. Remove the power cord from the unit. Use a flat head screwdriver to remove the fuse holder. Remove the fuse located inside the fuse holder and replace with the new fuse. Install the fuse holder and new fuse and secure it.

## UB 12H

## Trouble Shooting

Listed below are a few common problems the user may encounter, with solutions.

### ***Unit not responding to DMX:***

1. Check that the DMX cables are connected properly and are wired correctly (pin 3 is “hot”; on some other DMX devices pin 2 may be ‘hot’). Also, check that all cables are connected to the right connectors; it does matter which way the inputs and outputs are connected.

### ***Unit does not respond to sound:***

1. Quiet or high pitched sounds will not activate the unit.
2. Make sure that Sound Active mode is activated.

## UB 12H

## Cleaning

Due to fog residue, smoke, and dust cleaning the internal and external optical lenses must be carried out periodically to optimize light output.

1. Use normal glass cleaner and a soft cloth to wipe down the outside casing.
2. Clean the external optics with glass cleaner and a soft cloth every 20 days.
3. Always be sure to dry all parts completely before plugging the unit back in.

Cleaning frequency depends on the environment in which the fixture operates (i.e. smoke, fog residue, dust, dew).

## UB 12H

## Warranty

### MANUFACTURER'S LIMITED WARRANTY

- A. ADJ Products, LLC hereby warrants, to the original purchaser, ADJ Products, LLC products to be free of manufacturing defects in material and workmanship for a prescribed period from the date of purchase (see specific warranty period on reverse). This warranty shall be valid only if the product is purchased within the United States of America, including possessions and territories. It is the owner's responsibility to establish the date and place of purchase by acceptable evidence, at the time service is sought.
- B. For warranty service you must obtain a Return Authorization number (RA#) before sending back the product—please contact ADJ Products, LLC Service Department at 800-322-6337. Send the product only to the ADJ Products, LLC factory. All shipping charges must be pre-paid. If the requested repairs or service (including parts replacement) are within the terms of this warranty, ADJ Products, LLC will pay return shipping charges only to a designated point within the United States. If the entire instrument is sent, it must be shipped in its original package. No accessories should be shipped with the product. If any accessories are shipped with the product, ADJ Products, LLC shall have no liability whatsoever for loss of or damage to any such accessories, nor for the safe return thereof.
- C. This warranty is void if the serial number has been altered or removed; if the product is modified in any manner which ADJ Products, LLC concludes, after inspection, affects the reliability of the product; if the product has been repaired or serviced by anyone other than the ADJ Products, LLC factory unless prior written authorization was issued to purchaser by ADJ Products, LLC; if the product is damaged because not properly maintained as set forth in the instruction manual.
- D. This is not a service contract, and this warranty does not include maintenance, cleaning or periodic check up. During the period specified above, ADJ Products, LLC will replace defective parts at its expense with new or refurbished parts, and will absorb all expenses for warranty service and repair labor by reason of defects in material or workmanship. The sole responsibility of ADJ Products, LLC under this warranty shall be limited to the repair of the product, or replacement thereof, including parts, at the sole discretion of ADJ Products, LLC. All products covered by this warranty were manufactured after August 15, 2012, and bear indentifying marks to that effect.
- E. ADJ Products, LLC reserves the right to make changes in design and/or improvements upon its products without any obligation to include these changes in any products theretofore manufactured.

No warranty, whether expressed or implied, is given or made with respect to any accessory supplied with products described above. Except to the extent prohibited by applicable law, all implied warranties made by ADJ Products, LLC in connection with this product, including warranties of merchantability or fitness, are limited in duration to the warranty period set forth above. And no warranties, whether expressed or implied, including warranties of merchantability or fitness, shall apply to this product after said period has expired. The consumer's and/or Dealer's sole remedy shall be such repair or replacement as is expressly provided above; and under no circumstances shall ADJ Products, LLC be liable for any loss or damage, direct or consequential, arising out of the use of, or inability to use, this product.

This warranty is the only written warranty applicable to ADJ Products, LLC Products and supersedes all prior warranties and written descriptions of warranty terms and conditions heretofore published.

### MANUFACTURER'S LIMITED WARRANTY PERIODS:

- **Non L.E.D. Lighting Products = 1-year (365 days) Limited Warranty** (Such as: Special Effect Lighting, Intelligent Lighting, UV lighting, Strobes, Fog Machines, Bubble Machines, Mirror Balls, Par Cans, Trussing, Lighting Stands etc. excluding LED and lamps)
- **Laser Products = 1 Year (365 Days) Limited Warranty** (excluding laser diodes which have a 6 month limited warranty)
- **L.E.D. Products = 2-year (730 days) Limited Warranty** (excluding batteries which have a 180 day limited warranty). **Note: 2 Year Warranty only applies to purchases within the United States.**
- **StarTec Series = 1 Year Limited Warranty** (excluding batteries which have a 180 day limited warranty).
- **ADJ DMX Controllers = 2 Year (730 Days) Limited Warranty**



**Model: UB 12H**

Voltage:	100V ~ 240V/50~60Hz
LEDs:	12 x 6W 6-in-1 HEX LEDs
Beam Angle:	40 Degrees
Working Position:	Any safe working position
Power Draw:	85W
Power Linking:	7 Fixtures Max. @ 120V 13 Fixtures Max. @ 240V
Fuse:	2 Amp
Weight:	6lbs./ 2.7Kgs.
Dimensions:	41.75" (L) x 2.5" (W) x 3.75" (H) 1060 x 63 x 90mm
Colors:	RGBWA+UV Color Mixing
DMX Channels:	4 DMX Modes: 6 Channel Mode, 10 Channel Mode, 12 Channel Mode, & 36 Channel Mode
Warranty:	2 Year (730 days) Limited Warranty

**Please Note:** Specifications and improvements in the design of this unit and this manual are subject to change without any prior written notice.

ADJ Products, LLC  
6122 S. Eastern Ave. Los Angeles, CA 90040 USA  
Tel: 323-582-2650 / Fax: 323-725-6100  
Web: [www.adj.com](http://www.adj.com) / E-mail: [info@americandj.com](mailto:info@americandj.com)

A.D.J. Supply Europe B.V.  
Junostraat 2  
6468 EW Kerkrade  
Netherlands

Follow Us On:



[facebook.com/americandj](https://facebook.com/americandj)  
[twitter.com/americandj](https://twitter.com/americandj)  
[youtube.com/adjlighting](https://youtube.com/adjlighting)

[service@adjgroup.eu](mailto:service@adjgroup.eu) / [www.adj.com](http://www.adj.com)  
Tel: +31 45 546 85 00 / Fax: +31 45 546 85 99