



**the
t.bone**

free solo HT
UHF wireless system

Musikhaus Thomann
Thomann GmbH
Hans-Thomann-Straße 1
96138 Burgebrach
Germany
Telephone: +49 (0) 9546 9223-0
E-mail: info@thomann.de
Internet: www.thomann.de

01.10.2018, ID: 296199, 296196, 296197, ... (V7)

Table of contents

1	General information	5
	1.1 Further information.....	6
	1.2 Notational conventions.....	7
	1.3 Symbols and signal words.....	8
2	Safety instructions	9
3	Features	13
4	Installation and operation	15
	4.1 General Information.....	15
	4.2 Receiver.....	16
	4.3 Transmitter.....	18
5	Connections and controls	19
	5.1 Receiver.....	19
	5.2 Transmitter.....	27
6	Operating	31
	6.1 Receiver.....	31

6.2	Transmitter.....	34
7	Technical specifications.....	38
7.1	Transmitter.....	38
7.2	Receiver.....	40
8	Plug and connection assignment.....	42
9	Troubleshooting.....	45
10	Protecting the environment.....	48

1 General information

This manual contains important instructions for the safe operation of the unit. Read and follow the safety instructions and all other instructions. Keep the manual for future reference. Make sure that it is available to all those using the device. If you sell the unit please make sure that the buyer also receives this manual.

Our products are subject to a process of continuous development. Thus, they are subject to change.

1.1 Further information

On our website (www.thomann.de) you will find lots of further information and details on the following points:

Download	This manual is also available as PDF file for you to download.
Keyword search	Use the search function in the electronic version to find the topics of interest for you quickly.
Online guides	Our online guides provide detailed information on technical basics and terms.
Personal consultation	For personal consultation please contact our technical hotline.
Service	If you have any problems with the device the customer service will gladly assist you.

1.2 Notational conventions

This manual uses the following notational conventions:

Letterings

The letterings for connectors and controls are marked by square brackets and italics.

Examples: *[VOLUME]* control, *[Mono]* button.

Instructions

The individual steps of an instruction are numbered consecutively. The result of a step is indented and highlighted by an arrow.

Example:

- 1.** ▶ Switch on the device.
- 2.** ▶ Press *[Auto]*.
 - ⇒ Automatic operation is started.
- 3.** ▶ Switch off the device.

1.3 Symbols and signal words

In this section you will find an overview of the meaning of symbols and signal words that are used in this manual.

Signal word	Meaning
DANGER!	This combination of symbol and signal word indicates an immediate dangerous situation that will result in death or serious injury if it is not avoided.
NOTICE!	This combination of symbol and signal word indicates a possible dangerous situation that can result in material and environmental damage if it is not avoided.
Warning signs	Type of danger
	Warning – danger zone.

2 Safety instructions

Intended use

This device is intended to be used for the wireless transmission of audio signals from microphones or instruments to amplifiers or active speakers. Use the device only as described in this user manual. Any other use or use under other operating conditions is considered to be improper and may result in personal injury or property damage. No liability will be assumed for damages resulting from improper use.

This device may be used only by persons with sufficient physical, sensorial, and intellectual abilities and having corresponding knowledge and experience. Other persons may use this device only if they are supervised or instructed by a person who is responsible for their safety.

Safety



DANGER!

Danger for children

Ensure that plastic bags, packaging, etc. are disposed of properly and are not within reach of babies and young children. Choking hazard!

Ensure that children do not detach any small parts (e.g. knobs or the like) from the unit. They could swallow the pieces and choke!

Never let children unattended use electrical devices.



NOTICE!

Operating conditions

This device has been designed for indoor use only. To prevent damage, never expose the device to any liquid or moisture. Avoid direct sunlight, heavy dirt, and strong vibrations.



NOTICE!

External power supply

The device is powered by an external power supply. Before connecting the external power supply, ensure that the input voltage (AC outlet) matches the voltage rating of the device and that the AC outlet is protected by a residual current circuit breaker. Failure to do so could result in damage to the device and possibly the user.

Unplug the external power supply before electrical storms occur and when the device is unused for long periods of time to reduce the risk of electric shock or fire.



NOTICE!

Risk of fire due to incorrect polarity

Incorrectly inserted batteries may destroy the device or the batteries.

Ensure that proper polarity is observed when inserting batteries.



NOTICE!

Possible damage by leaking batteries

Leaking batteries can cause permanent damage to the device.

Take batteries out of the device if it is not going to be used for a longer period.

3 Features

The UHF wireless system is particularly suitable for professional audio transmission, for example, at events, on rock stages and in concert halls, theatres, musicals or night clubs.

Your UHF wireless system free solo HT consists of the following components:

- 9.5" Diversity receiver
 - Two antennas for optimum reception quality
 - Automatic frequency scanning
 - Infrared interface for sending the frequency selection from the receiver to the transmitter
 - Very high sensitivity at very high signal-to-noise ratio
 - Adjustable Squelch
 - Outputs: XLR, 1/4" phone socket
 - Mounting brackets for mounting in a 19" rack
 - Power supply: 12 V $\overline{\text{DC}}$ (DC), a suitable power supply is included
- Transmitter: battery powered handheld cardioid microphone

Depending on the environmental conditions, it is possible to operate six, at 823 MHz four parallel systems and to mount them in one rack.

The system operates with pre-programmed frequency groups and, depending on the version, with configurable frequency groups (user groups). The following table shows the number of available pre-programmed groups and the number of pre-programmed frequencies in each group.

Type	Pre-programmed frequency groups	Available channels per group
the t.bone free solo HT 600 MHz (item no. 296199)	14	15
the t.bone free solo HT 823 MHz (item no. 296196)	8	8
the t.bone free solo HT 863 MHz (item no. 296197)	1	16
the t.bone free solo HT 520 MHz (item no. 380965)	10	12
the t.bone free solo HT 590 MHz (item no. 380966)	16 + 2 user groups	14

4 Installation and operation

4.1 General Information

Unpack and carefully check that there is no transportation damage before using the unit. Keep the equipment packaging. To fully protect the device against vibration, dust and moisture during transportation or storage use the original packaging or your own packaging material suitable for transport or storage, respectively.

Create all connections while the device is off. Use the shortest possible high-quality cables for all connections. Take care when running the cables to prevent tripping hazards.

Notes on wireless transmission

- This device utilizes frequencies that are not harmonized within the European Union (EU) and therefore may only be used in certain EU member states. In all European countries, the frequencies used for the transmission of audio signals are strictly regulated. Before you start, make sure the frequencies are allowed in the respective country and check whether the operation must be reported to the appropriate authority.
For more information, please visit: <http://www.thomann.de>.
- Make sure that transmitter and receiver are both tuned to the same channel.
- Never set multiple transmitters to the same channel.
- Make sure that there are no metal objects between the transmitter and receiver.
- Avoid interference from other radio or in-ear systems.

4.2 Receiver

Rack mounting

The unit has been designed for rack mounting in a standard 19" rack; it occupies one rack unit. The fixing material required for assembly is included.

Connecting the power supply



NOTICE!

External power supply

The device is powered by an external power supply. Before connecting the external power supply, ensure that the input voltage (AC outlet) matches the voltage rating of the device and that the AC outlet is protected by a residual current circuit breaker. Failure to do so could result in damage to the device and possibly the user.

Unplug the external power supply before electrical storms occur and when the device is unused for long periods of time to reduce the risk of electric shock or fire.

First, connect the power adapter to the receiver and then plug the power adapter into the power outlet.

Attaching the antennas

Attach the included antennas to the rear panel of the transmitter. To improve the transmission quality and to adapt to the spatial conditions they are rotatable and swivelling.

In case the space provided on the device for direct assembly of the antennas is not sufficient, for example because the space on the rack is narrow, you can use the optionally available coaxial cable to assemble the antennas separately from the device. For larger combinations with up to four receivers, an antenna distributor is optionally available.

Connecting audio and starting up

Connect one of the audio outputs of the receiver to your mixer or your amplifier. Ensure that only one of the two outputs is ever used at a time, because faults might occur otherwise.

4.3 Transmitter

Inserting batteries into the receiver

Unscrew the bottom housing section of the hand-held microphone. Insert the batteries. Pay attention to the correct location of the poles. The correct arrangement of the batteries is indicated with symbols in the battery compartment. Close the battery compartment, screw the bottom housing section back on, and switch the transmitter on.

5 Connections and controls

5.1 Receiver

Front panel

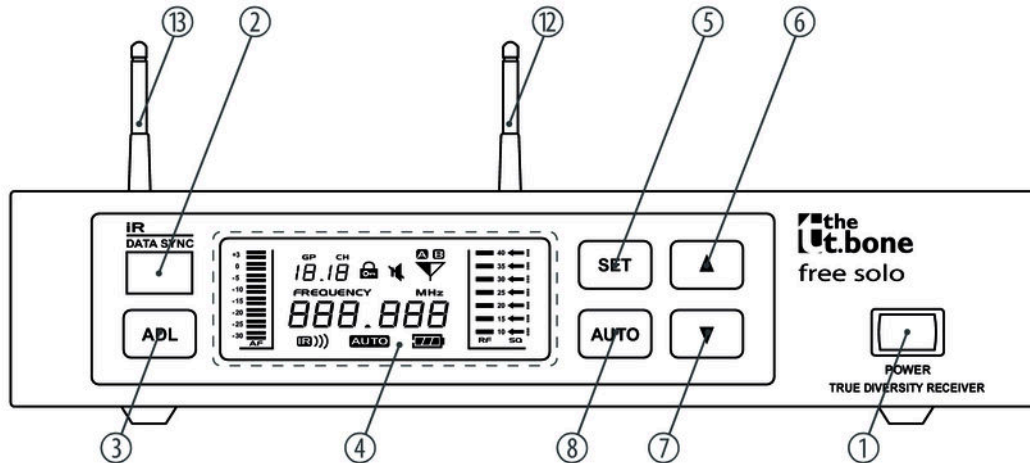

free solo HT

1	<i>[POWER]</i> Press the switch for several seconds to switch the device on or off. All previous settings are retained even when you switch the device off and disconnect it from the mains.
2	Infra red receiver.
3	<i>[ADL]</i> Starts the synchronization of the settings with the transmitter.
4	Display.
5	<i>[SET]</i> Opens the menu.
6	▲ Increases the displayed value by one.
7	▼ Decreases the displayed value by one.

8	<i>[AUTO]</i> Starts an automatic search to find a free channel.
12, 13	Suitable UHF antennas. The receiver evaluates the radio signal from both antennas and selects the signal with the higher quality for further processing.

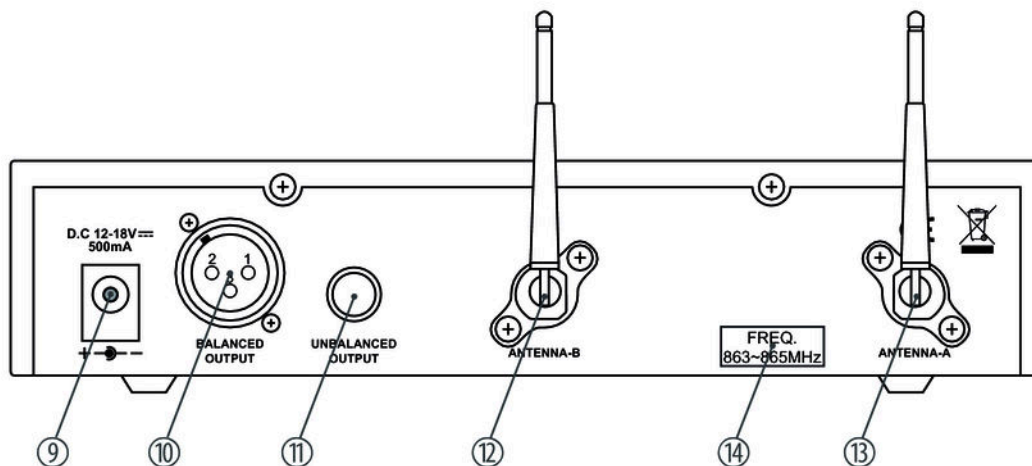

Rear panel

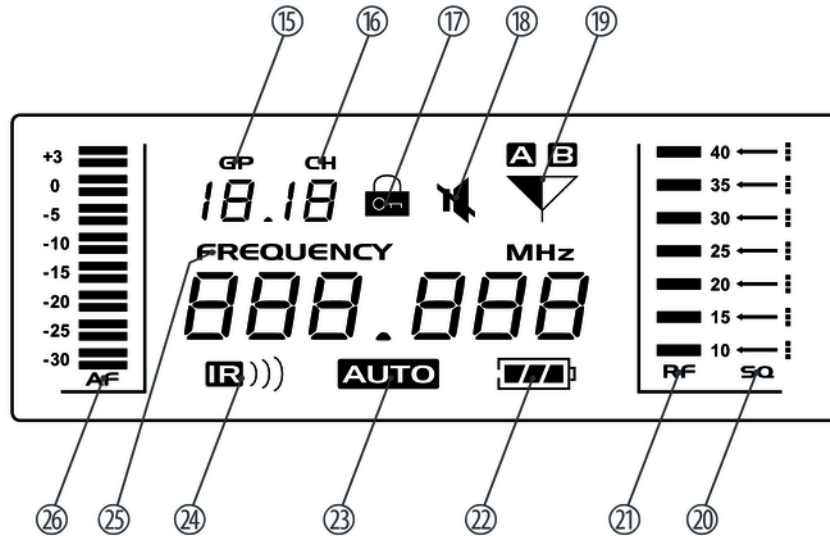

9	<p><i>[DC 12-18V]</i></p> <p>Socket for connecting the supplied AC power supply. If you are using a different power supply, observe the correct voltage, the polarity of the plug and the power consumption.</p>
10	<p><i>[BALANCED OUTPUT]</i></p> <p>Male XLR panel connector as symmetrical audio signal output for direct connection with a mixer, a power amplifier, or a recording device.</p>
11	<p><i>[UNBALANCED OUTPUT]</i></p> <p>1/4" phone socket as unbalanced audio signal output for direct connection to a mixer, a power amplifier or recording device.</p>
12, 13	<p><i>[ANTENNA-B], [ANTENNA-A]</i></p> <p>Suitable UHF antennas.</p> <p>The receiver evaluates the radio signal from both antennas and selects the signal with the higher quality for further processing.</p>
14	<p>Indicating the frequency range in which the device operates. The indication here must match the information on the transmitter.</p>

Display



15	<i>[GP]</i> Indicates the selected frequency group.
16	<i>[CH]</i> Indicates the selected channel.
17	 Indicates that the unit is locked to prevent unintentional operation.
18	 Shows that the receiver does not receive a signal, for example because the transmitter has been switched off, the connection is disturbed or the channel is currently being switched.
19	<i>[A/B]</i> Shows which of the two antennas is currently being used for signal transmission.
20	<i>[SQ]</i> Shows the set squelch level for the radio signal. Setting the squelch too will lower the dynamics of the system.
21	<i>[RF]</i> Shows the level of the radio signal received.

22	Shows the battery status of the transmitter from which the device just received a signal.
23	<i>[AUTO]</i> Shows that an automatic search is running to find a free channel.
24	<i>[IR]</i> Shows that an infra red signal is being received
25	<i>[FREQUENCY]</i> Indicates the frequency that is assigned to the set combination of frequency group and channel.
26	<i>[AF]</i> Level display for the audio signal.

5.2 Transmitter

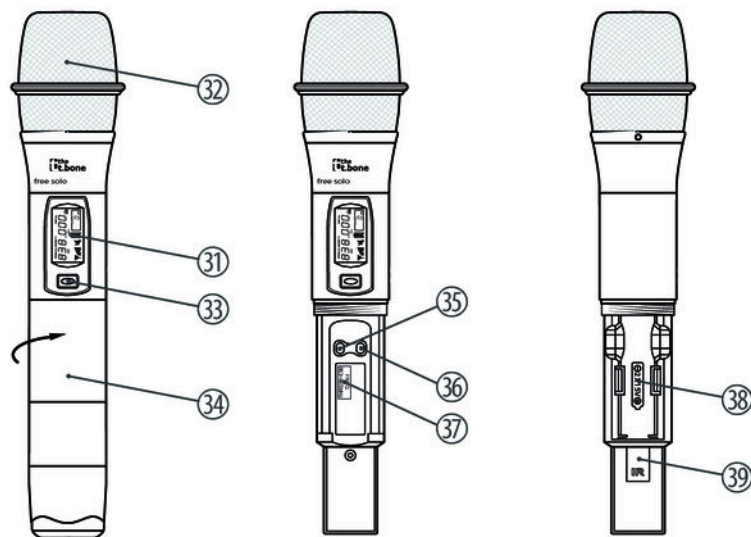

free solo HT

31	Display.
32	Microphone head grill to protect from damage and reduce wind and breathing noise.
33	Main switch Press the switch for several seconds to switch the device on or off. Press the switch once briefly to mute or unmute the microphone. When the transmitter is muted, the  symbol does not appear on the receiver display.
34	Bottom housing section. Unscrew to open.
35	<i>[SET]</i> Opens the menu.
36	<i>[SEL]</i> Selects a menu item.
37	Indicating the frequency range in which the device operates. The specification here must match the specification printed on the back of the receiver.
38	Battery holder for two round cell batteries (AA, LR06), 1.5 V or comparable rechargeable batteries.
39	Infra red sensor.



51 [FREQUENCY] / [GP] / [CH]

Depending on selected menu item:

- Indicates the frequency that is assigned to the set combination of frequency group and channel.
- Displays the set frequency group and the set channel.

52

Indicates that the unit is locked to prevent unintentional operation.

53 [GAIN]

Shows the level of the radio signal sent.

54 Battery level indicator. Replace the batteries when only one blinking bar remains displayed. Reduces the voltage of the batteries even further if the transmitter is automatically switched off. The battery status is also shown on the receiver.

55



Shows that the transmitter has been muted. This is the case if the transmitter and receiver are working on different frequencies, if the receiver is not getting a usable signal or if you have muted the transmitter by briefly pressing the main switch.

56

Shows the output power.

6 Operating

6.1 Receiver

Select frequency

- 1.** ▶ Press *[SET]*.
 - ⇒ The *[GP]* display blinks.
- 2.** ▶ Use the arrow keys to select the frequency group.
Press *[SET]* to confirm the selection.
 - ⇒ The *[CH]* display blinks.
- 3.** ▶ Use the arrow keys to select a channel within the set frequency group.
If you have selected frequency group 'U', you can use the arrow keys to set the frequency directly in 25-kHz increments. First set the value before the decimal point, and press *[SET]*. Then set the value after the decimal point.
Press *[SET]* to confirm the selection.
 - ⇒ The display shows that the receiver is being adjusted to the new frequency. After a few seconds, the display shows the normal state again.

Synchronizing transmitter and receiver

1. ▶ Open the transmitter to expose the infra red sensor.
2. ▶ Press *[ADL]*. The *[IR]* display blinks.
3. ▶ Hold the infrared sensor of the transmitter near the infrared interface of the receiver within ten seconds.
4. ▶ When synchronization has been successfully completed, the *[IR]* display stops blinking.
⇒ After three seconds, the display shows the default state again.

Set the output level.

In case of model versions for the 1.8 GHz range, you can set the output level directly with the arrow buttons.

In case of other model versions, proceed as follows:

1. ▶ Hold down *[SET]* until the *[AF]* area blinks on the display.
2. ▶ Use the arrow buttons to set the desired value. The current value is shown on the left side of the display.
3. ▶ Press *[SET]* to confirm the selection.
⇒ After three seconds, the display shows the default state again.



Setting squelch

1. ▶ Hold down *[SET]* until the *[SQ]* area blinks on the display.
2. ▶ Use the arrow buttons to set the desired value. The current value is shown on the right side of the display.
3. ▶ Press *[SET]* to confirm the selection.
 - ⇒ After three seconds, the display shows the default state again.

Automatic search for a free channel

1. ▶ Press *[AUTO]*.
 - ⇒ The *[AUTO]* display blinks; the display shows the number of free channels available.
2. ▶ Use the arrow keys to select one of the free channels.
Press *[SET]* to confirm the selection.
 - ⇒ After three seconds, the display shows the default state again.
3. ▶ If the system does not find a free channel within five seconds, it automatically returns to the default state.

Locking or unlocking the keypad

1. ▶ Hold down *[SET]* until the  symbol appears.
 - ⇒ All keys except for the main switch are locked.
2. ▶ To unlock the keypad, press *[SET]*, until the  symbol is no longer visible.
 - ⇒ The keys have their original function again.

6.2 Transmitter

The keys for operating the device are accessible if you unscrew the bottom housing section.

Select frequency

If you don't wish to synchronize the transmitter with the receiver using the infra red interface, you can set the transmitting frequency manually in the configurable frequency group (user bank).

1. ▶ Keep pressing *[SET]* until the value in the *[GP]* field blinks on the display.

2. ▶ Use *[SEL]* to select the frequency group.

Press *[SET]* to confirm the selection.

⇒ The number in the *[CH]* field blinks.

3. ▶ Use *[SEL]* to select a channel within the set frequency group.

If you have selected frequency group "U", you can use *[SEL]* to set the frequency directly. First set the value before the decimal point, and press *[SET]*. Then set the value after the decimal point.

Press *[SET]* to confirm the selection.

⇒ After a few seconds, the display shows the default state again.

Setting gain

1. ➤ Keep pressing *[SET]* until the number in the *[GAIN]* field blinks on the display.
2. ➤ Use *[SEL]* to change the transmitter gain in increments of 3 dB (-3 dB, 0 dB, 3 dB, 6 dB, 9 dB).

Press *[SET]* to confirm the selection. Press the main switch to close the menu without making any changes.

Setting transmitter power

1. ➤ Keep pressing *[SET]* until the  symbol blinks on the display.
2. ➤ Use *[SEL]* to change the transmitter power (5 mW, 10 mW, 20 mW).

Press *[SET]* to confirm the selection. Press the main switch to close the menu without making any changes.

Displaying frequency group and channel

1. ▶ Press *[SEL]*.
 - ⇒ The display shows the frequency group and channel being used.
2. ▶ Press *[SEL]* or wait five seconds to return to default state.

Locking the keypad

- ▶ Hold down *[SEL]* until the  symbol appears.
 - ⇒ All keys except for the main switch are locked.

Unlocking the keypad

- ▶ To unlock the keypad, press *[SEL]*, until the  symbol is no longer displayed.
 - ⇒ The keys have their original function again.

7 Technical specifications

7.1 Transmitter

Carrier frequency	UHF band (600 MHz...1,8 GHz)
Frequency band	the t.bone free solo HT 600 MHz (item no. 296199): 596 MHz...620 MHz
	the t.bone free solo HT 823 MHz (item no. 296196): 823 MHz...832 MHz
	the t.bone free solo HT 863 MHz (item no. 296197): 863 MHz...865 MHz
	the t.bone free solo HT 520 MHz (item no. 380965): 518 MHz...536 MHz
	the t.bone free solo HT 590 MHz (item no. 380966): 584 MHz...608 MHz
Bandwidth	the t.bone free solo HT 740 MHz (item no. 296199): 12 MHz
	the t.bone free solo HT 823 MHz (item no. 296196): 9 MHz
	the t.bone free solo HT 863 MHz (item no. 296197): 3 MHz
	the t.bone free solo HT 520 MHz (item no. 380965): 18 MHz

	the t.bone free solo HT 590 MHz (item no. 380966): 24 MHz
Switching band width	25 kHz
Modulation type	Frequency modulation (FM)
Maximum transmission power	the t.bone free solo HT 740 MHz (item no. 296199): 20 mW
	the t.bone free solo HT 823 MHz (item no. 296196): 20 mW
	the t.bone free solo HT 863 MHz (item no. 296197): 10 mW
	the t.bone free solo HT 520 MHz (item no. 380965): 20 mW
	the t.bone free solo HT 590 MHz (item no. 380966): 20 mW
Spurious response rejection ratio	> 55 dBc
Peak deviation	± 55 kHz
NF frequency response	60 Hz...18 kHz
THD	< 0.5 %
Signal-to-noise ratio	> 102 dB (A)
Voltage supply	2 AA cells (LR6, 1.5 V) or corresponding rechargeable batteries

free solo HT

Infrared connection range for synchronization between transmitter and receiver	80 mm
Operating time	> 8 h (with alkaline cells)
Dimensions (L × D)	246 mm × 53 mm
Weight	250 g

7.2 Receiver

Output	XLR chassis plug, balanced 1/4" phone socket (unbalanced)
Sensitivity	-102 dBm
NF frequency response	50 Hz...15 kHz (±3 dB)
THD	< 0.8 %
Signal-to-noise ratio	> 105 dB (A)

Voltage supply	Plug-in power supply (12 V $\overline{\text{---}}$ / 1000 mA, centre positive)
Dimensions (W \times H \times D, without antennas)	212 mm \times 44 mm \times 160 mm
Weight	900 g

Carrier frequency, frequency band, number of channels, bandwidth, switching bandwidth and modulation type correspond to those of the transmitter.

8 Plug and connection assignment

Introduction

This chapter will help you select the right cables and plugs to connect your valuable equipment in such a way that a perfect sound experience is ensured.

Please note these advices, because especially in 'Sound & Light' caution is indicated: Even if a plug fits into the socket, an incorrect connection may result in a destroyed power amp, a short circuit or 'just' in poor transmission quality!

Balanced and unbalanced transmission

Unbalanced transmission is mainly used in semi-professional environment and in hifi use. Instrument cables with two conductors (one core plus shielding) are typical representatives of the unbalanced transmission. One conductor is ground and shielding while the signal is transmitted through the core.

Unbalanced transmission is susceptible to electromagnetic interference, especially at low levels, such as microphone signals and when using long cables.

In a professional environment, therefore, the balanced transmission is preferred, because this enables an undisturbed transmission of signals over long distances. In addition to the conductors 'Ground' and 'Signal', in a balanced transmission a second core is added. This also transfers the signal, but phase-shifted by 180°.

Since the interference affects both cores equally, by subtracting the phase-shifted signals, the interfering signal is completely neutralized. The result is a pure signal without any noise interference.

1/4" TS phone plug (mono, unbalanced)



1	Signal
2	Ground, shielding

1/4" TRS phone plug (mono, balanced)



1	Signal (in phase, +)
2	Signal (out of phase, -)
3	Ground

XLR plug (balanced)

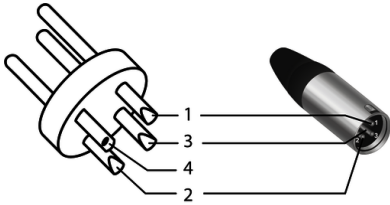

1	Ground, shielding
2	Signal (in phase, +)
3	Signal (out of phase, -)
4	Shielding on plug housing (option)

9 Troubleshooting

In the following we list a few common problems that may occur during operation. We give you some suggestions for easy troubleshooting:

Symptom	Remedy
No sound	1. Check the power supply of the transmitter and receiver.
	2. Make sure that both transmitter and receiver operate in the same frequency range. The frequency range is stated on the devices.
	3. Are both transmitter and receiver set to the same channel?
	4. Check the connection between the receiver and the connected audio device (amp, mixer). Is the connected audio device switched on and does the signal level on the output of the receiver match the input sensitivity of the audio device?
	5. Try to improve the transmission by moving the transmitter closer to the receiver.
	6. Make sure that no metal objects near the transmitter or receiver obstruct the transmission.
Transmission is disturbed	1. Modify the orientation of the antennas.
	2. If you use more than one wireless system at the same time, check the used frequencies and channels.
	3. Interference can also be caused by other radio or in-ear systems.

If the procedures recommended above do not succeed, please contact our Service Center. You can find the contact information at www.thomann.de.

10 Protecting the environment

Disposal of the packaging material



For the transport and protective packaging, environmentally friendly materials have been chosen that can be supplied to normal recycling.

Ensure that plastic bags, packaging, etc. are properly disposed of.

Do not just dispose these materials with your normal household waste, but make sure that they are fed to a recovery. Please follow the notes and markings on the packaging.

Disposal of batteries



Batteries must not be disposed of as domestic waste or thrown into fire. Dispose of the batteries according to national or local regulations regarding hazardous waste. To protect the environment, dispose of empty batteries at your retail store or at appropriate collection sites.

Disposal of your old device



This product is subject to the European Waste Electrical and Electronic Equipment Directive (WEEE) in its currently valid version. Do not dispose with your normal household waste.

Dispose this device through an approved waste disposal firm or through your local waste facility. When discarding the device, comply with the rules and regulations that apply in your country. If in doubt, consult your local waste disposal facility.



Musikhaus Thomann · Hans-Thomann-Straße 1 · 96138 Burgebrach · Germany · www.thomann.de